

# NTC GAS COOLER

Technical Guide



## TABLE OF CONTENTS

Overview.....	2, 3
Features & Options.....	3, 4
Nomenclature.....	3
One Solution.....	4

### Gas Cooler Information

Performance Data .....	5-6
Specifications.....	7-10
Unit Weight .....	11-14
Sound Data.....	15

### Additional Information

Dimensions.....	16
Typical Gas Cooler Wiring Diagrams .....	17-18

*Since product improvement is a continuing effort, we reserve the right to make changes in specifications without notice.*



## OVERVIEW

To meet the growing demand of CO2 systems and to offer our customers a suite of product solutions to meet Low GWP regulations, Heatcraft Refrigeration is proud to offer the NTC Gas Cooler product line specifically designed to be used in transcritical CO2 applications. The NTC gas cooler line offers our customers ample capacity range from 10 to 275 tons to satisfy an array of applications and uses the latest variable speed motor technology to provide critical sound and energy performance where significant energy savings are essential.

The gas cooler product line is offered standard with an unpainted galvanized steel cabinet with housings available in painted galvanized steel or aluminum finish. Drawing from our successful line of NTC products, an extensive list of options is available to match the most rigid application requirements.

The NTC gas cooler is offered in single or double wide fan configurations.



*Venturi VSEC Mounted Motor Technology*

## FEATURES

The NTC gas cooler is designed with features to meet specific customer requirements.

### Standard Features include:

- EBM EC Variable Speed motor, swept fan blade with integrated Venturi
- Broad capacity range from 10 to 275 tons
- 10 FPI coil
- Galvanized steel cabinet is standard with painted galvanized steel or aluminum housing available as an option
- Side access panels for ease of cleaning coils
- Non-fused, through-the-door disconnect
- All models with 10 or more fans will have an oversized e-box
- UL and UL listed for Canada
- Coil design pressure is 1886psig and UL listed



*The Floating Tube Coil Design  
Dramatically Reduces Tube Sheet Leaks*

## NOMENCLATURE

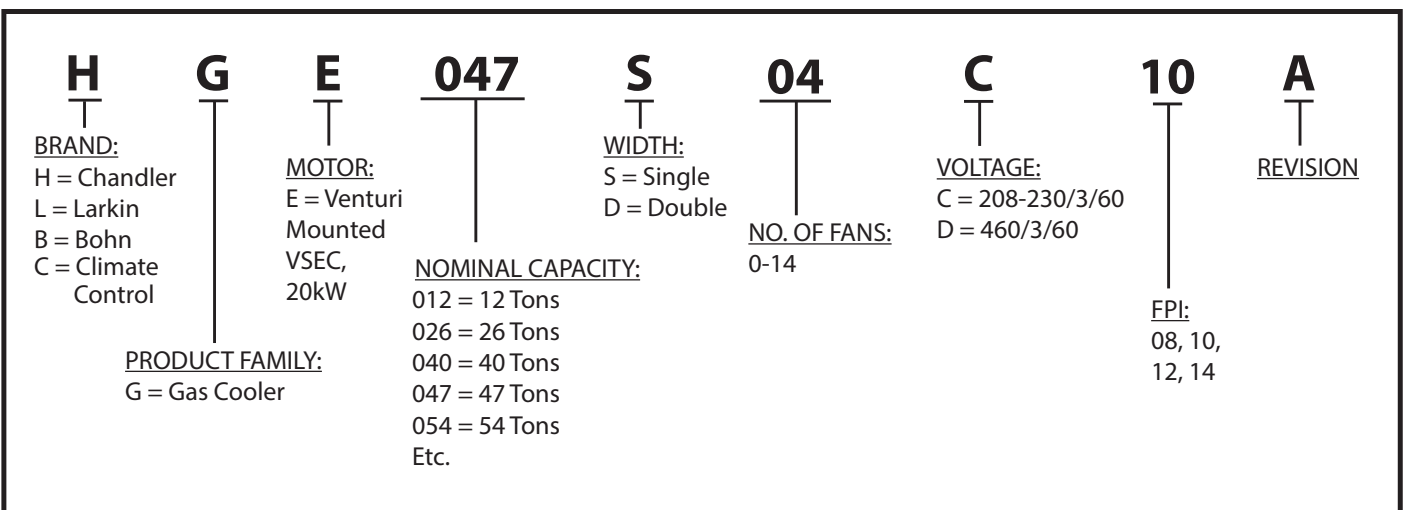

### Notes:

Please consult your Sales Representative for 575/3/60 application requirements

## One Solution Tailored To Fit Your Unique Needs

The NTC gas cooler line offers a wide range of options and cabinet finishes. Choose the configuration that best fits the need of the application

FEATURE	VENTURI MOUNTED VSEC
<b>Motors</b>	
Standard Motor	Variable Speed EC Motors
<b>Cabinet</b>	
Standard Cabinet	Galvanized Steel
Pre-Painted Galvanized Option	✓
Aluminum Option	✓
<b>Venturi Cover</b>	
Standard Venturi	EC Tall Optimized
Hinged Option	-
<b>Fan Blades</b>	
Standard Blade	EC Optimized
<b>Motor Mounted</b>	
Standard Motor Mounted	EC Optimized
<b>Warranty</b>	
Two-Year Warranty - Unit	✓
Three-Year Warranty - Venturi Mounted VSEC Motors	✓
Five-Year Warranty - Floating Tube™ Coil Design	✓

## PERFORMANCE DATA

Table 7.

Model	Fans	Rows	Capacity in Ton @ 95 ambient, 99 Gas outlet, 239F, 1358 PSI gas inlet			
			8 FPI	10 FPI	12 FPI	14 FPI
HGE012S01^*A	1	4	10	<b>12</b>	13	14
HGE026S02^*A	2	4	25	<b>26</b>	29	32
HGE040S03^*A	3	4	33	<b>40</b>	43	46
HGE047S04^*A	4	4	46	<b>47</b>	52	56
HGE064S05^*A	5	4	54	<b>64</b>	68	74
HGE079S06^*A	6	4	67	<b>79</b>	86	93
HGE094S07^*A	7	4	80	<b>94</b>	102	112
HGE053D04^*A	4	4	49	<b>53</b>	58	63
HGE079D06^*A	6	4	67	<b>79</b>	86	93
HGE094D08^*A	8	4	93	<b>94</b>	103	112
HGE128D10^*A	10	4	108	<b>128</b>	136	148
HGE158D12^*A	12	4	134	<b>158</b>	171	186
HGE189D14^*A	14	4	159	<b>189</b>	205	223

**BOLD** indicates standard model capacity.

NOTES:

^ = Electrical Code Designator (see Nomenclature details)

\* = Fins Per Inch (see Nomenclature details)

## PERFORMANCE DATA

Table 8.

Model	Fans	Rows	Capacity in Ton @ 95 ambient, 99 Gas outlet, 239F, 1358 PSI gas inlet			
			8 FPI	10 FPI	12 FPI	14 FPI
HGE017S01^*A	1	6	15	<b>17</b>	19	20
HGE035S02^*A	2	6	31	<b>35</b>	38	40
HGE052S03^*A	3	6	45	<b>52</b>	56	59
HGE069S04^*A	4	6	63	<b>69</b>	75	80
HGE089S05^*A	5	6	78	<b>89</b>	97	102
HGE101S06^*A	6	6	89	<b>101</b>	110	116
HGE121S07^*A	7	6	106	<b>121</b>	131	138
HGE069D04^*A	4	6	62	<b>69</b>	76	80
HGE103D06^*A	6	6	90	<b>103</b>	112	119
HGE138D08^*A	8	6	125	<b>138</b>	151	160
HGE178D10^*A	10	6	156	<b>178</b>	194	204
HGE202D12^*A	12	6	177	<b>202</b>	220	232
HGE241D14^*A	14	6	212	<b>241</b>	262	275

**BOLD** indicates standard model capacity.

NOTES:

^ = Electrical Code Designator (see Nomenclature details)

\* = Fins Per Inch (see Nomenclature details)

## SPECIFICATIONS

**Table 9.**

Model	Fans	CFM	Internal volume (ft <sup>3</sup> )	208-230/3/60hz			Unit kW	Estimated Charge	Conn. (in.)	Max. No. of Feeds
				FLA	MCA	MOPD				
HGE012S01 <sup>^</sup> *A	1	10,500	0.295	7	15	25	2	9.2	1-1/8	7
HGE026S02 <sup>^</sup> *A	2	20,900	0.578	14	20	35	4	18.0	1-1/8	14
HGE040S03 <sup>^</sup> *A	3	31,400	0.861	21	22.8	40	6	26.8	1-1/8	14
HGE047S04 <sup>^</sup> *A	4	42,000	1.142	28	29.8	45	8	35.5	1-1/8	28
HGE064S05 <sup>^</sup> *A	5	52,500	1.426	35	36.8	50	10	44.3	1-1/8	28
HGE079S06 <sup>^</sup> *A	6	63,000	1.709	42	43.8	60	12	53.1	1-1/8	28
HGE094S07 <sup>^</sup> *A	7	73,500	1.992	49	50.8	70	14	61.9	1-5/8	54
HGE053D04 <sup>^</sup> *A	4	41,800	1.156	28	29.8	45	8	36.0	2 x 1-1/8	2 x 14
HGE079D06 <sup>^</sup> *A	6	62,800	1.721	42	43.8	60	12	53.5	2 x 1-1/8	2 x 14
HGE094D08 <sup>^</sup> *A	8	84,000	2.285	56	57.8	70	16	71.0	2 x 1-1/8	2 x 28
HGE128D10 <sup>^</sup> *A	10	105,000	2.851	70	71.8	90	20	88.7	2 x 1-1/8	2 x 28
HGE158D12 <sup>^</sup> *A	12	126,000	3.418	84	85.8	100	24	106.3	2 x 1-1/8	2 x 28
HGE189D14 <sup>^</sup> *A	14	147,000	3.984	98	99.8	110	28	123.9	2 x 1-5/8	2 x 54

**NOTES:**

<sup>^</sup> = Electrical Code Designator (see Nomenclature details)

\* = Fins Per Inch (see Nomenclature details)

## SPECIFICATIONS

Table 10.

Model	Fans	CFM	Internal volume (ft <sup>3</sup> )	460/3/60hz			Unit kW	Estimated Charge	Conn. (in.)	Max. No. of Feeds
				FLA	MCA	MOPD				
HGE012S01 <sup>^</sup> *A	1	10,500	0.295	3.5	15	15	2	9.2	1-1/8	7
HGE026S02 <sup>^</sup> *A	2	20,900	0.578	7	15	15	4	18.0	1-1/8	14
HGE040S03 <sup>^</sup> *A	3	31,400	0.861	10.5	15	20	6	26.8	1-1/8	14
HGE047S04 <sup>^</sup> *A	4	42,000	1.142	14	15	20	8	35.5	1-1/8	28
HGE064S05 <sup>^</sup> *A	5	52,500	1.426	17.5	20	25	10	44.3	1-1/8	28
HGE079S06 <sup>^</sup> *A	6	63,000	1.709	21	21.9	30	12	53.1	1-1/8	28
HGE094S07 <sup>^</sup> *A	7	73,500	1.992	24.5	25.4	35	14	61.9	1-5/8	54
HGE053D04 <sup>^</sup> *A	4	41,800	1.156	14	15	20	8	36.0	2 x 1-1/8	2 x 14
HGE079D06 <sup>^</sup> *A	6	62,800	1.721	21	21.9	30	12	53.5	2 x 1-1/8	2 x 14
HGE094D08 <sup>^</sup> *A	8	84,000	2.285	28	28.9	35	16	71.0	2 x 1-1/8	2 x 28
HGE128D10 <sup>^</sup> *A	10	105,000	2.851	35	35.9	45	20	88.7	2 x 1-1/8	2 x 28
HGE158D12 <sup>^</sup> *A	12	126,000	3.418	42	42.9	50	24	106.3	2 x 1-1/8	2 x 28
HGE189D14 <sup>^</sup> *A	14	147,000	3.984	49	49.9	60	28	123.9	2 x 1-5/8	2 x 54

NOTES:

<sup>^</sup> = Electrical Code Designator (see Nomenclature details)

\* = Fins Per Inch (see Nomenclature details)



# SPECIFICATIONS

**Table 11.**

Model	Fans	CFM	Internal volume (ft <sup>3</sup> )	208-230/3/60hz			Unit kW	Estimated Charge	Conn. (in.)	Max. No. of Feeds
				FLA	MCA	MOPD				
HGE017S01 <sup>^</sup> *A	1	9,660	0.443	7	15	25	2	13.77	1-1/8	7
HGE035S02 <sup>^</sup> *A	2	19,220	0.867	14	20	35	4	26.96	1-1/8	14
HGE052S03 <sup>^</sup> *A	3	28,880	1.291	21	22.8	40	6	40.15	1-1/8	21
HGE069S04 <sup>^</sup> *A	4	38,640	1.715	28	29.8	45	8	53.34	1-1/8	28
HGE089S05 <sup>^</sup> *A	5	48,300	2.140	35	36.8	50	10	66.55	1-5/8	42
HGE101S06 <sup>^</sup> *A	6	57,960	2.563	42	43.8	60	12	79.71	1-5/8	42
HGE121S07 <sup>^</sup> *A	7	67,620	2.988	49	50.8	70	14	92.92	1-5/8	42
HGE069D04 <sup>^</sup> *A	4	38,440	1.734	28	29.8	45	8	53.92	2 x 1-1/8	2 x 14
HGE103D06 <sup>^</sup> *A	6	57,760	2.582	42	43.8	60	12	80.30	2 x 1-1/8	2 x 21
HGE138D08 <sup>^</sup> *A	8	77,280	3.430	56	57.8	70	16	106.67	2 x 1-1/8	2 x 28
HGE178D10 <sup>^</sup> *A	10	96,600	4.280	70	71.8	90	20	133.09	2 x 1-5/8	2 x 42
HGE202D12 <sup>^</sup> *A	12	115,920	5.126	84	85.8	100	24	159.42	2 x 1-5/8	2 x 42
HGE241D14 <sup>^</sup> *A	14	135,240	5.976	98	99.8	110	28	185.84	2 x 1-5/8	2 x 42

**NOTES:**

<sup>^</sup> = Electrical Code Designator (see Nomenclature details)

\* = Fins Per Inch (see Nomenclature details)

# SPECIFICATIONS

**Table 12.**

Model	Fans	CFM	Internal volume (ft <sup>3</sup> )	460/3/60hz			Unit kW	Estimated Charge	Conn. (in.)	Max. No. of Feeds
				FLA	MCA	MOPD				
HGE017S01 <sup>^</sup> *A	1	9,660	0.443	3.5	15	15	2	13.77	1-1/8	7
HGE035S02 <sup>^</sup> *A	2	19,220	0.867	7	15	15	4	26.96	1-1/8	14
HGE052S03 <sup>^</sup> *A	3	28,880	1.291	10.5	15	20	6	40.15	1-1/8	21
HGE069S04 <sup>^</sup> *A	4	38,640	1.715	14	15	20	8	53.34	1-1/8	28
HGE089S05 <sup>^</sup> *A	5	48,300	2.140	17.5	20	25	10	66.55	1-5/8	42
HGE101S06 <sup>^</sup> *A	6	57,960	2.563	21	21.9	30	12	79.71	1-5/8	42
HGE121S07 <sup>^</sup> *A	7	67,620	2.988	24.5	25.4	35	14	92.92	1-5/8	42
HGE069D04 <sup>^</sup> *A	4	38,440	1.734	14	15	20	8	53.92	2 x 1-1/8	2 x 14
HGE103D06 <sup>^</sup> *A	6	57,760	2.582	21	21.9	30	12	80.30	2 x 1-1/8	2 x 21
HGE138D08 <sup>^</sup> *A	8	77,280	3.430	28	28.9	35	16	106.67	2 x 1-1/8	2 x 28
HGE178D10 <sup>^</sup> *A	10	96,600	4.280	35	35.9	45	20	133.09	2 x 1-5/8	2 x 42
HGE202D12 <sup>^</sup> *A	12	115,920	5.126	42	42.9	50	24	159.42	2 x 1-5/8	2 x 42
HGE241D14 <sup>^</sup> *A	14	135,240	5.976	49	49.9	60	28	185.84	2 x 1-5/8	2 x 42

**NOTES:**

<sup>^</sup> = Electrical Code Designator (see Nomenclature details)

\* = Fins Per Inch (see Nomenclature details)

## UNIT WEIGHT

Table 13.

Model	Fans	Rows	Estimated Net Weight (lbs)			
			8 FPI	10 FPI	12 FPI	14 FPI
HGE012S01^*A	1	4	390	<b>400</b>	420	430
HGE026S02^*A	2	4	740	<b>760</b>	790	820
HGE040S03^*A	3	4	1090	<b>1120</b>	1160	1200
HGE047S04^*A	4	4	1420	<b>1470</b>	1530	1580
HGE064S05^*A	5	4	1780	<b>1840</b>	1910	1970
HGE079S06^*A	6	4	2120	<b>2190</b>	2270	2350
HGE094S07^*A	7	4	2460	<b>2550</b>	2650	2740
HGE053D04^*A	4	4	1590	<b>1640</b>	1700	1750
HGE079D06^*A	6	4	2370	<b>2440</b>	2520	2600
HGE094D08^*A	8	4	3130	<b>3230</b>	3340	3440
HGE128D10^*A	10	4	3910	<b>4040</b>	4170	4300
HGE158D12^*A	12	4	4680	<b>4830</b>	4990	5150
HGE189D14^*A	14	4	5450	<b>5630</b>	5820	6000

**BOLD** indicates standard model capacity.

NOTES:

^ = Electrical Code Designator (see Nomenclature details)

\* = Fins Per Inch (see Nomenclature details)

## UNIT WEIGHT

Table 13.

Model	Fans	Rows	Estimated Shipping Weight (lbs)			
			8 FPI	10 FPI	12 FPI	14 FPI
HGE012S01^*A	1	4	530	<b>540</b>	560	570
HGE026S02^*A	2	4	960	<b>980</b>	1010	1040
HGE040S03^*A	3	4	1390	<b>1420</b>	1460	1500
HGE047S04^*A	4	4	1810	<b>1860</b>	1920	1970
HGE064S05^*A	5	4	2240	<b>2300</b>	2370	2430
HGE079S06^*A	6	4	2670	<b>2740</b>	2820	2900
HGE094S07^*A	7	4	3090	<b>3180</b>	3280	3370
HGE053D04^*A	4	4	1810	<b>1860</b>	1920	1970
HGE079D06^*A	6	4	2670	<b>2740</b>	2820	2900
HGE094D08^*A	8	4	3520	<b>3620</b>	3730	3830
HGE128D10^*A	10	4	4370	<b>4500</b>	4630	4760
HGE158D12^*A	12	4	5230	<b>5380</b>	5540	5700
HGE189D14^*A	14	4	6080	<b>6260</b>	6450	6630

**BOLD** indicates standard model capacity.

NOTES:

^ = Electrical Code Designator (see Nomenclature details)

\* = Fins Per Inch (see Nomenclature details)

## UNIT WEIGHT

Table 13.

Model	Fans	Rows	Estimated Net Weight (lbs)			
			8 FPI	10 FPI	12 FPI	14 FPI
HGE017S01^*A	1	6	470	<b>480</b>	500	520
HGE035S02^*A	2	6	880	<b>910</b>	950	990
HGE052S03^*A	3	6	1290	<b>1340</b>	1400	1460
HGE069S04^*A	4	6	1690	<b>1760</b>	1840	1920
HGE089S05^*A	5	6	2110	<b>2200</b>	2300	2400
HGE101S06^*A	6	6	2510	<b>2620</b>	2740	2860
HGE121S07^*A	7	6	2920	<b>3050</b>	3190	3330
HGE069D04^*A	4	6	1860	<b>1930</b>	2010	2090
HGE103D06^*A	6	6	2760	<b>2870</b>	2990	3110
HGE138D08^*A	8	6	3660	<b>3810</b>	3970	4130
HGE178D10^*A	10	6	4570	<b>4760</b>	4960	5150
HGE202D12^*A	12	6	5470	<b>5700</b>	5940	6170
HGE241D14^*A	14	6	6370	<b>6640</b>	6920	7190

**BOLD** indicates standard model capacity.

NOTES:

^ = Electrical Code Designator (see Nomenclature details)

\* = Fins Per Inch (see Nomenclature details)

## UNIT WEIGHT

Table 13.

Model	Fans	Rows	Estimated Shipping Weight (lbs)			
			8 FPI	10 FPI	12 FPI	14 FPI
HGE017S01 <sup>^</sup> *A	1	6	600	<b>610</b>	630	650
HGE035S02 <sup>^</sup> *A	2	6	1090	<b>1120</b>	1160	1200
HGE052S03 <sup>^</sup> *A	3	6	1590	<b>1640</b>	1700	1760
HGE069S04 <sup>^</sup> *A	4	6	2080	<b>2150</b>	2230	2310
HGE089S05 <sup>^</sup> *A	5	6	2570	<b>2660</b>	2760	2860
HGE101S06 <sup>^</sup> *A	6	6	3060	<b>3170</b>	3290	3410
HGE121S07 <sup>^</sup> *A	7	6	3560	<b>3690</b>	3830	3970
HGE069D04 <sup>^</sup> *A	4	6	2080	<b>2150</b>	2230	2310
HGE103D06 <sup>^</sup> *A	6	6	3060	<b>3170</b>	3290	3410
HGE138D08 <sup>^</sup> *A	8	6	4050	<b>4200</b>	4360	4520
HGE178D10 <sup>^</sup> *A	10	6	5030	<b>5220</b>	5420	5610
HGE202D12 <sup>^</sup> *A	12	6	6020	<b>6250</b>	6490	6720
HGE241D14 <sup>^</sup> *A	14	6	7000	<b>7270</b>	7550	7820

**BOLD** indicates standard model capacity.

NOTES:

<sup>^</sup> = Electrical Code Designator (see Nomenclature details)

\* = Fins Per Inch (see Nomenclature details)

## Chandler Venturi Mounted VSEC Series

The Chandler NTC Gas Cooler incorporates Venturi Mounted VSEC motor technology to provide the quietest and most efficient condensers in the industry, using integrated variable speed technology.

### Simplicity: Variable speed without the complexity

The Chandler NTC gas cooler incorporates a VSEC motor, integrated drive and control electronics, optimized swept motor blade and venturi panel in one simple package. Variable speed is accomplished without the complexities typically associated with Variable Frequency Drives (VFD).

### Flexibility: Maximum efficiency, minimum sound, capacity when you need it

The Venturi Mounted VSEC integrated variable speed capability allows optimization to your operating conditions; at higher speeds on hot summer afternoons to maintain capacity or at lower speeds at night to meet a local sound ordinance. Whatever your requirements, the Chandler NTC Gas Cooler VSEC can be selected and programmed to your specific needs; whether it is lower energy costs, lower sound or both.

### Reliability: The highest quality backed by industry-leading warranties

We are so confident in the reliability of the VSEC motor that we are providing an unprecedented 3-year warranty on the VSEC motor (2-year warranty on the unit) so you can be assured of worry-free operation.

### Protection at every level

The VSEC motors have several built-in features that protect against locked-rotors, under-voltage and phase failure.

### Variable Speed Operation

Variable speed motors provide variable speed operation automatically; providing dramatically lower sound and energy levels than would be observed with comparable equipment using traditional AC motors.

### Control Panels for Electronic Controllers

Custom control panels can often be fabricated to interface with many of the microprocessor based electronic refrigeration controls. These panels often include individual motor fusing, individual fan motor contactors, splitting relays and printed circuit boards to interface with the microprocessor control. Contact the factory with your specific requirements.

## EC Sound Data (dBA @ 10 ft.)

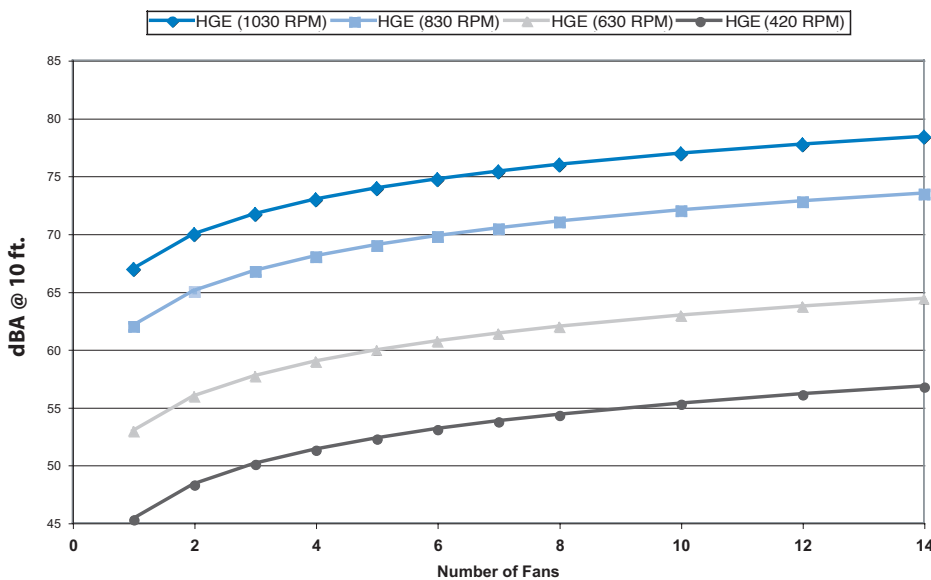

Fans	HGE 1030 RPM	HGE 830 RPM	HGE 630 RPM	HGE 420 RPM
1	66.9	62.0	52.9	45.3
2	69.9	65.0	55.9	48.3
3	71.7	66.8	57.7	50.1
4	72.9	68.0	58.9	51.3
5	73.9	69.0	59.9	52.3
6	74.7	69.8	60.7	53.1
7	75.4	70.5	61.4	53.8
8	75.9	71.0	61.9	54.3
10	76.9	72.0	62.9	55.3
12	77.7	72.8	63.7	56.1
14	78.4	73.5	64.4	56.8

# GAS COOLER DIMENSIONS

## End Views

Single Row of Fans

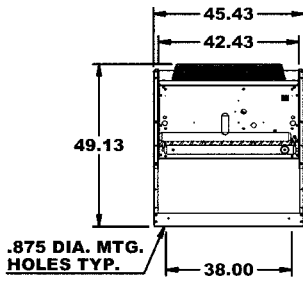

Double Row of Fans

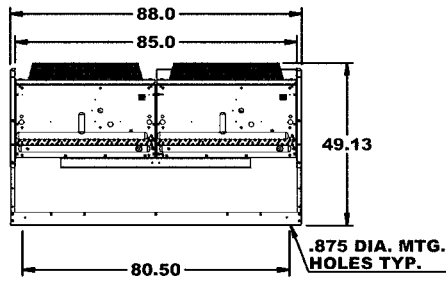

## Side Views

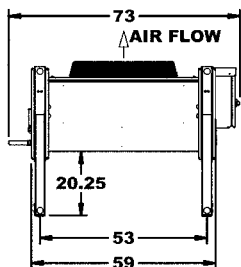

1 x 1

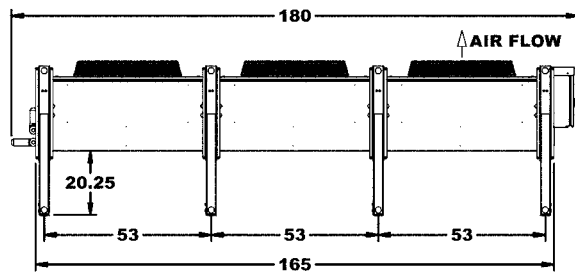

1 x 3  
2 x 3

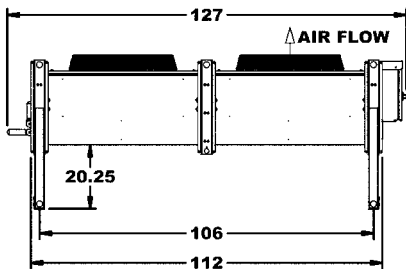

1 x 2  
2 x 2

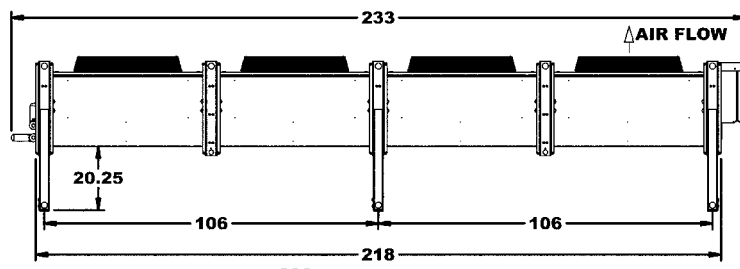

1 x 4  
2 x 4

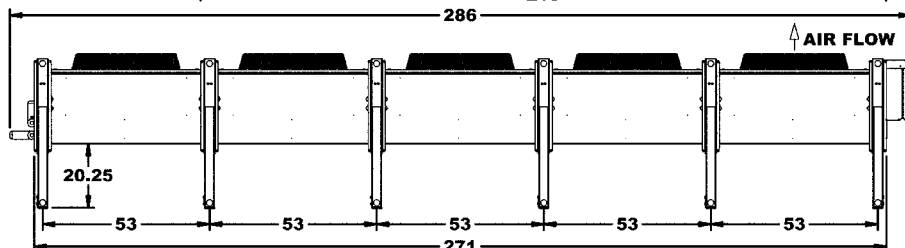

1 x 5  
2 x 5

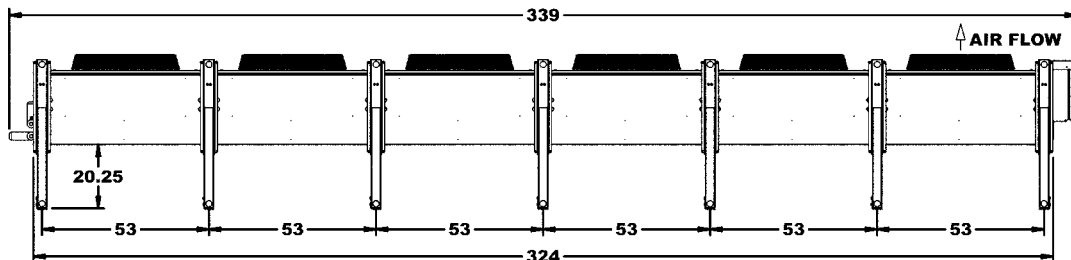

1 x 6  
2 x 6

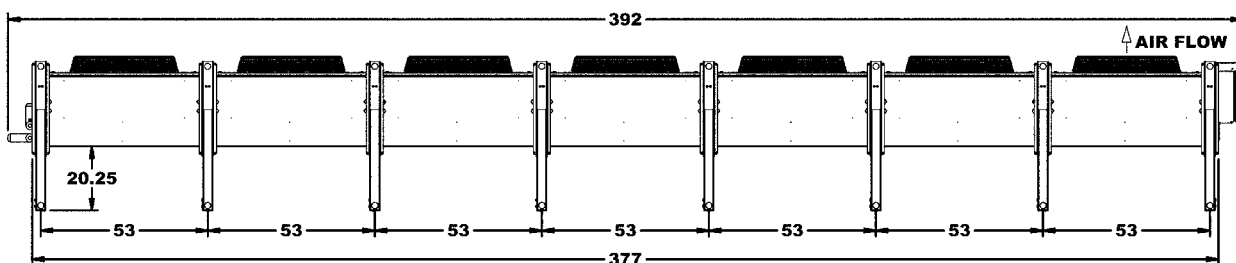

1 x 7  
2 x 7



# Diagram 1. Gas Cooler Wiring Diagrams

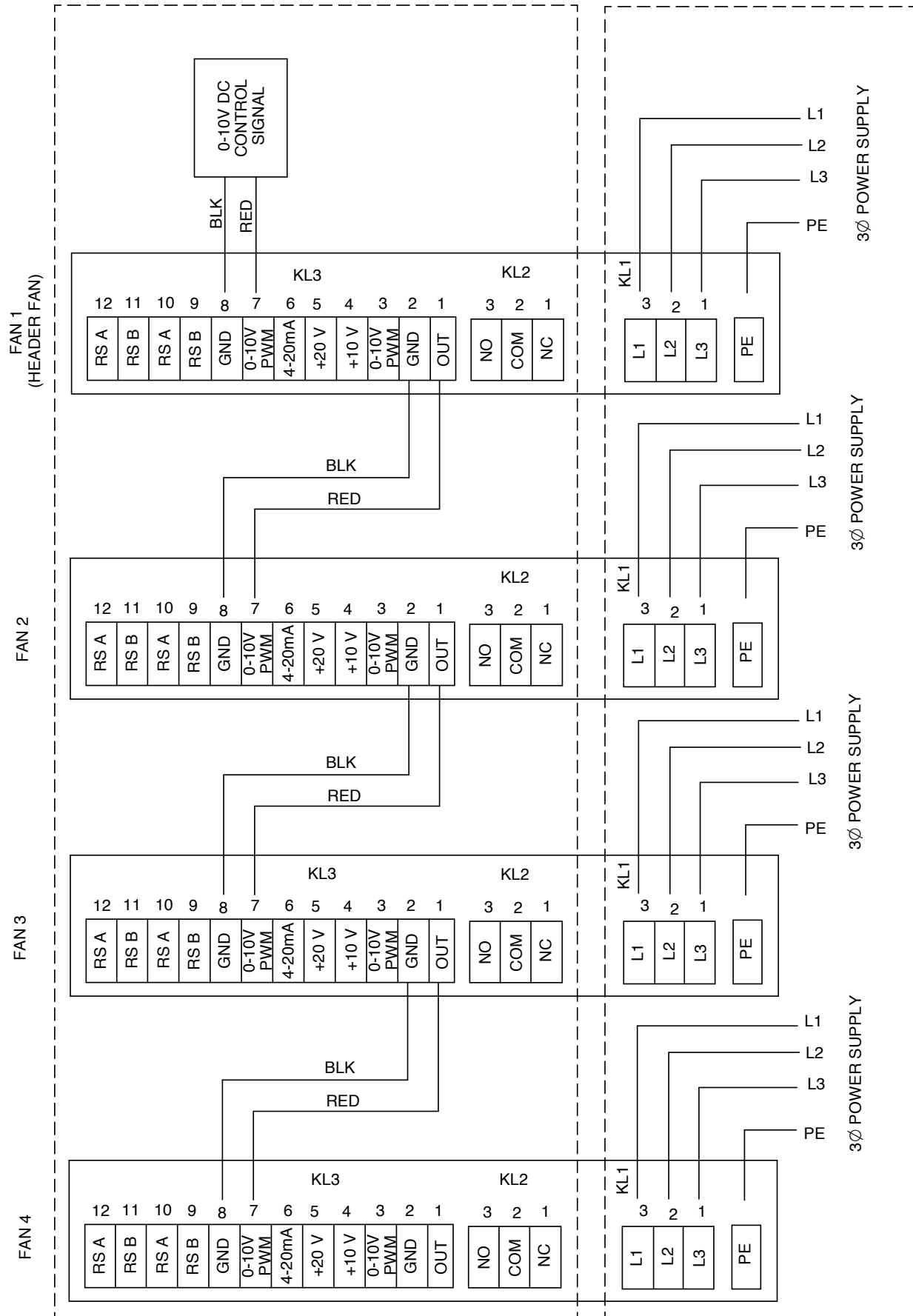

## Diagram 2. Gas Cooler Wiring Diagrams

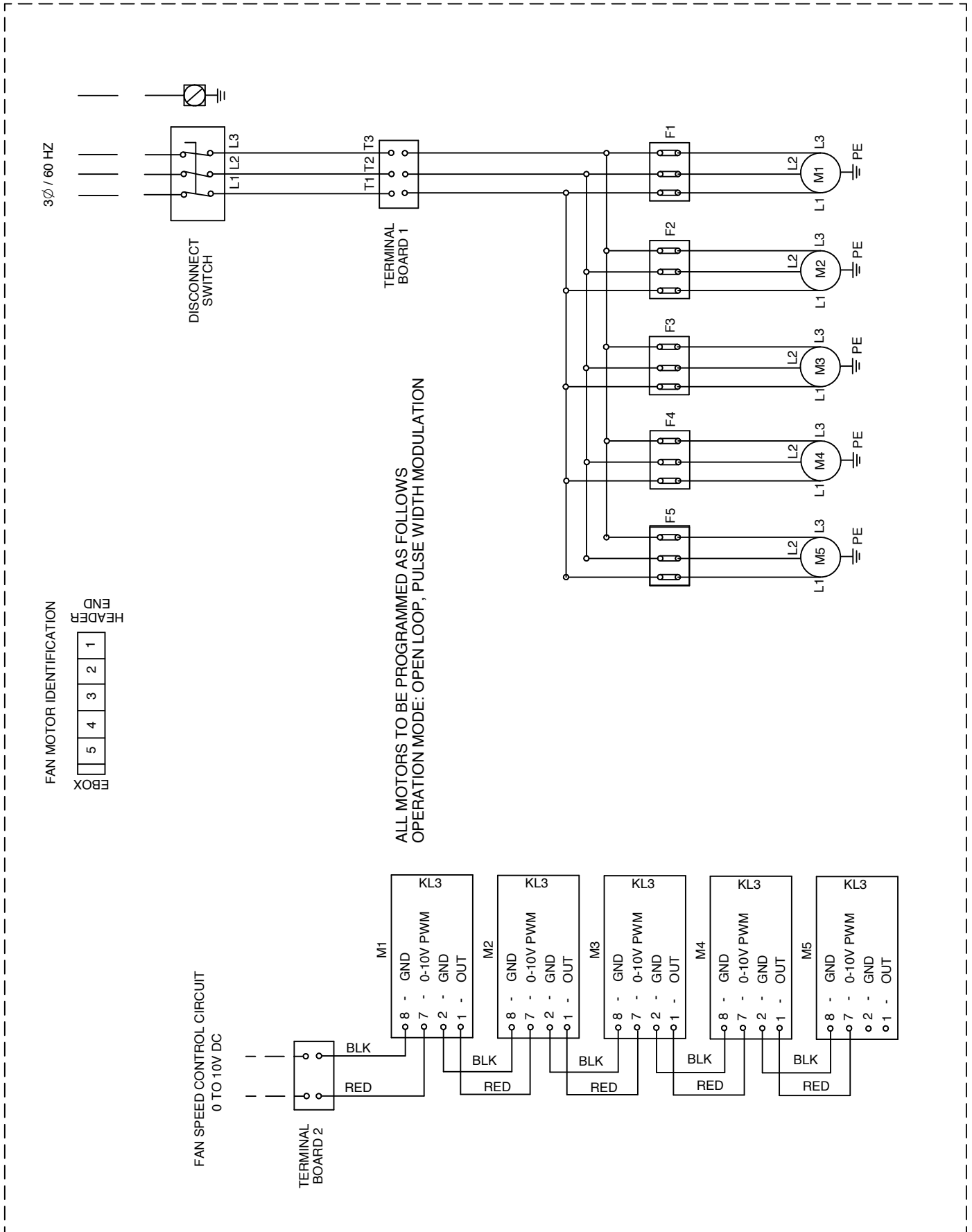

**NOTES:**



2175 West Park Place Blvd.

Stone Mountain, GA 30087

Phone: 800.537.7775 · Fax: 770.465.5900

[heatcrafttrpd.com](http://heatcrafttrpd.com)

Since product improvement is a continuing effort, we reserve the right to make changes in specifications without notice.

**CH-NTC-0121 | Version 002**

©2021 Heatcraft Refrigeration Products LLC