



Slim Contour Unit Cooler
with Modular Cassette Design
ULA/ULE Models



ULA/ULE - Slim Contour Unit Cooler

Maximized Storage, Minimized Energy

The Slim Contour, an innovative unit cooler with a space-saving design, offers enhanced serviceability and maximum cooling performance for food service and food retail markets.

The Slim Contour unit cooler is ideal for applications where maximizing storage capacity in a walk-in cooler or freezer is critical, without sacrificing performance. At less than 11 inches in height, this unit cooler has a 30% reduction in unit height compared to traditional unit coolers in the market today.

The unit comes standard with energy efficient EC (Electronically Commutated) motors, and can be paired with the Heatcraft Beacon II™ Refrigeration System for additional energy efficiency and performance gains.

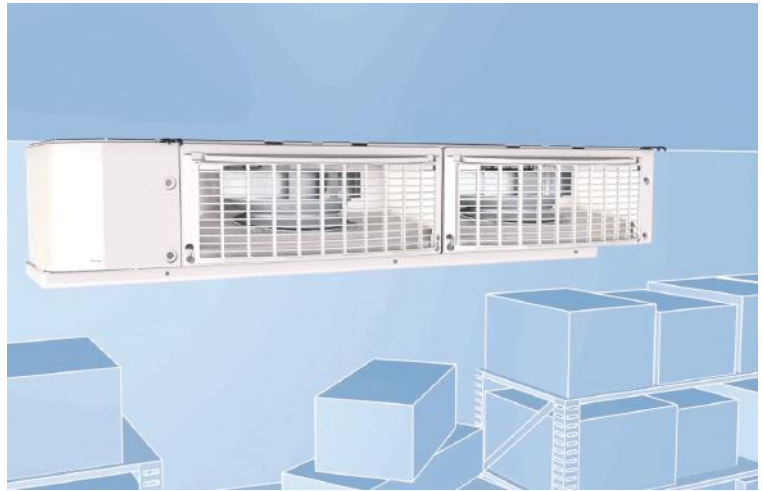

Application

- Air Defrost/medium temperature walk-in cooler
- Electric Defrost/low temperature walk-in freezer

Coil

- Refrigerant optimized small diameter coil pattern

Air Mover

- Energy efficient EC motors standard
- Backward curved centrifugal fan for optimal air flow and more uniform temperatures

Cabinet

- Hybrid design of metal and a ABS resin

Factory Mounted Options

- Heatcraft Beacon II™ Refrigeration System
- Quick Response Controller
- Mounted Thermostat
- Mounted Solenoid Valve
- Mounted Thermostatic Expansion Valve (TXV)



MODULAR CASSETTE DESIGN

Reduced Profile for Added Walk-In Storage

30% Slimmer Unit Height

- Slimmer unit height allows for improved storage space

Reduced Drain Line Height

Angled Drain Line Design

- Minimal drain line height increases product storage
- Reduced drain line damage

Ease of Service

Removable, Modular Fan Cassettes

- Allows for easy access to all components for cleaning
- Serviceable outside of walk-in in a warmer environment

Removable Fan Guard

- Easily removed, attached with two screws
- Made from durable polymer that is dishwasher safe

Mechanical and Electrical Access on Same Side

- Allows for easier unit service

Energy Efficiency & Sustainability

Energy Efficient Motors

- EC Motors come standard on all models

Optimized Coil for Reduced Refrigerant Charge

- Up to a 40% reduction in refrigerant charge

Heatcraft Unit Cooler Portfolio



Low Profile

The industry standard for walk-in cooler applications.

Offering the broadest capacity range, from 4,000 to 37,000 BTUH, the low profile unit cooler is designed for maximum air flow and cooling capacity inside a walk-in cooler.

- Optimized for air and electric defrost applications, the Slim Contour unit cooler is ideally suited for installations where storage space is critical and a higher pull down capability is desired.



Slim Contour



Center Mount

- Available in air or electric defrost, the Center Mount unit is ideal for tight storage situations due to its height of less than 9".
- The center mount design provides a moderated, evenly distributed air flow throughout the box.

More Space Where You Need It Most



THE CHALLENGE

Traditional unit coolers take up valuable space within a walk-in cooler. The drain line also extends another 6" beneath the unit; making it prone to damage and further reducing storage space.

- Servicing the unit is also a challenge as the coil and drain pan cannot be easily accessed for cleaning.

THE SOLUTION

- The Slim Contour unit cooler is optimized for applications where space, performance, and serviceability cannot be compromised.
- The slim 11" height, coupled with modular, removable fan cassettes and a rear swept drain maximize storage space while improving serviceability.

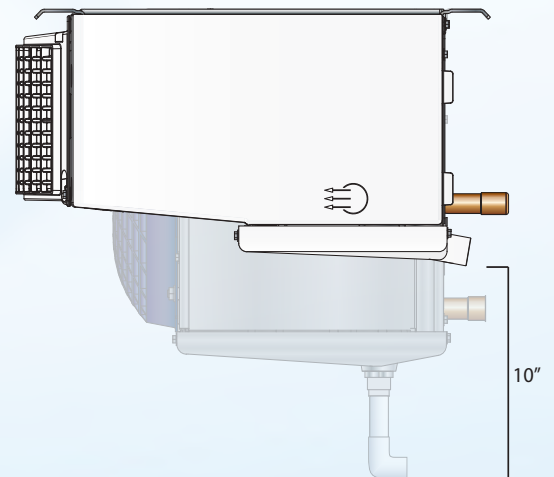

The Most Serviceable Unit Cooler Available

The Slim Contour units are a hybrid design, made from high strength polymer ABS resin and metal, while fans are modular and are easily removed to fully expose the coil and drain pan for easy cleaning.



Modular, removable air mover cassette

- Allows for easy access to components for thorough cleaning
- Modular cassettes allow for service in warmer environments



Removable fan guards

- Fan guards are easily removed and easily cleaned
- Made from durable polymer that is dishwasher safe



Mechanical and electrical service access on same side

- Allows for easier, faster service and installation with access to all critical electrical and mechanical components on one side

Improved Air Coverage Over Traditional Unit Coolers

Traditional Unit Cooler

Slim Contour Unit Cooler

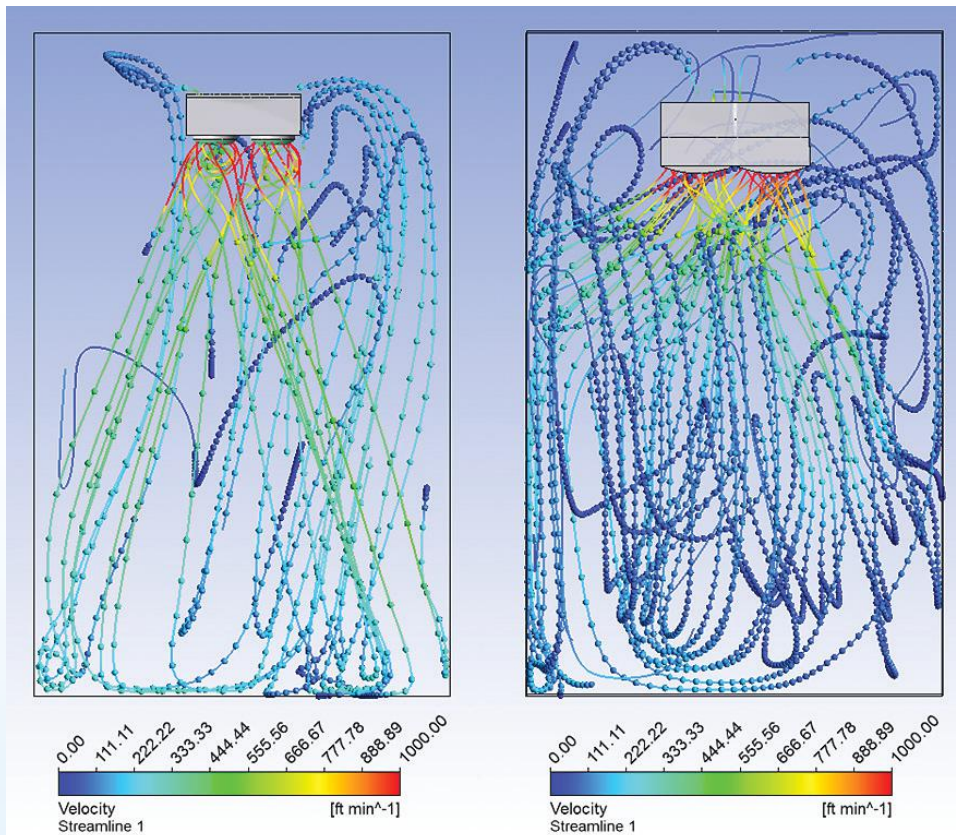

The Slim Contour unit cooler circulates air using a centrifugal fan design, allowing air to circulate at higher velocities for more uniform temperatures in foodservice walk-in coolers and freezers.

Exceptional Cooling Performance

The Slim Contour features a capacity range that mirrors that of the existing unit coolers in the Heatcraft unit cooler portfolio.

Capacity Comparison - Air Defrost Models

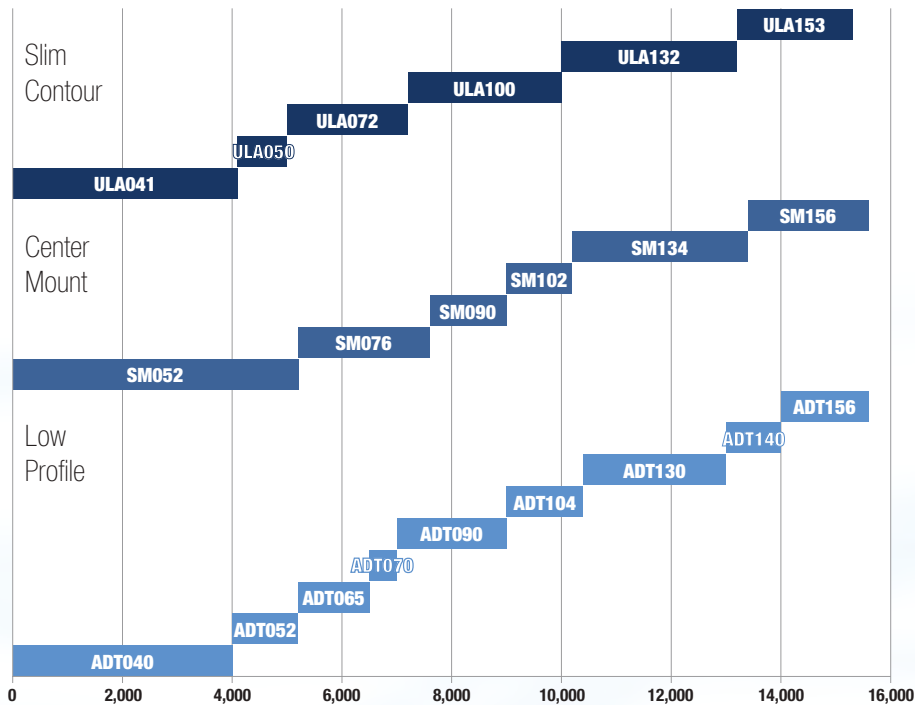

Only 1-3 Fan units shown. Center Mount Available in 1-5 Fans & Low Profile Available in 1-6 fan models.

Capacity Comparison - Electric Defrost Models

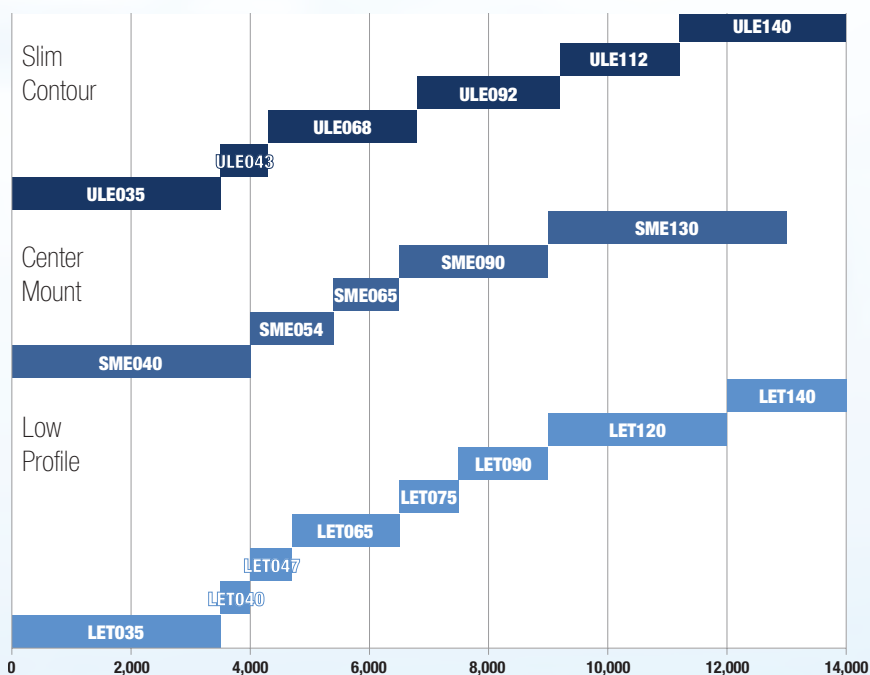

Only 1-3 Fan units shown. Center Mount Available in 1-5 Fans & Low Profile Available in 1-6 fan models.

Nomenclature

| UL | A | 041 | A | E | A |
|-------------------|---|-----------------------|--|--------------|---------|
| Model Series | Defrost Type | Capacity | Electrical Code | Motor Code | Vintage |
| UL = Slim Contour | A = Air Defrost E = Electric Defrost | # BTUH x 100 (R-404A) | A = 115v/1/60Hz B = 208-230v/1/60Hz | E = EC Motor | |

Performance Data

Model ULA - Air Defrost | 50 Hz* / 60 Hz

| Model | Capacity | | | | Fan Data | | |
|--------|----------------------|---------------------|---------------------------|---------------------|----------|-------|------------------|
| | R-404A | | R-407A/C/F, R-448A/R-449A | | No. | CFM | m ³ H |
| | 10°F TD -20°F SST | 6°C TD -29°C SST | 10°F TD -20°F SST | 6°C TD -29°C SST | | | |
| | BTUH | Watts | BTUH | Watts | | | |
| ULA041 | 4,100 | 1,200 | 4,700 | 1,380 | 1 | 530 | 900 |
| ULA050 | 5,000 | 1,460 | 5,800 | 1,700 | 1 | 530 | 900 |
| ULA072 | 7,200 | 2,110 | 8,200 | 2,400 | 2 | 1,090 | 1,852 |
| ULA100 | 10,000 | 2,930 | 11,600 | 3,400 | 2 | 1,090 | 1,852 |
| ULA132 | 13,200 | 3,870 | 15,300 | 4,490 | 3 | 1,675 | 2,846 |
| ULA153 | 15,300 | 4,480 | 17,700 | 5,200 | 3 | 1,675 | 2,846 |

*For EC motors, use 60 Hz capacity and airflow values (Units with EC motors operating at 50 Hz will not see a reduction in performance due to the electronic control of the motor)

Model ULE - Electric Defrost | 60 Hz

| Model | Capacity | | | | Fan Data | | |
|--------|----------------------|---------------------|---------------------------|---------------------|----------|-------|------------------|
| | R-404A | | R-407A/C/F, R-448A/R-449A | | No. | CFM | m ³ H |
| | 10°F TD -20°F SST | 6°C TD -29°C SST | 10°F TD -20°F SST | 6°C TD -29°C SST | | | |
| | BTUH | Watts | BTUH | Watts | | | |
| ULE035 | 3,500 | 1,030 | 3,900 | 1,130 | 1 | 530 | 900 |
| ULE043 | 4,300 | 1,260 | 4,800 | 1,410 | 1 | 530 | 900 |
| ULE068 | 6,800 | 1,990 | 7,800 | 2,270 | 2 | 1,090 | 1,852 |
| ULE092 | 9,200 | 2,700 | 10,300 | 3,020 | 2 | 1,090 | 1,852 |
| ULE112 | 11,200 | 3,280 | 12,800 | 3,740 | 3 | 1,675 | 2,846 |
| ULE140 | 14,000 | 4,100 | 16,000 | 4,680 | 3 | 1,675 | 2,846 |

Capacity Correction Factors - Electric Defrost

| Standard Suction Temperature °F | Multiply Capacity By |
|---------------------------------|----------------------|
| 20 | 1.15 |
| -10 | 1.04 |
| -20 | 1.00 |

Specifications

| Model | HP | EC Motors | | | | Defrost Heaters | |
|--------|------|-----------|-------|--------------|-------|-----------------|-------|
| | | 115/1/60 | | 208-230/1/60 | | 208-230/1/60 | |
| | | Amps | Watts | Amps | Watts | Amps | Watts |
| ULA041 | 1/15 | 1.2 | 72 | 0.6 | 72 | - | - |
| ULA050 | 1/15 | 1.2 | 72 | 0.6 | 72 | - | - |
| ULA072 | 1/15 | 2.4 | 144 | 1.2 | 144 | - | - |
| ULA100 | 1/15 | 2.4 | 144 | 1.2 | 144 | - | - |
| ULA132 | 1/15 | 3.6 | 216 | 1.8 | 216 | - | - |
| ULA153 | 1/15 | 3.6 | 216 | 1.8 | 216 | - | - |
| ULE035 | 1/15 | - | - | 0.6 | 72 | 3.5 | 800 |
| ULE043 | 1/15 | - | - | 0.6 | 72 | 3.5 | 800 |
| ULE068 | 1/15 | - | - | 1.2 | 144 | 6.3 | 1450 |
| ULE092 | 1/15 | - | - | 1.2 | 144 | 6.3 | 1450 |
| ULE112 | 1/15 | - | - | 1.8 | 216 | 9.4 | 2150 |
| ULE140 | 1/15 | - | - | 1.8 | 216 | 9.4 | 2150 |

Physical Data

| Model | No. of Fans | Coil Data | | | Condensate Drain (NPS) | Defrost Type | Approx. Weight (lbs) |
|--------|-------------|-----------|-----------------|------------------|------------------------|--------------|----------------------|
| | | FPI | Coil Inlet (OD) | Coil Outlet (OD) | | | NET |
| ULA041 | 1 | 7 | 1/2" | 5/8" | 3/4" | Air | 36 |
| ULA050 | 1 | 7 | 1/2" | 7/8" | 3/4" | Air | 40 |
| ULA072 | 2 | 7 | 1/2" | 7/8" | 3/4" | Air | 64 |
| ULA100 | 2 | 7 | 1/2" | 7/8" | 3/4" | Air | 68 |
| ULA132 | 3 | 7 | 1/2" | 7/8" | 3/4" | Air | 93 |
| ULA153 | 3 | 7 | 1/2" | 7/8" | 3/4" | Air | 98 |
| ULE035 | 1 | 7 | 1/2" | 5/8" | 3/4" | Electric | 40 |
| ULE043 | 1 | 7 | 1/2" | 7/8" | 3/4" | Electric | 44 |
| ULE068 | 2 | 7 | 1/2" | 7/8" | 3/4" | Electric | 68 |
| ULE092 | 2 | 7 | 1/2" | 7/8" | 3/4" | Electric | 72 |
| ULE112 | 3 | 7 | 1/2" | 7/8" | 3/4" | Electric | 98 |
| ULE140 | 3 | 7 | 1/2" | 7/8" | 3/4" | Electric | 102 |

Replacement Parts

Right source. Right parts. Right now.

InterLink™ Commercial Refrigeration Parts by Heatcraft Worldwide Refrigeration is your link to a complete line of dependable and certified commercial refrigeration parts, accessories and innovative electronic controls for all Heatcraft equipment. With InterLink, we provide our wholesalers with a comprehensive selection of product solutions and innovative technologies for the installed customer base. And every product is built to ensure the same high performance standards with which all Heatcraft Worldwide Refrigeration brands are built — backed by a dedicated team to serve every customer need, delivering at the best lead times in the industry.

Dependable. Versatile. Courteous.

Finally, one simple source for all your replacement needs from a brand you can trust.

For parts, please contact (800) 686-7278 or visit heatcraftprd.com



Replacement Parts

| Part Number | Description |
|-------------------|--------------------------|
| Drain Pans | |
| 55563501 | Drain Pan - 1 Fan |
| 55563601 | Drain Pan - 2 Fan |
| 55563701 | Drain Pan - 3 Fan |
| Heaters | |
| 24799801 | Coil Heater - 1 Fan |
| 24799802 | Coil Heater - 2 Fan |
| 24799803 | Coil Heater - 3 Fan |
| 24799901 | Drain Pan Heater - 1 Fan |
| 24799902 | Drain Pan Heater - 2 Fan |
| 24799903 | Drain Pan Heater - 3 Fan |

| Part Number | Description |
|-------------------------------|---------------------------|
| Motor/Motor Assemblies | |
| 25322001 | 115v Motor |
| 25322101 | 208/230v Motor |
| 89956801 | Motor Cassette - 115v |
| 89956802 | Motor Cassette - 208/230v |
| 22919301 | Motor Blower |
| Panels | |
| 89956301 | Non-Service End Panel |
| 89955501 | Service End Panel |
| 37001101 | Fan Guard |

Nozzle Selections

| | | | | | | | |
|--------|------|----|---|---------|---------|---------|-------|
| ULA041 | 5/32 | 10 | 3 | L-1/4 | L-1/4 | L-1/2 | L-1/4 |
| ULA050 | 5/32 | 10 | 4 | L-1/3 | L-1/3 | L-1/2 | L-1/4 |
| ULA072 | 5/32 | 10 | 4 | L-1/2 | L-1/2 | L-3/4 | L-1/3 |
| ULA100 | 5/32 | 10 | 8 | L-3/4 | L-3/4 | L-1 | L-1/2 |
| ULA132 | 5/32 | 10 | 6 | L-1 | L-1 | L-1-1/2 | L-3/4 |
| ULA153 | 5/32 | 10 | 8 | L-1 | L-1 | L-1-1/2 | L-3/4 |
| ULE035 | 5/32 | 10 | 3 | L-1/2 | L-1/3 | L-1/2 | L-1/4 |
| ULE043 | 5/32 | 10 | 4 | L-1/2 | L-1/2 | L-3/4 | L-1/3 |
| ULE068 | 5/32 | 10 | 4 | L-3/4 | L-3/4 | L-1 | L-1/2 |
| ULE092 | 5/32 | 10 | 8 | L-1 | L-1 | L-1-1/2 | L-3/4 |
| ULE112 | 5/32 | 10 | 6 | L-1-1/2 | L-1-1/2 | L-2 | L-3/4 |
| ULE140 | 5/32 | 10 | 8 | L-1-1/2 | L-1-1/2 | L-2 | L-1 |

NOTE:

Nozzles sized for 90-100°F liquid temperature at expansion valve.

Contact Application Engineering for guidance if

- Liquid temperature is not 90-100°F
- Evaporator TD is not 10°-15°F (room temperature – saturated suction temperature)
- Electric defrost and hot gas models with a saturated suction temperature of 10°F or higher

Caution: Refrigeration system will not perform properly without correct nozzle!

*R-22 Nozzles for informational purposes only. Not included with stocking evaporators

Dimensional Information

Dimensions - Non-Model Specific

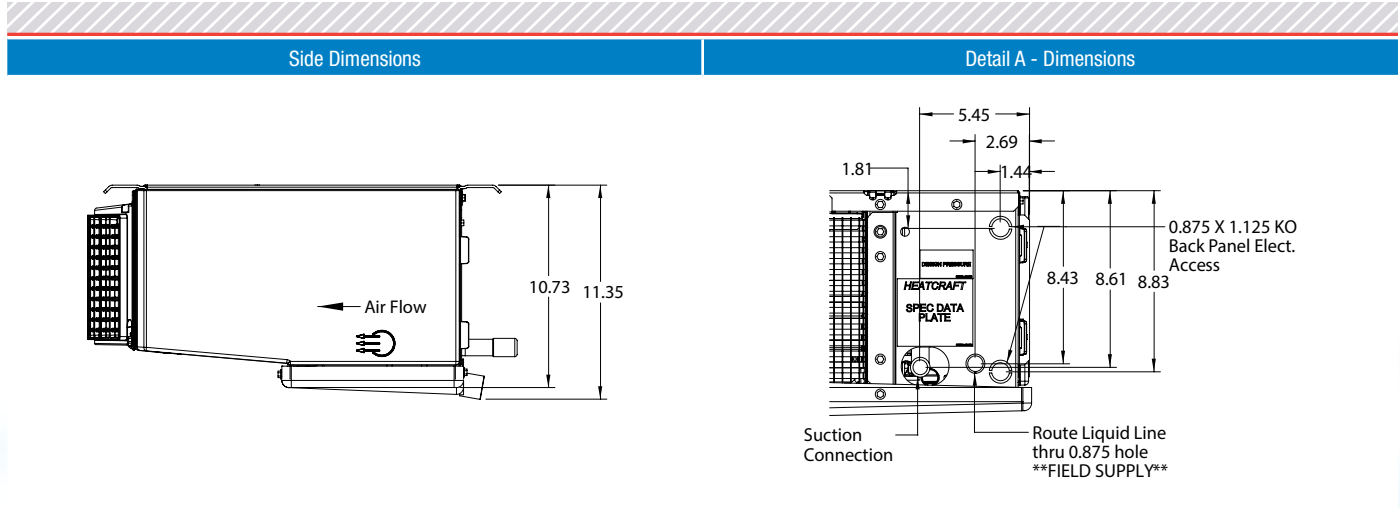

Dimensions - Model Specific

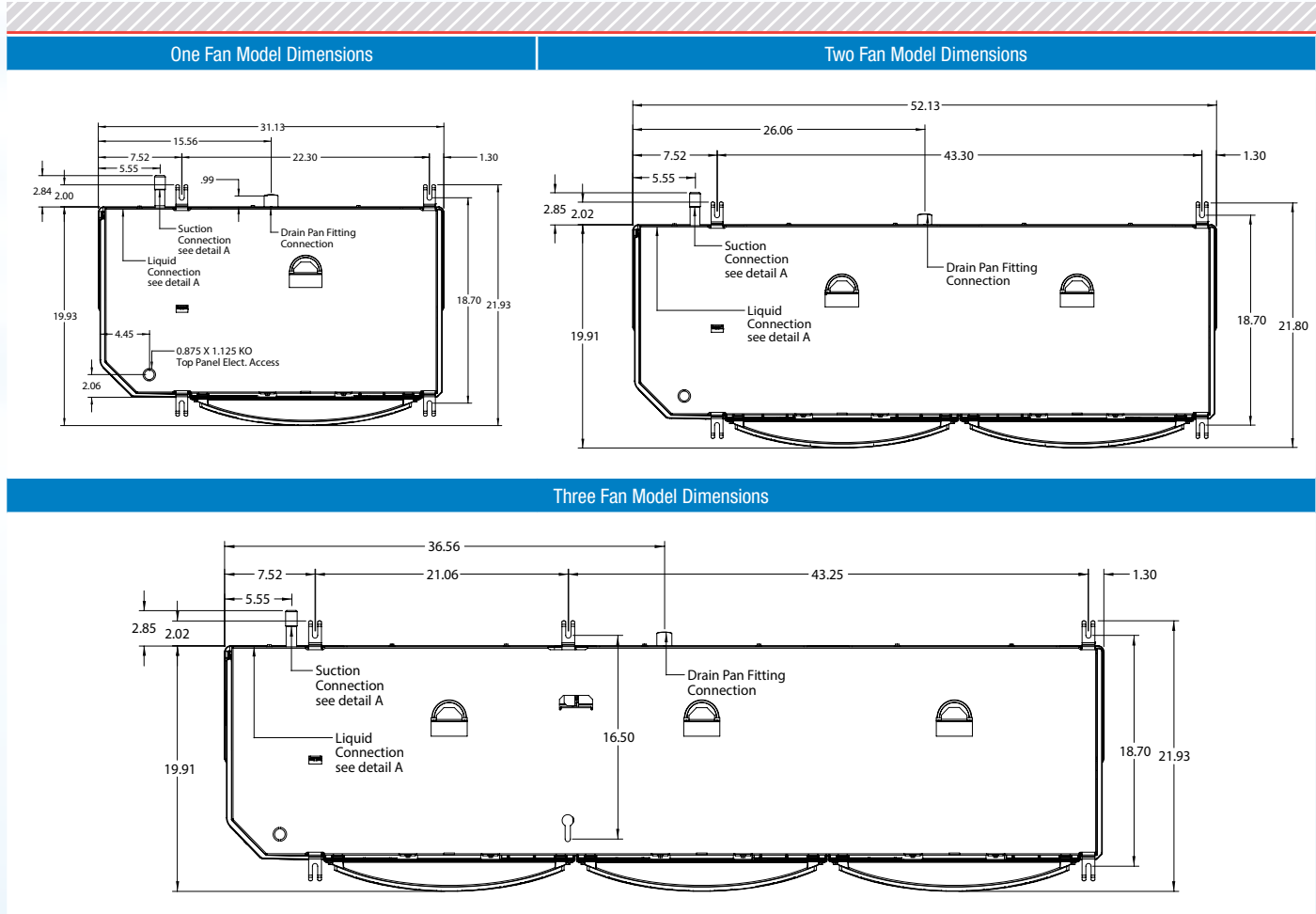



2175 West Park Place Blvd. · Stone Mountain, GA 30087
Phone: 800.537.7775 · Fax: 770.465.5900
heatcraftprd.com



CLIMATE

CONTROL

Since product improvement is a continuing effort, we reserve the right to make changes in specifications without notice.

CC-SLIM-0418 | Version 000