



Price List

LK-PL - February 2024





TABLE OF CONTENTS

SECTION 1

REACH-IN UNIT COOLERS

Thin Profile Air Defrost	3
Thin Profile Electric Defrost	4
C Profile	5
V Profile	6
Back Bar	7
Mullion	8
Reverse Mullion	9
Twin Flow	10
Dual Air	11

WALK-IN UNIT COOLERS

Low Profile	13
Low Velocity Center Mount	36
Center Mount	47
Medium Profile	58

REFRIGERATED WAREHOUSE UNIT COOLERS

Large Unit Coolers	81
--------------------	----

CO₂ UNIT COOLERS

CO ₂ DX Low Profile	130
CO ₂ DX Low Velocity Center Mount	144
CO ₂ DX Center Mount	149

GLYCOL UNIT COOLERS

Glycol Low Profile	171
Glycol Low Velocity Center Mount	182
Glycol Center Mount	185
Glycol Medium Profile	187

SECTION 2

COMPRESSORIZED PRODUCTS

Air-Cooled Condensing Units	
▪ 1/2 - 6 HP Air Cooled Condensing Units	192
▪ 3 - 22 HP Air Cooled Condensing Units	204
▪ 12 - 50 HP Verical Air Cooled Condensing Units	217
▪ 24 - 100 HP Dual Verical Air Cooled Condensing Units	229
Water-Cooled Condensing Units	
▪ 1/2 - 6 HP Water Cooled Condensing Units	243
▪ 3/4 - 22 HP Water Cooled Condensing Units	249

Remote Compressor Units

▪ 3/4 - 22 HP Remote Compressor Units	254
---------------------------------------	-----

Packaged System

▪ PRO ³ Packaged Refrigeration Systems	260
---	-----

SECTION 3

CONDENSERS & FLUID COOLERS

1 - 26 Ton Air Cooled Condensers	265
11 - 264 Ton Air Cooled Condensers	269
NTC Gas Cooler	286
FN Fluid Coolers	292
Small Fluid Coolers	306

SECTION 4

REFRIGERATION CONTROLS & TECHNOLOGY

intelliGen™ Refrigeration Controller	309
Universal Field-Mount Refrigeration Controller	310
Multi-system with Lead Lag (MSC)	311
Retrofit Kits for Beacon II and QRC Controls	312
Shipped Loose or Service Parts	313
HyperCore™ Microchannel Coils	310
Remote Refrigeration Control	311
Lead Lag Temperature Controller	312

OTHER PRODUCTS & SERVICES

Air-Cooled Package Chiller	313
Screw Compressor Condensing Units	314
Commercial Financing	315
Mohave™ Advanced Hot Gas Defrost System	316
Two-Stage Condensing Units & Systems	317
FlexPack™	318
Air Handlers	319
Refrigeration Racks	320
Compressor Protection Plan	321
Extended Service Agreement	322

SECTION 5

Terms of Sale & Product Warranty	323
----------------------------------	-----



REACH-IN UNIT COOLERS

Thin Profile Air Defrost

Model TA is a thin profile air defrost unit which mounts in the top of a refrigerator and makes the entire top shelf area usable. The attractive low silhouette makes the unit particularly desirable for display type refrigerators. It can also be used in back bars, under counter cabinets, or wherever space is at a premium and is ideal for 35° to 45°F fixtures at 10° to 15° TD applications with 16 hours maximum compressor run time per day.

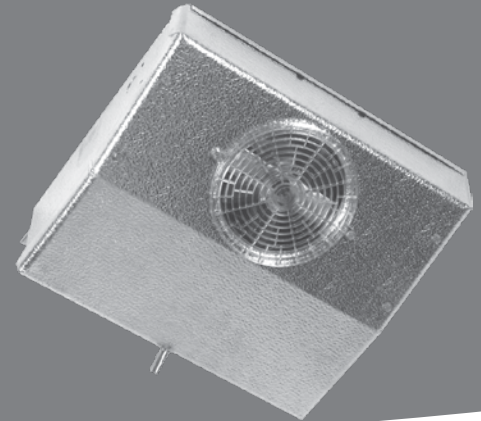

NOMENCLATURE



TA	K	17	B	G
Model Series	Coil Option	Model Size	Electrical Code	Vintage
Thin Profile Air Defrost	Blank = Standard K = Coated	# x 100 = BTUH	A = 115/1/60 B = 208-230/1/60	

OVERVIEW

STANDARD FEATURES

- Textured aluminum cabinet
- Molded Polycarbonate guards and fans
- Drain fitting mounted at 45° angle so drain can be run through back or bottom of refrigerator
- Expansion valve can be mounted inside the cabinet
- Stainless steel screws
- Motors are thermally protected and permanently lubricated
- Convenient, moisture proof motor plug

- Compact design achieves a big job in a small space
- Internal junction box for electrical connection
- Sweat inlet connection standard to reduce leaks

OPTIONS

- Flare connection available as a ship loose option
- Optional coated coil available (Model TAK) for enhanced protection in corrosive environments

MODEL PRICING

Larkin Standard Model	Voltage	List Price (\$US)	Larkin Standard Model	Voltage	List Price (\$US)	Larkin Standard Model	Voltage	List Price (\$US)
TA10AG	115/1/60	1058	TA43AG	115/1/60	3,413	TAK23AG	115/1/60	2,266
TA10BG	208-230/1/60	1136	TA43BG	208-230/1/60	3,650	TAK23BG	208-230/1/60	2,424
TA13AG	115/1/60	1368	TA55AG	115/1/60	4,326	TAK30AG	115/1/60	2,766
TA13BG	208-230/1/60	1467	TA55BG	208-230/1/60	4,626	TAK30BG	208-230/1/60	2,957
TA17AG	115/1/60	1599	TAK10AG	115/1/60	1,234	TAK43AG	115/1/60	3,749
TA17BG	208-230/1/60	1706	TAK10BG	208-230/1/60	1,323	TAK43BG	208-230/1/60	4,017
TA23AG	115/1/60	2031	TAK13AG	115/1/60	1,570	TAK55AG	115/1/60	4,809
TA23BG	208-230/1/60	2183	TAK13BG	208-230/1/60	1,685	TAK55BG	208-230/1/60	5,151
TA30AG	115/1/60	2526	TAK17AG	115/1/60	1,788			
TA30BG	208-230/1/60	2698	TAK17BG	208-230/1/60	1,916			



REACH-IN UNIT COOLERS

Thin Profile Electric Defrost

Model TL low temperature unit cooler has a completely automatic defrost system. Mounted in the top of a refrigerator, its extremely compact cabinet makes it possible to utilize the entire top shelf area for storage. Having a normal operating range of +20°F. to -20°F., this unit is ideally suited applications including commercial freezers, ice cream boxes, bakery freezers and dual-temp reach-in boxes. Mechanical contact is provided between the heater elements and the drain pan, ensuring a warm pan during the defrost cycle.

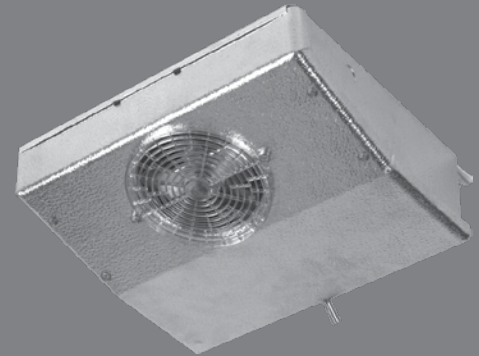

NOMENCLATURE



TL	12	B	G
Model Series	Model Size	Electrical Code	Vintage
Thin Profile Electric Defrost	# x 100 = BTUH	A = 115/1/60 B = 208-230/1/60	

OVERVIEW

STANDARD FEATURES

- Electric defrost ensures positive heat source
- Built-in fan delay allows coil to be chilled before returning to the normal cooling cycle
- Defrost terminates on coil temperature eliminating excessive defrost period
- Textured aluminum cabinet
- Molded Polycarbonate guard
- Knockouts provided on sides for electrical connections - opening in rear for coil connections
- Expansion valve can be mounted inside the cabinet
- Stainless steel screws

- Motors are thermally protected and permanently lubricated
- Internal junction box for electrical connection
- Plate type aluminum fins with full collars on expanded copper tubes
- Coils are dehydrated and sealed
- Easy to install and maintain
- Sweat inlet connection to reduce leaks
- All models UL listed for the US and Canada
- UL classified to NSF standards Dimensional Data

OPTIONS

- Flare connection available as a ship loose option
- EC motors available for some models

MODEL PRICING

Larkin Standard Model	Voltage	List Price (\$US)
TL09AG	115/1/60	1,763
TL09BG	208-230/1/60	1,763
TL12AG	115/1/60	2,121
TL12BG	208-230/1/60	2,121
TL16AG	115/1/60	2,622
TL16BG	208-230/1/60	2,622

Larkin Standard Model	Voltage	List Price (\$US)
TL21AG	115/1/60	2,980
TL21BG	208-230/1/60	2,980
TL28AG	115/1/60	3,749
TL28BG	208-230/1/60	3,749
TL35BG	208-230/1/60	4,231
TL53BG	208-230/1/60	5,824



REACH-IN UNIT COOLERS

C Profile

Model C is ideal for refrigerated reach-ins. It mounts to the top of the refrigerator and discharges cold air against the back wall. With this air flow pattern, the air is not blasted on the product but is diffused along the back wall and then gently drawn across the product as it returns to the unit. Thus, uniform temperatures are maintained throughout the refrigerator. In addition, door sweating and refrigeration loss due to door opening is greatly reduced because the air is not discharged against the doors. Mounting is made easy by means of aluminum hangers that automatically space the unit the correct distance from the back wall. The expansion valve fits inside, out of sight.

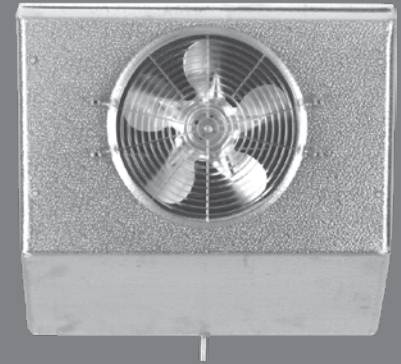

NOMENCLATURE



C	K	43	B	G
Model Series	Coil Option	Model Size	Electrical Code	Vintage
High Profile Unit Cooler	Blank = Standard K = Coated	# x 100 = BTUH	A = 115/1/60 B = 208-230/1/60	

OVERVIEW

STANDARD FEATURES

- Textured aluminum cabinet
- Molded Polycarbonate guard
- Drain fitting at 45-degree angle so drain can be run through bottom or back of refrigerator
- Aluminum hangers automatically space the unit to the correct distance from the back wall
- Stainless steel screws prevent rust streaks
- Room for expansion valve inside the unit
- Knockouts in sides and top plus openings in rear provide maximum flexibility for electrical connection
- Full collar aluminum fins on expanded copper tubes

- Internal junction box with pigtail leads for electrical connection
- Motors are thermally protected and permanently lubricated
- Sweat inlet connection standard to reduce leaks
- All models UL listed for US and Canada
- UL classified to NSF standards

OPTIONS

- Flare connection available as a ship loose option
- Optional coated coil available (Model CK) for enhanced protection in corrosive environments
- EC motors available

MODEL PRICING

Larkin Standard Model	Voltage	List Price (\$US)
C13AG	115/1/60	1352
C13BG	208-230/1/60	1451
C17AG	115/1/60	1428
C17BG	208-230/1/60	1536
C23AG	115/1/60	1664
C23BG	208-230/1/60	1787
C30AG	115/1/60	2143
C30BG	208-230/1/60	2380
C43AG	115/1/60	2680
C43BG	208-230/1/60	2870

Larkin Standard Model	Voltage	List Price (\$US)
CK13AG	115/1/60	1451
CK13BG	208-230/1/60	1556
CK17AG	115/1/60	1552
CK17BG	208-230/1/60	1658
CK23AG	115/1/60	1788
CK23BG	208-230/1/60	1916
CK30AG	115/1/60	2474
CK30BG	208-230/1/60	2638
CK43AG	115/1/60	3189
CK43BG	208-230/1/60	3420



REACH-IN UNIT COOLERS

V Profile

Model VA is a deluxe unit designed for use in small reach-ins, back bar and under counter refrigerators, and many other applications where a small, compact unit is required. The thermal expansion valve mounts inside the unit. The unit can be mounted from the ceiling or off the back wall or end walls, or can be used in a mullion application.

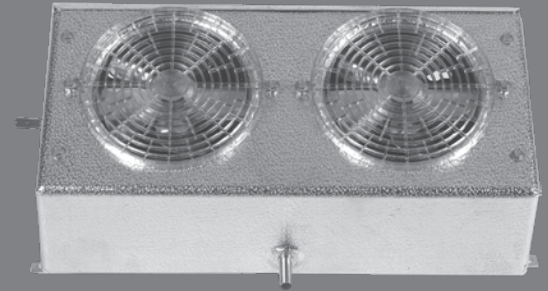

NOMENCLATURE



V	K	08	A	G
Model Series	Coil Option	Model Size	Electrical Code	Vintage
V Profile Unit Cooler	Blank = Standard K = Coated	# x 100 = BTUH	A = 115/1/60 B = 208-230/1/60	

OVERVIEW

STANDARD FEATURES

- Textured aluminum cabinet
- Molded Polycarbonate fan guard
- Improved drain pan overlaps coil surface to catch all condensate
- Stainless steel screws prevent rust streaks
- Plate-type aluminum fins with full collars on expanded copper tubes
- Expansion valve can be mounted inside the cabinet
- Internal junction box for electrical connection
- Pigtail leads in junction box
- Motors are thermally protected and permanently lubricated

- Top quality throughout in a compact size
- Sweat inlet connection standard to reduce leaks
- All models UL listed for US and Canada
- UL classified to NSF standards

OPTIONS

- Flare connection available as a ship loose option
- Optional coated coil available (Model VAK) for enhanced protection in corrosive environments
- EC motors available for some models

MODEL PRICING

Larkin Standard Model	Voltage	List Price (\$US)
VA06AG	115/1/60	889
VA06BG	208-230/1/60	954
VA08AG	115/1/60	954
VA08BG	208-230/1/60	1026
VA12AG	115/1/60	1298
VA12BG	208-230/1/60	1392
VA17AG	115/1/60	1467
VA17BG	208-230/1/60	1565

Larkin Standard Model	Voltage	List Price (\$US)
VAK06AG	115/1/60	1027
VAK06BG	208-230/1/60	1094
VAK08AG	115/1/60	1087
VAK08BG	208-230/1/60	1162
VAK12AG	115/1/60	1402
VAK12BG	208-230/1/60	1502
VAK17AG	115/1/60	1570
VAK17BG	208-230/1/60	1685



REACH-IN UNIT COOLERS

Back Bar

Model BB, available in medium and low temperature, a compact, wall-mounted units featuring a low height making them ideal for under counter reach-in or drawertype fixtures. The unit draws air in at the bottom and discharges out the front. An optional air deflector is included and can be mounted over the center of the fan to direct air up and out. The deflector can be fieldformed to direct the air where needed, usually onto drop-in trays of condiments in salad bar or sandwich preparation fixtures. An S-type mounting angle is included to position the unit 3/4" off the wall, allowing for optimum air circulation and performance.

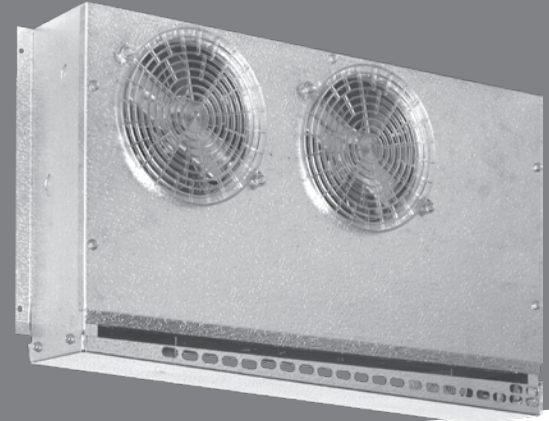

NOMENCLATURE



BB	L	S	10	B	G
Model Series	Coil Option	Unit Type	Model Size	Electrical Code	Vintage
Back Bar Unit Cooler	L = Low M = Medium	Blank = Standard S = Slave M = Master	# x 100 - BTUH	A = 115/1/60 B = 208-230/1/60	

OVERVIEW

STANDARD FEATURES

- Molded Polycarbonate fan guards
- Coils have copper tubes with aluminum fins, mechanically bonded for efficient heat transfer. The coils are dehydrated and sealed
- Textured aluminum cabinet
- Knockouts are conveniently located for refrigerant lines
- Screws are hardened, stainless steel
- Expansion valve can be mounted inside the cabinet and connections are sweat-type
- Motors are thermally protected and permanently lubricated
- Master units include the basic unit plus factory mounted expansion valve,

solenoid, and temperature control. Also right-hand piping extended 8"-12" outside the housing, sealed and pressurized to 20 - 30 PSI. A 1/4" OD liquid feed to slave is included

- Slave units include the basic unit plus factory mounted expansion valve with left-hand piping extended 8" - 12" outside the housing, sealed and pressurized to 20 - 30 PSI
- Sweat inlet connection to reduce leaks

OPTIONS

- Flare connection available as a ship loose option
- Consult Factory for 208-230V units

MODEL PRICING

Larkin Standard Model	Voltage	List Price (\$US)
BBM11AG	115/1/60	1,847
BBM16AG	115/1/60	2,228
BBMM11AG	115/1/60	4,065
BBMM16AG	115/1/60	4,455
BBMS11AG	115/1/60	3,531
BBMS16AG	115/1/60	3,921

Larkin Standard Model	Voltage	List Price (\$US)
BBL10AG	115/1/60	2,488
BBL15AG	115/1/60	2,956
BBLM10AG	115/1/60	5,370
BBLM15AG	115/1/60	5,996
BBLS10AG	115/1/60	4,835
BBLS15AG	115/1/60	5,460



REACH-IN UNIT COOLERS

Mullion

Product Description

Model KMK is ideal for under-counter reachin refrigerators. The thin line design allows the unit to be mounted behind the mullion with sufficient clearance for tray slides. A down flow fan arrangement is used with air drawn in at the top and discharged at the bottom. This design provides superior air circulation and ensures uniform temperature throughout the cabinet. This versatile design is also adaptable for mounting on the back wall or ends of a cooler. The method of air circulation ensures minimum box temperature rise when the cabinet doors are open. Ideal for bottled goods and beverage coolers.

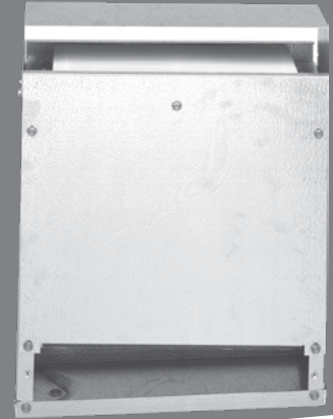

NOMENCLATURE



KM	K	13	A	G
Model Series	Coil Option	Model Size	Electrical Code	Vintage
Kompact Mullion	K = Coated	# x 100 = BTUH	A = 115/1/60 B = 208-230/1/60	

OVERVIEW

STANDARD FEATURES

- Light grained aluminum cabinets
- PVC coated fan guard
- Stainless steel hardware
- Coils have full collar aluminum fins on expanded copper tubes
- Coated coil for enhanced protection in corrosive environments
- Refrigerant connection knockouts provided on both ends of unit
- Expansion valve can be mounted inside the cabinet
- Motors are thermally protected and permanently lubricated

- Internal junction box for electrical connection
- Adjustable air deflector included provides different air patterns. Air can be directed where it's needed
- Sweat inlet connection to reduce leaks
- All models UL listed for the US and Canada
- UL classified to NSF standards

OPTIONS

- Flare connection available as a ship loose option

MODEL PRICING

Larkin Standard Model	Voltage	List Price (\$US)
KMK13AG	115/1/60	1,944
KMK13BG	208-230/1/60	2,078
KMK17AG	115/1/60	2,354
KMK17BG	208-230/1/60	2,511
KMK23AG	115/1/60	2,814
KMK23BG	208-230/1/60	3,010



REACH-IN UNIT COOLERS

Reverse Mullion

Product Description

Model RAMK is ideal for under-counter reach-in refrigerators, under-counter drawer type refrigerators and salad bars. The unit is suitable for mounting behind a mullion or on a wall. An up flow air pattern is used with air drawn in at the bottom and discharged out the top. This provides optimum temperature for drop in trays on salad bars or prep tables. It also keeps drawer stored product in premium condition. An adjustable and detachable air deflector/splash protector is included. The deflector can be adjusted to direct the air up and out at a 45° angle. This feature provides excellent air distribution over drop in trays or containers. Food in the trays and containers stays colder, lasts longer, and retains the desired appearance. The deflector can be adjusted to distribute air out both sides when used as a mullion unit.

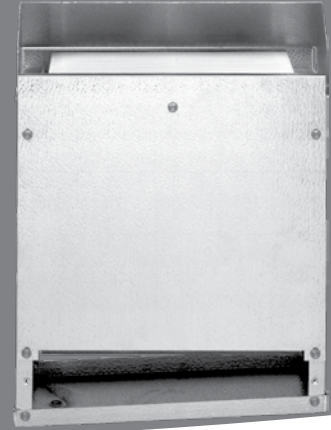

NOMENCLATURE



RAM	K	13	A	G
Model Series	Coil Option	Model Size	Electrical Code	Vintage
Revere Air Flow Kompact Mullion	K = Coated	# x 100 = BTUH	A = 115/1/60 B = 208-230/1/60	

OVERVIEW

STANDARD FEATURES

- Textured aluminum cabinet
- PVC coated fan guard
- Stainless steel hardware
- Coils have full collar aluminum fins on expanded copper tubes
- Coated coil for enhanced protection in corrosive environments
- Refrigerant connection knockouts provided on both ends of unit
- Expansion valve can be mounted inside the cabinet
- Motors are thermally protected and permanently lubricated

- Internal junction box for electrical connection
- Adjustable air deflector included provides different air patterns. Air can be directed where it's needed
- Sweat inlet connection standard to reduce leaks
- All models are UL listed for the US and Canada
- UL classified to NSF standards

OPTIONS

- Flare connection available as a ship loose option

MODEL PRICING

Larkin Standard Model	Voltage	List Price (\$US)
RAMK13AG	115/1/60	1,944
RAMK13BG	208-230/1/60	2,078
RAMK17AG	115/1/60	2,354
RAMK17BG	208-230/1/60	2,511
RAMK23AG	115/1/60	2,814
RAMK23BG	208-230/1/60	3,010



REACH-IN UNIT COOLERS

Twin Flow

Product Description

Model BTO is a compact two-way design with medium velocity airflow. The unit is mounted flush to the ceiling and draws air in through the fan and discharges out both sides. The air pattern reduces air loss when doors are opened and the medium velocity reduces product drying. Twin flow units are for temperatures of 35°F. and higher. Box temperatures are kept more constant throughout and fresh products last longer. Seven sizes are available with BTUH from 900 to 5500 at 10° TD.



NOMENCLATURE



BTO	K	33	A	G
Model Series	Coil Option	Model Size	Electrical Code	Vintage
Twin Flow Unit Cooler	Blank = Standard K = Coated	# x 100 = BTUH	A = 115/1/60 B = 208-230/1/60	

OVERVIEW

STANDARD FEATURES

- Compact two-way design with medium velocity air flow
- Mounts flush to the ceiling and draws air in through the fan and discharges out both sides
- Air pattern reduces air loss when doors are opened and the medium velocity reduces product drying
- Textured aluminum cabinet
- Stainless steel fasteners
- Molded Polycarbonate fan guards
- Drain pan and fan panel is easily removed for installation and servicing
- Coils are constructed of copper tubing with aluminum fins
- Expansion valve can be mounted inside the cabinet

- Internal junction box is provided for electrical connection
- Motors are thermally protected and permanently lubricated
- Sweat inlet connection to reduce leaks
- All models are UL listed for the US and Canada
- UL classified to NSF standards

OPTIONS

- Flare connection available as a ship loose option
- Optional coated coil available (Model BTOK) for enhanced protection in corrosive environments
- EC motors available for some models

MODEL PRICING

Larkin Standard Model	Voltage	List Price (\$US)
BTO09AG	115/1/60	1110
BTO09BG	208-230/1/60	1193
BTO13AG	115/1/60	1469
BTO13BG	208-230/1/60	1567
BTO18AG	115/1/60	1704
BTO18BG	208-230/1/60	1820
BTO25AG	115/1/60	2096
BTO25BG	208-230/1/60	2231
BTO35AG	115/1/60	2716
BTO35BG	208-230/1/60	2904
BTO45AG	115/1/60	3438
BTO45BG	208-230/1/60	3678
BTO55AG	115/1/60	4366
BTO55BG	208-230/1/60	4675
BTOK09AG	115/1/60	1315

Larkin Standard Model	Voltage	List Price (\$US)
BTOK09BG	208-230/1/60	1416
BTOK13AG	115/1/60	1578
BTOK13BG	208-230/1/60	1688
BTOK18AG	115/1/60	2003
BTOK18BG	208-230/1/60	2143
BTOK25AG	115/1/60	2467
BTOK25BG	208-230/1/60	2632
BTOK35AG	115/1/60	3198
BTOK35BG	208-230/1/60	3423
BTOK45AG	115/1/60	4002
BTOK45BG	208-230/1/60	4283
BTOK55AG	115/1/60	4974
BTOK55BG	208-230/1/60	5324



REACH-IN UNIT COOLERS

Dual Air

Product Description

Model U unit cooler is used wherever a small, compact unit is required, such as salad boxes, back bars and direct draw boxes. It can be mounted on the ceiling or wall. The Model U unit draws air in through the front and discharges it out both sides to ensure proper distribution of cool air and thus maintain a uniform box temperature.

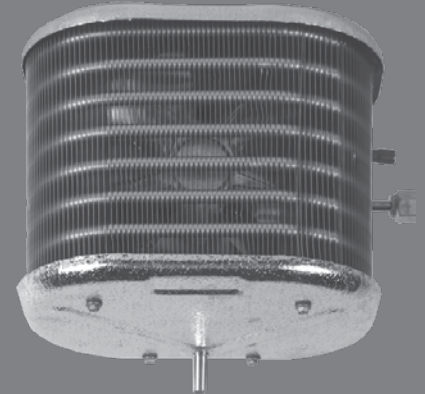

NOMENCLATURE



U	K	09	0
Model Series	Coil Option	Model Size	Electrical Code
Dual Air Standard Coil	Blank = Standard K = Coated	# x 100 = BTUH	0 = 115/1/60 1 = 208-230/1/60

OVERVIEW

STANDARD FEATURES

- Textured aluminum cabinet
- Full collar aluminum fins on expanded copper tubes
- Detachable drain pan that is easy to clean
- Molded 3-prong motor connector to save installation time and expense
- Motors are thermally protected and permanently lubricated
- Optional coated coil available (Model UK) for enhanced protection in corrosive environments

- Sweat inlet connection to reduce leaks
- All models are UL recognized for the US and Canada
- UL classified to NSF standards

OPTIONS

- Flare connection available as a ship loose option

MODEL PRICING

Larkin Standard Model	Voltage	List Price (\$US)
U0090	115/1/60	1099
U0091	208-230/1/60	1446
U0120	115/1/60	1249
U0121	208-230/1/60	1565
U0150	115/1/60	1400
U0151	208-230/1/60	1733
UK0090	115/1/60	1259
UK0091	208-230/1/60	1645
UK0120	115/1/60	1422
UK0121	208-230/1/60	1810
UK0150	115/1/60	1599
UK0151	208-230/1/60	1961



REACH-IN UNIT COOLERS

Shipped-Loose Accessories

Can't Find Something or need help selecting the appropriate accessory for your unit? Please contact your local Sales Representative or Account Engineer for assistance.

Part Number	Description	List Price (\$US)	Notes
Room Thermostats			
2891040	Room Thermostat	490	-
28963301	Electronic Room Thermostat	798	-
Defrost Controls			
4267W	Adjustable Defrost Control / Fan Delay Switch	483	-

EXPANSION VALVES (TXV)

When placing order, please specify refrigerant type, saturated suction temperature (SST), liquid temperature, and room temperature.

Part Number	List Price (\$US)	Capacity Range (BTUH)
TXV024	571	24,000 BTUH and under

LIQUID-LINE SOLENOID VALVES (LLSV)

Part Number	List Price (\$US)	Size	Capacity Range (R-404A)	
			Medium Temperature Application (BTUH)	Low Temperature Application (BTUH)
29318013	589	3/8	12,000 BTUH and under	11,000 BTUH and under

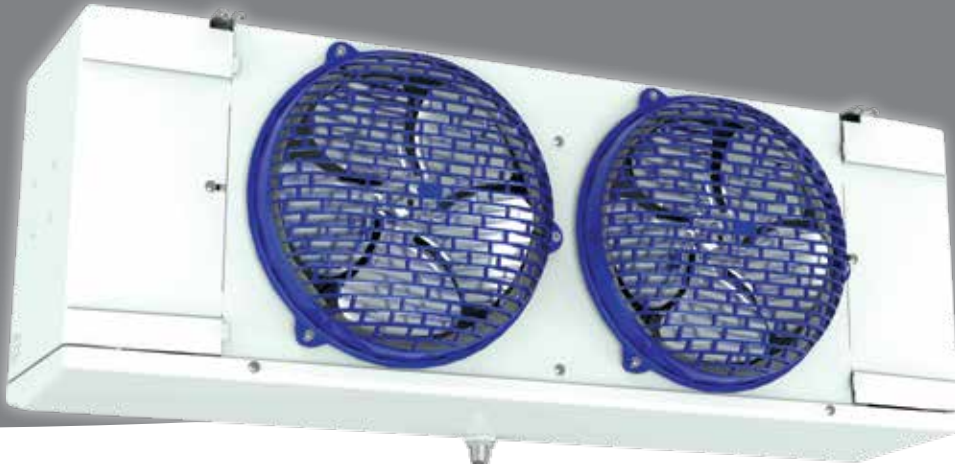

LOW PROFILE EVAPORATOR

NOMENCLATURE

REFRIGERANT DESIGNATOR

S = Standard Refrigerants (R-404A, R-448A/R-449A, R-407A/R-407F, R-407C)
G = Glycol
C = CO₂

DEFROST STYLE

A = Air Defrost
E = Electric Defrost
H = Hot Gas Defrost

PRODUCT IDENTIFIER

E = Evaporator

NOMINAL CAPACITY

x100 = BTU/h

DESIGN REVISION

L E L 0095 A S 6 A M A B0000

BRAND

L = Larkin

EVAPORATOR STYLE

L = Low Profile

ELECTRICAL CODE

A = 115/1/60
B = 208-230/1/60
C = 208-230/3/60
M = 460/1/60

FINS PER INCH (FPI)

MOTOR TYPE

M = 2-Speed EC
E = Single Speed EC
C = PSC Totally Enclosed

FACTORY-INSTALLED OPTION PACKAGES

B#### = Preferred Option Packages
D#### = A la Carte Options
Y#### = Custom Option Packages

FEATURES & BENEFITS

EASE OF INSTALLATION & SERVICE

- Cabinet design features hinged, removable front access panels on each side for easy access to electrical and refrigeration components.
- All electrical components factory-wired to terminal board and identified, making it easy to field wire the unit.
- Liquid line solenoid wire harness is factory-installed for quick installation.
- Pre-drilled holes on the back of the unit for room thermostat.
- Coil heater slots have been enlarged for easier installation and replacement.
- Hinged, removable drain pan allows for easy and safe access.
- Motors plug into wiring harness for easier servicing.
- Hot gas loop on bottom of coil for easier access is standard on hot gas defrost models.

VERSATILE

- Large diameter drain hole (3/4" ID) is located towards the back of the unit.
- Minimal height of the low profile series makes it ideal for low ceiling coolers

RELIABLE & DURABLE

- Heavy gauge grained aluminum cabinet cleans easily and looks attractive.
- Molded fan guard and access panels are made of strong, durable, NSF and UL Sanitation rated lightweight and damage resistant plastic material.
- Sweat connections to reduce potential for leaks.

PERFORMANCE

- Internal panels are isolated for quiet operation.
- Internally enhanced tubing and fin design for higher efficiency.
- Optimized heater placement with reduced heater wattages.
- Fixed defrost termination for electric, adjustable defrost termination for hot gas.
- Extended drain pan heaters for more uniform defrost throughout the drain pan and additional heat in end compartments.

OUTSTANDING FEATURES

Optional Factory Mounted Components

Choose from Heatcraft's industry-leading IntelliGen™ Refrigeration Controller or traditional mechanical components.

Composite Molded Access Panels have undergone extensive engineering and laboratory testing to ensure they are damage resistant from drops, dents, and bangs.

Hinged & Removeable Access Panels allow for easy access to both refrigeration and electrical end of Low Profile units.



Hinged Drain Pan improves access to service and clean the drain pan and coil.

Easy Service Motor Mount quickly and easily allows motor to be removed for service or replacement.

Re-Engineered Fan Guards have been redesigned for optimized air circulation and comply to new UL60335 safety standard.



PREFERRED OPTION PACKAGES

Heatcraft now offers pre-defined kits that represent frequently ordered options or combinations of options. The preferred kits make it easier for customers to configure their units and may provide a savings over factory installed a la carte option selections.

Bundle options and save!

5% discount on bundled options selected over same A la Carte Options

Refer to page 25 for A la carte options.

Preferred Options	Package Description
B0000	Standard Base
B0200	intelliGen™ Refrigeration Control (R-404A/R-448A/R-449A)
B0201	intelliGen™ Refrigeration Control (R-407A/C/F)
B0403	Mounted Components (TXV, Solenoid Valve, Elec. T'Stat - R-404A)
B0404	Mounted Components (TXV, Solenoid Valve, Elec. T'Stat - R-407A/C/F)
B0405	Mounted Components (TXV, Solenoid Valve, Elec. T'Stat - R-448A/R-449A)

Example:

BASE MODEL 4,500 BTU Air Defrost (BEL0045AS6AMAB0000) \$2,999	+	B0403 (Standard base + Mounted TXV (404A) + Liquid Solenoid valve + Elec. Room T'stat) = \$1,831	=	\$4,830
		TXV & LLSV	+	Elec. T'Stat
		\$1,926		\$4,926



AIR DEFROST PREFERRED MODELS

Please consult AWEF and Net Capacity table of Technical bulletin on page 43 to confirm DOE compliance per model

Air Defrost Preferred Models with 2 Speed EC Motors - 115/1/60

Base Model	List Price (\$US)					
	B0000	B0200	B0201	B0403	B0404	B0405
LEL0045AS6AMA	3,089	6,298	6,298	4,975	4,975	4,975
LEL0055AS6AMA	3,297	6,506	6,506	5,183	5,183	5,183
LEL0060AS6AMA	3,510	6,719	6,719	5,396	5,396	5,396
LEL0095AS6AMA	5,052	8,261	8,261	6,938	6,938	6,938
LEL0105AS6AMA	5,351	8,560	8,560	7,237	7,237	7,237
LEL0115AS6AMA	5,687	8,896	8,896	7,573	7,573	7,573
LEL0125AS6AMA	6,042	9,251	9,251	7,928	7,928	7,928
LEL0155AS6AMA	7,630	10,839	10,839	9,516	9,516	9,516
LEL0190AS6AMA	8,541	11,750	11,750	10,427	10,427	10,427
LEL0250AS6AMA	9,928	13,137	13,137	11,814	11,814	11,814
LEL0295AS6AMA	12,357	15,566	15,566	14,243	14,243	14,243
LEL0350AS6AMA	14,225	17,434	17,434	16,778	16,778	16,778
LEL0380AS6AMA	16,028	19,237	19,237	18,581	18,581	18,581

Air Defrost Preferred Models with 2 Speed EC Motors - 208-230/1/60

Base Model	List Price (\$US)					
	B0000	B0200	B0201	B0403	B0404	B0405
LEL0045BS6AMA	3,127	6,336	6,336	5,013	5,013	5,013
LEL0055BS6AMA	3,429	6,638	6,638	5,315	5,315	5,315
LEL0060BS6AMA	3,732	6,941	6,941	5,618	5,618	5,618
LEL0095BS6AMA	5,113	8,322	8,322	6,999	6,999	6,999
LEL0105BS6AMA	5,418	8,627	8,627	7,304	7,304	7,304
LEL0115BS6AMA	5,752	8,961	8,961	7,638	7,638	7,638
LEL0125BS6AMA	6,108	9,317	9,317	7,994	7,994	7,994
LEL0155BS6AMA	7,724	10,933	10,933	9,610	9,610	9,610
LEL0190BS6AMA	8,627	11,836	11,836	10,513	10,513	10,513
LEL0250BS6AMA	10,526	13,735	13,735	12,412	12,412	12,412
LEL0295BS6AMA	13,104	16,313	16,313	14,990	14,990	14,990
LEL0350BS6AMA	15,073	18,282	18,282	17,626	17,626	17,626
LEL0380BS6AMA	16,808	20,017	20,017	19,361	19,361	19,361



AIR DEFROST PREFERRED MODELS

Please consult AWEF and Net Capacity table of Technical bulletin on page 43 to confirm DOE compliance per model

Air Defrost Preferred Models with EC Motors - 115/1/60

Base Model	List Price (\$US)					
	B0000	B0200	B0201	B0403	B0404	B0405
LEL0045AS6AEA	3,001	6,210	6,210	4,887	4,887	4,887
LEL0055AS6AEA	3,207	6,416	6,416	5,093	5,093	5,093
LEL0060AS6AEA	3,411	6,620	6,620	5,297	5,297	5,297
LEL0095AS6AEA	4,911	8,120	8,120	6,797	6,797	6,797
LEL0105AS6AEA	5,203	8,412	8,412	7,089	7,089	7,089
LEL0115AS6AEA	5,528	8,737	8,737	7,414	7,414	7,414
LEL0125AS6AEA	5,872	9,081	9,081	7,758	7,758	7,758
LEL0155AS6AEA	7,489	10,698	10,698	9,375	9,375	9,375
LEL0190AS6AEA	8,380	11,589	11,589	10,266	10,266	10,266
LEL0250AS6AEA	9,742	12,951	12,951	11,628	11,628	11,628
LEL0295AS6AEA	12,127	15,336	15,336	14,013	14,013	14,013
LEL0350AS6AEA	13,964	17,173	17,173	16,517	16,517	16,517
LEL0380AS6AEA	15,731	18,940	18,940	18,284	18,284	18,284

Air Defrost Preferred Models with EC Motors - 208-230/1/60

Base Model	List Price (\$US)					
	B0000	B0200	B0201	B0403	B0404	B0405
LEL0045BS6AEA	3,040	6,249	6,249	4,926	4,926	4,926
LEL0055BS6AEA	3,333	6,542	6,542	5,219	5,219	5,219
LEL0060BS6AEA	3,628	6,837	6,837	5,514	5,514	5,514
LEL0095BS6AEA	4,972	8,181	8,181	6,858	6,858	6,858
LEL0105BS6AEA	5,265	8,474	8,474	7,151	7,151	7,151
LEL0115BS6AEA	5,590	8,799	8,799	7,476	7,476	7,476
LEL0125BS6AEA	5,938	9,147	9,147	7,824	7,824	7,824
LEL0155BS6AEA	7,583	10,792	10,792	9,469	9,469	9,469
LEL0190BS6AEA	8,471	11,680	11,680	10,357	10,357	10,357
LEL0250BS6AEA	10,330	13,539	13,539	12,216	12,216	12,216
LEL0295BS6AEA	12,861	16,070	16,070	14,747	14,747	14,747
LEL0350BS6AEA	14,793	18,002	18,002	17,346	17,346	17,346
LEL0380BS6AEA	16,499	19,708	19,708	19,052	19,052	19,052



AIR DEFROST PREFERRED MODELS

Please consult AWEF and Net Capacity table of Technical bulletin on page 43 to confirm DOE compliance per model

Air Defrost Preferred Models with PSC Motors - 115/1/60

Base Model	List Price (\$US)					
	B0000	B0200	B0201	B0403	B0404	B0405
LEL0045AS6ACA	2,408	5,617	5,617	4,294	4,294	4,294
LEL0055AS6ACA	2,614	5,823	5,823	4,500	4,500	4,500
LEL0060AS6ACA	2,819	6,028	6,028	4,705	4,705	4,705
LEL0095AS6ACA	3,726	6,935	6,935	5,612	5,612	5,612
LEL0105AS6ACA	4,019	7,228	7,228	5,905	5,905	5,905
LEL0115AS6ACA	4,342	7,551	7,551	6,228	6,228	6,228
LEL0125AS6ACA	4,688	7,897	7,897	6,574	6,574	6,574
LEL0155AS6ACA	5,714	8,923	8,923	7,600	7,600	7,600
LEL0190AS6ACA	6,605	9,814	9,814	8,491	8,491	8,491
LEL0250AS6ACA	7,376	10,585	10,585	9,262	9,262	9,262
LEL0295AS6ACA	9,168	12,377	12,377	11,054	11,054	11,054
LEL0350AS6ACA	10,409	13,618	13,618	12,962	12,962	12,962
LEL0380AS6ACA	12,180	15,389	15,389	14,733	14,733	14,733

Air Defrost Preferred Models with PSC Motors - 208-230/1/60

Base Model	List Price (\$US)					
	B0000	B0200	B0201	B0403	B0404	B0405
LEL0045BS6ACA	2,449	5,658	5,658	4,335	4,335	4,335
LEL0055BS6ACA	2,742	5,951	5,951	4,628	4,628	4,628
LEL0060BS6ACA	3,035	6,244	6,244	4,921	4,921	4,921
LEL0095BS6ACA	3,788	6,997	6,997	5,674	5,674	5,674
LEL0105BS6ACA	4,083	7,292	7,292	5,969	5,969	5,969
LEL0115BS6ACA	4,406	7,615	7,615	6,292	6,292	6,292
LEL0125BS6ACA	4,752	7,961	7,961	6,638	6,638	6,638
LEL0155BS6ACA	5,806	9,015	9,015	7,692	7,692	7,692
LEL0190BS6ACA	6,693	9,902	9,902	8,579	8,579	8,579
LEL0250BS6ACA	7,963	11,172	11,172	9,849	9,849	9,849
LEL0295BS6ACA	9,898	13,107	13,107	11,784	11,784	11,784
LEL0350BS6ACA	11,241	14,450	14,450	13,794	13,794	13,794
LEL0380BS6ACA	12,946	16,155	16,155	15,499	15,499	15,499



AIR DEFROST PREFERRED MODELS

Please consult AWEF and Net Capacity table of Technical bulletin on page 43 to confirm DOE compliance per model

Air Defrost Preferred Models with PSC Motors - 460/1/60

Base Model	List Price (\$US)					
	B0000	B0200	B0201	B0403	B0404	B0405
LEL0045MS6ACA	2,739	-	-	4,625	4,625	4,625
LEL0055MS6ACA	3,033	-	-	4,919	4,919	4,919
LEL0060MS6ACA	3,327	-	-	5,213	5,213	5,213
LEL0095MS6ACA	4,378	-	-	6,264	6,264	6,264
LEL0105MS6ACA	4,668	-	-	6,554	6,554	6,554
LEL0115MS6ACA	4,989	-	-	6,875	6,875	6,875
LEL0125MS6ACA	5,345	-	-	7,231	7,231	7,231
LEL0155MS6ACA	6,687	-	-	8,573	8,573	8,573
LEL0190MS6ACA	7,572	-	-	9,458	9,458	9,458
LEL0250MS6ACA	9,136	-	-	11,022	11,022	11,022
LEL0295MS6ACA	11,363	-	-	13,249	13,249	13,249
LEL0350MS6ACA	13,002	-	-	15,555	15,555	15,555
LEL0380MS6ACA	14,710	-	-	17,263	17,263	17,263



ELECTRIC DEFROST PREFERRED MODELS

Please consult AWEF and Net Capacity table of Technical Bulletin on pages 44 & 45 to confirm DOE compliance per model

Electric Defrost Preferred Models with 2 Speed EC Motors - 208-230/1/60

Base Model	List Price (\$US)					
	B0000	B0200	B0201	B0403	B0404	B0405
LEL0040BS6EMA	4,409	7,618	7,618	6,295	6,295	6,295
LEL0045BS6EMA	4,888	8,097	8,097	6,774	6,774	6,774
LEL0065BS6EMA	5,605	8,814	8,814	7,491	7,491	7,491
LEL0080BS6EMA	6,322	9,531	9,531	8,208	8,208	8,208
LEL0100BS6EMA	6,978	10,187	10,187	8,864	8,864	8,864
LEL0130BS6EMA	8,943	12,152	12,152	10,829	10,829	10,829
LEL0155BS6EMA	10,142	13,351	13,351	12,028	12,028	12,028
LEL0170BS6EMA	11,918	15,127	15,127	13,804	13,804	13,804
LEL0205BS6EMA	13,171	16,380	16,380	15,057	15,057	15,057
LEL0240BS6EMA	15,128	18,337	18,337	17,014	17,014	17,014
LEL0255BS6EMA	17,281	20,490	20,490	19,834	19,834	19,834
LEL0310BS6EMA	19,378	22,587	22,587	21,931	21,931	21,931
LEL0045BS4EMA	4,061	7,270	7,270	5,947	5,947	5,947
LEL0070BS4EMA	6,836	10,045	10,045	8,722	8,722	8,722
LEL0090BS4EMA	7,338	10,547	10,547	9,224	9,224	9,224
LEL0135BS4EMA	8,867	12,076	12,076	10,753	10,753	10,753
LEL0180BS4EMA	11,728	14,937	14,937	13,614	13,614	13,614
LEL0220BS4EMA	14,817	18,026	18,026	16,703	16,703	16,703
LEL0275BS4EMA	19,051	22,260	22,260	21,604	21,604	21,604

Electric Defrost Preferred Models with 2-Speed EC Motors - 208-230/3/60

Base Model	List Price (\$US)					
	B0000	B0200	B0201	B0403	B0404	B0405
LEL0040CS6EMA	4,535	-	-	6,421	6,421	6,421
LEL0045CS6EMA	5,163	-	-	7,049	7,049	7,049
LEL0065CS6EMA	5,980	-	-	7,866	7,866	7,866
LEL0080CS6EMA	6,795	-	-	8,681	8,681	8,681
LEL0100CS6EMA	7,454	-	-	9,340	9,340	9,340
LEL0130CS6EMA	9,413	-	-	11,299	11,299	11,299
LEL0155CS6EMA	10,650	-	-	12,536	12,536	12,536
LEL0170CS6EMA	12,383	-	-	14,269	14,269	14,269
LEL0205CS6EMA	13,783	-	-	15,669	15,669	15,669
LEL0240CS6EMA	15,598	-	-	17,484	17,484	17,484
LEL0255CS6EMA	17,751	-	-	20,304	20,304	20,304
LEL0310CS6EMA	20,098	-	-	22,651	22,651	22,651
LEL0045CS4EMA	4,268	-	-	6,154	6,154	6,154
LEL0070CS4EMA	7,117	-	-	9,003	9,003	9,003
LEL0090CS4EMA	7,543	-	-	9,429	9,429	9,429
LEL0135CS4EMA	9,334	-	-	11,220	11,220	11,220
LEL0180CS4EMA	12,206	-	-	14,092	14,092	14,092
LEL0220CS4EMA	15,286	-	-	17,172	17,172	17,172
LEL0275CS4EMA	19,647	-	-	22,200	22,200	22,200



ELECTRIC DEFROST PREFERRED MODELS

Please consult AWEF and Net Capacity table of Technical Bulletin on pages 44 & 45 to confirm DOE compliance per model

Electric Defrost Preferred Models with EC Motors - 208-230/1/60

Base Model	List Price (\$US)					
	B0000	B0200	B0201	B0403	B0404	B0405
LEL0040BS6EEA	4,284	7,493	7,493	6,170	6,170	6,170
LEL0045BS6EEA	4,750	7,959	7,959	6,636	6,636	6,636
LEL0065BS6EEA	5,448	8,657	8,657	7,334	7,334	7,334
LEL0080BS6EEA	6,147	9,356	9,356	8,033	8,033	8,033
LEL0100BS6EEA	6,783	9,992	9,992	8,669	8,669	8,669
LEL0130BS6EEA	8,778	11,987	11,987	10,664	10,664	10,664
LEL0155BS6EEA	9,957	13,166	13,166	11,843	11,843	11,843
LEL0170BS6EEA	11,697	14,906	14,906	13,583	13,583	13,583
LEL0205BS6EEA	12,927	16,136	16,136	14,813	14,813	14,813
LEL0240BS6EEA	14,847	18,056	18,056	16,733	16,733	16,733
LEL0255BS6EEA	16,959	20,168	20,168	19,512	19,512	19,512
LEL0310BS6EEA	19,021	22,230	22,230	21,574	21,574	21,574
LEL0045BS4EEA	3,947	7,156	7,156	5,833	5,833	5,833
LEL0070BS4EEA	6,648	9,857	9,857	8,534	8,534	8,534
LEL0090BS4EEA	7,132	10,341	10,341	9,018	9,018	9,018
LEL0135BS4EEA	8,700	11,909	11,909	10,586	10,586	10,586
LEL0180BS4EEA	11,508	14,717	14,717	13,394	13,394	13,394
LEL0220BS4EEA	14,542	17,751	17,751	16,428	16,428	16,428
LEL0275BS4EEA	18,697	21,906	21,906	21,250	21,250	21,250

Electric Defrost Preferred Models with EC Motors - 208-230/3/60

Base Model	List Price (\$US)					
	B0000	B0200	B0201	B0403	B0404	B0405
LEL0040CS6EEA	4,408	-	-	6,294	6,294	6,294
LEL0045CS6EEA	5,021	-	-	6,907	6,907	6,907
LEL0065CS6EEA	5,810	-	-	7,696	7,696	7,696
LEL0080CS6EEA	6,605	-	-	8,491	8,491	8,491
LEL0100CS6EEA	7,247	-	-	9,133	9,133	9,133
LEL0130CS6EEA	9,237	-	-	11,123	11,123	11,123
LEL0155CS6EEA	10,453	-	-	12,339	12,339	12,339
LEL0170CS6EEA	12,153	-	-	14,039	14,039	14,039
LEL0205CS6EEA	13,528	-	-	15,414	15,414	15,414
LEL0240CS6EEA	15,311	-	-	17,197	17,197	17,197
LEL0255CS6EEA	17,421	-	-	19,974	19,974	19,974
LEL0310CS6EEA	19,728	-	-	22,281	22,281	22,281
LEL0045CS4EEA	4,147	-	-	6,033	6,033	6,033
LEL0070CS4EEA	6,916	-	-	8,802	8,802	8,802
LEL0090CS4EEA	7,331	-	-	9,217	9,217	9,217
LEL0135CS4EEA	9,162	-	-	11,048	11,048	11,048
LEL0180CS4EEA	11,980	-	-	13,866	13,866	13,866
LEL0220CS4EEA	15,004	-	-	16,890	16,890	16,890
LEL0275CS4EEA	19,282	-	-	21,835	21,835	21,835



ELECTRIC DEFROST PREFERRED MODELS

Please consult AWEF and Net Capacity table of Technical Bulletin on pages 44 & 45 to confirm DOE compliance per model

Electric Defrost Preferred Models with PSC Motors - 208-230/1/60

Base Model	List Price (\$US)					
	B0000	B0200	B0201	B0403	B0404	B0405
LEL0040BS6ECA	3,692	6,901	6,901	5,578	5,578	5,578
LEL0045BS6ECA	4,159	7,368	7,368	6,045	6,045	6,045
LEL0065BS6ECA	4,560	7,769	7,769	6,446	6,446	6,446
LEL0080BS6ECA	4,962	8,171	8,171	6,848	6,848	6,848
LEL0100BS6ECA	5,599	8,808	8,808	7,485	7,485	7,485
LEL0130BS6ECA	7,003	-	-	8,889	8,889	8,889
LEL0155BS6ECA	8,180	-	-	10,066	10,066	10,066
LEL0170BS6ECA	9,329	-	-	11,215	11,215	11,215
LEL0205BS6ECA	10,559	-	-	12,445	12,445	12,445
LEL0240BS6ECA	11,888	-	-	13,774	13,774	13,774
LEL0255BS6ECA	13,406	-	-	15,959	15,959	15,959
LEL0310BS6ECA	15,471	-	-	18,024	18,024	18,024
LEL0045BS4ECA	3,354	6,563	6,563	5,240	5,240	5,240
LEL0070BS4ECA	5,461	8,670	8,670	7,347	7,347	7,347
LEL0090BS4ECA	5,947	9,156	9,156	7,833	7,833	7,833
LEL0135BS4ECA	6,927	-	-	8,813	8,813	8,813
LEL0180BS4ECA	9,140	-	-	11,026	11,026	11,026
LEL0220BS4ECA	11,582	-	-	13,468	13,468	13,468
LEL0275BS4ECA	15,144	-	-	17,697	17,697	17,697

Electric Defrost Preferred Models with PSC Motors - 208-230/3/60

Base Model	List Price (\$US)					
	B0000	B0200	B0201	B0403	B0404	B0405
LEL0040CS6ECA	3,817	-	-	5,703	5,703	5,703
LEL0045CS6ECA	4,430	-	-	6,316	6,316	6,316
LEL0065CS6ECA	4,924	-	-	6,810	6,810	6,810
LEL0080CS6ECA	5,421	-	-	7,307	7,307	7,307
LEL0100CS6ECA	6,064	-	-	7,950	7,950	7,950
LEL0130CS6ECA	7,463	-	-	9,349	9,349	9,349
LEL0155CS6ECA	8,675	-	-	10,561	10,561	10,561
LEL0170CS6ECA	9,787	-	-	11,673	11,673	11,673
LEL0205CS6ECA	11,160	-	-	13,046	13,046	13,046
LEL0240CS6ECA	12,350	-	-	14,236	14,236	14,236
LEL0255CS6ECA	13,869	-	-	16,422	16,422	16,422
LEL0310CS6ECA	16,174	-	-	18,727	18,727	18,727
LEL0045CS4ECA	3,558	-	-	5,444	5,444	5,444
LEL0070CS4ECA	5,732	-	-	7,618	7,618	7,618
LEL0090CS4ECA	6,149	-	-	8,035	8,035	8,035
LEL0135CS4ECA	7,385	-	-	9,271	9,271	9,271
LEL0180CS4ECA	9,615	-	-	11,501	11,501	11,501
LEL0220CS4ECA	12,044	-	-	13,930	13,930	13,930
LEL0275CS4ECA	15,730	-	-	18,283	18,283	18,283



ELECTRIC DEFROST PREFERRED MODELS

Please consult AWEF and Net Capacity table of Technical Bulletin on pages 44 & 45 to confirm DOE compliance per model

Electric Defrost Preferred Models with PSC Motors - 460/1/60

Base Model	List Price (\$US)					
	B0000	B0200	B0201	B0403	B0404	B0405
LEL0040MS6ECA	4,112	-	-	5,998	5,998	5,998
LEL0045MS6ECA	4,726	-	-	6,612	6,612	6,612
LEL0065MS6ECA	5,366	-	-	7,252	7,252	7,252
LEL0080MS6ECA	6,008	-	-	7,894	7,894	7,894
LEL0100MS6ECA	6,652	-	-	8,538	8,538	8,538
LEL0130MS6ECA	8,342	-	-	10,228	10,228	10,228
LEL0155MS6ECA	9,563	-	-	11,449	11,449	11,449
LEL0170MS6ECA	10,964	-	-	12,850	12,850	12,850
LEL0205MS6ECA	12,331	-	-	14,217	14,217	14,217
LEL0240MS6ECA	13,815	-	-	15,701	15,701	15,701
LEL0255MS6ECA	15,634	-	-	18,187	18,187	18,187
LEL0310MS6ECA	17,932	-	-	20,485	20,485	20,485
LEL0045MS4ECA	3,847	-	-	5,733	5,733	5,733
LEL0070MS4ECA	6,024	-	-	7,910	7,910	7,910
LEL0090MS4ECA	6,442	-	-	8,328	8,328	8,328
LEL0135MS4ECA	8,270	-	-	10,156	10,156	10,156
LEL0180MS4ECA	10,782	-	-	12,668	12,668	12,668
LEL0220MS4ECA	13,514	-	-	15,400	15,400	15,400
LEL0275MS4ECA	17,491	-	-	20,044	20,044	20,044



HOT GAS DEFROST BASE MODELS

Please consult AWEF and Net Capacity table of Technical Bulletin on pages 46 & 47 to confirm DOE compliance per model.

Hot Gas Defrost Base Models

Base Model	List Price (\$US)						
	*A=115/1/60			*B=208-230/1/60			*M=460/1/60
	^M = 2 Speed EC	^E = EC Motor	^C = PSC Motor	^M = 2 Speed EC	^E = EC Motor	^C = PSC Motor	^C = PSC Motor
	B0000	B0000	B0000	B0000	B0000	B0000	B0000
LEL0040*S6H^A	4,358	4,235	3,643	4,463	4,338	3,746	4,141
LEL0045*S6H^A	4,951	4,814	4,222	5,073	4,929	4,337	4,642
LEL0065*S6H^A	5,528	5,372	4,485	5,786	5,623	4,733	5,184
LEL0080*S6H^A	6,105	5,933	4,749	6,499	6,315	5,129	5,729
LEL0100*S6H^A	7,306	7,104	5,918	7,796	7,576	6,391	6,989
LEL0130*S6H^A	8,790	8,627	6,852	9,351	9,179	7,401	8,294
LEL0155*S6H^A	10,230	10,038	8,264	10,601	10,404	8,625	9,519
LEL0170*S6H^A	11,382	11,169	8,800	12,103	11,880	9,508	10,711
LEL0205*S6H^A	12,766	12,529	10,160	13,715	13,463	11,090	12,284
LEL0240*S6H^A	13,711	13,457	10,499	14,571	14,301	11,337	12,829
LEL0255*S6H^A	16,247	15,946	12,396	17,462	17,139	13,578	15,380
LEL0310*S6H^A	18,333	17,994	14,442	19,783	19,418	15,856	17,658
LEL0045*S4H^A	4,234	4,119	3,528	4,342	4,222	3,628	3,858
LEL0070*S4H^A	7,053	6,858	5,671	7,236	7,032	5,846	6,297
LEL0090*S4H^A	7,465	7,255	6,070	7,678	7,463	6,274	6,721
LEL0135*S4H^A	8,631	8,473	6,695	9,188	9,018	7,238	7,913
LEL0180*S4H^A	11,276	11,066	8,697	11,984	11,762	9,386	10,278
LEL0220*S4H^A	13,936	13,679	10,719	14,805	14,529	11,565	12,683
LEL0275*S4H^A	18,369	18,028	14,477	19,608	19,245	15,683	17,022

* = Voltage Code

^ = Motor Code



FACTORY INSTALLED: A LA CARTE OPTION PACKAGES

Refer to page 16 for preferred option packages.

Electrical Options

Larkin Model	Factory Installed: A la Carte Options (List Price Adder US \$)							Notes
	Electrical Options							
	intelliGen™	intelliGen Cards			Mech. Room T'stat	Electronic Room T'stat	Adj. Defrost Term./Fan Delay	
Webserver Card		Multi-System Control (MSC)	Integration Card					
LEL0045*S6A	3,378	1,089	1,500	618	506	783	-	Electrical Control Options intelliGen™, intelliGen Cards, QRC and Beacon II™ are not applicable for 208-230/3/60 and 460/1/60.
LEL0055*S6A	3,378	1,089	1,500	618	506	783	-	
LEL0060*S6A	3,378	1,089	1,500	618	506	783	-	
LEL0095*S6A	3,378	1,089	1,500	618	506	783	-	
LEL0105*S6A	3,378	1,089	1,500	618	506	783	-	
LEL0115*S6A	3,378	1,089	1,500	618	506	783	-	
LEL0125*S6A	3,378	1,089	1,500	618	506	783	-	
LEL0155*S6A	3,378	1,089	1,500	618	506	783	-	
LEL0190*S6A	3,378	1,089	1,500	618	506	783	-	
LEL0250*S6A	3,378	1,089	1,500	618	506	783	-	
LEL0295*S6A	3,378	1,089	1,500	618	506	783	-	
LEL0350*S6A	3,378	1,089	1,500	618	506	783	-	
LEL0380*S6A	3,378	1,089	1,500	618	506	783	-	
LEL0040*S6E	3,378	1,089	1,500	618	506	783	843	
LEL0045*S4E	3,378	1,089	1,500	618	506	783	843	
LEL0045*S6E	3,378	1,089	1,500	618	506	783	843	
LEL0065*S6E	3,378	1,089	1,500	618	506	783	843	
LEL0070*S4E	3,378	1,089	1,500	618	506	783	843	
LEL0080*S6E	3,378	1,089	1,500	618	506	783	843	
LEL0090*S4E	3,378	1,089	1,500	618	506	783	843	
LEL0100*S6E	3,378	1,089	1,500	618	506	783	843	
LEL0130*S6E	3,378	1,089	1,500	618	506	783	843	
LEL0135*S4E	3,378	1,089	1,500	618	506	783	843	
LEL0155*S6E	3,378	1,089	1,500	618	506	783	843	
LEL0170*S6E	3,378	1,089	1,500	618	506	783	843	
LEL0180*S4E	3,378	1,089	1,500	618	506	783	843	
LEL0205*S6E	3,378	1,089	1,500	618	506	783	843	
LEL0220*S4E	3,378	1,089	1,500	618	506	783	843	
LEL0240*S6E	3,378	1,089	1,500	618	506	783	843	
LEL0255*S6E	3,378	1,089	1,500	618	506	783	843	
LEL0275*S4E	3,378	1,089	1,500	618	506	783	843	
LEL0310*S6E	3,378	1,089	1,500	618	506	783	843	

* = Voltage Code



FACTORY INSTALLED: A LA CARTE OPTION PACKAGES

Mechanical Options

Larkin Model	Factory Installed: A la Carte Options (List Price Adder US \$)				
	Mechanical Options				
	TXV	TXV & LLSV	QCF, TXV, & LLSV	TXV & LLSV - SPORLAN	QCF, TXV, and Sporlan LLSV
LEL0045*S6A	708	1,202	2,221	1,245	2,263
LEL0055*S6A	708	1,202	2,221	1,245	2,263
LEL0060*S6A	708	1,202	2,221	1,245	2,263
LEL0095*S6A	708	1,202	2,221	1,245	2,263
LEL0105*S6A	708	1,202	2,221	1,245	2,263
LEL0115*S6A	708	1,202	2,221	1,245	2,263
LEL0125*S6A	708	1,202	2,221	1,245	2,263
LEL0155*S6A	708	1,202	2,221	1,245	2,263
LEL0190*S6A	708	1,202	2,221	1,245	2,263
LEL0250*S6A	708	1,202	2,221	1,245	2,263
LEL0295*S6A	708	1,202	2,221	1,245	2,263
LEL0350*S6A	1,334	1,904	2,922	1,948	2,965
LEL0380*S6A	1,334	1,904	2,922	1,948	2,965
LEL0040*S6E	708	1,202	2,221	1,245	2,263
LEL0045*S4E	708	1,202	2,221	1,245	2,263
LEL0045*S6E	708	1,202	2,221	1,245	2,263
LEL0065*S6E	708	1,202	2,221	1,245	2,263
LEL0070*S4E	708	1,202	2,221	1,245	2,263
LEL0080*S6E	708	1,202	2,221	1,245	2,263
LEL0090*S4E	708	1,202	2,221	1,245	2,263
LEL0100*S6E	708	1,202	2,221	1,245	2,263
LEL0130*S6E	708	1,202	2,221	1,245	2,263
LEL0135*S4E	708	1,202	2,221	1,245	2,263
LEL0155*S6E	708	1,202	2,221	1,245	2,263
LEL0170*S6E	708	1,202	2,221	1,245	2,263
LEL0180*S4E	708	1,202	2,221	1,245	2,263
LEL0205*S6E	708	1,202	2,221	1,245	2,263
LEL0220*S4E	708	1,202	2,221	1,245	2,263
LEL0240*S6E	708	1,202	2,221	1,245	2,263
LEL0255*S6E	1,334	1,904	2,922	1,948	2,965
LEL0275*S4E	1,334	1,904	2,922	1,948	2,965
LEL0310*S6E	1,334	1,904	2,922	1,948	2,965
LEL0040*S6H	708	-	-	-	-
LEL0045*S4H	708	-	-	-	-
LEL0045*S6H	708	-	-	-	-
LEL0065*S6H	708	-	-	-	-
LEL0070*S4H	708	-	-	-	-
LEL0080*S6H	708	-	-	-	-
LEL0090*S4H	708	-	-	-	-
LEL0100*S6H	708	-	-	-	-
LEL0130*S6H	708	-	-	-	-
LEL0135*S4H	708	-	-	-	-
LEL0155*S6H	708	-	-	-	-
LEL0170*S6H	708	-	-	-	-
LEL0180*S4H	708	-	-	-	-
LEL0205*S6H	708	-	-	-	-
LEL0220*S4H	708	-	-	-	-
LEL0240*S6H	708	-	-	-	-
LEL0255*S6H	1,334	-	-	-	-
LEL0275*S4H	1,334	-	-	-	-
LEL0310*S6H	1,334	-	-	-	-

* = Voltage code



FACTORY INSTALLED: A LA CARTE OPTIONS

Coil, Drain Pan & Cabinet Options

Larkin Model	Factory Installed: A la Carte Options (List Price Adder US \$)								
	Coil Options				Drain Pan Options				Cabinet Option
	Coated Coil (Black)	Pro-Kote	Bronz-Glow or ElectroFin	Copper Coil	Stainless Drain Pan, Std Cabinet	Stainless Insulated Drain Pan, Stainless Cabinet	Double Wall Aluminum Stucco Drain Pan	Double Wall Stainless Steel Drain Pan	Stainless Steel Cabinet
LEL0045*S6A	798	1,772	2,725	1,005	862	999	218	862	1,713
LEL0055*S6A	798	1,772	2,725	1,348	862	999	218	862	1,713
LEL0060*S6A	798	1,772	2,725	1,348	862	999	218	862	1,713
LEL0095*S6A	1,187	1,772	2,725	2,091	954	1,025	300	954	1,982
LEL0105*S6A	1,187	1,772	2,725	2,091	954	1,025	300	954	1,982
LEL0115*S6A	1,187	1,772	2,725	2,792	954	1,025	300	954	2,257
LEL0125*S6A	1,187	1,772	2,725	2,792	954	1,025	300	954	2,257
LEL0155*S6A	1,733	1,809	2,725	3,140	1,004	1,112	372	1,004	2,257
LEL0190*S6A	1,733	1,809	2,725	4,192	1,004	1,112	372	1,004	2,257
LEL0250*S6A	2,181	1,848	2,725	5,124	1,093	1,224	457	1,093	2,501
LEL0295*S6A	2,746	1,889	3,255	6,413	1,158	1,393	503	1,158	2,792
LEL0350*S6A	2,746	1,926	3,620	7,059	1,216	1,511	571	1,216	2,907
LEL0380*S6A	2,746	1,926	3,620	7,059	1,216	1,511	571	1,216	2,907
LEL0040*S6E	-	-	2,725	1,005	-	999	218	-	2,125
LEL0045*S4E	-	-	2,725	-	-	999	218	-	2,024
LEL0045*S6E	-	-	2,725	1,341	-	999	218	-	2,125
LEL0065*S6E	-	-	2,725	2,003	-	1,025	300	-	2,263
LEL0070*S4E	-	-	2,725	-	-	1,025	300	-	2,263
LEL0080*S6E	-	-	2,725	2,003	-	1,025	300	-	2,263
LEL0090*S4E	-	-	2,725	-	-	1,025	300	-	2,263
LEL0100*S6E	-	-	2,725	2,737	-	1,025	300	-	2,263
LEL0130*S6E	-	-	2,725	2,998	-	1,112	372	-	2,398
LEL0135*S4E	-	-	2,725	-	-	1,112	372	-	2,398
LEL0155*S6E	-	-	2,725	4,112	-	1,112	372	-	2,398
LEL0170*S6E	-	-	2,931	5,457	-	1,224	457	-	2,786
LEL0180*S4E	-	-	2,884	-	-	1,224	457	-	2,786
LEL0205*S6E	-	-	2,884	5,457	-	1,224	457	-	2,786
LEL0220*S4E	-	-	3,255	-	-	1,393	503	-	3,027
LEL0240*S6E	-	-	3,255	6,413	-	1,393	503	-	3,027
LEL0255*S6E	-	-	3,620	7,059	-	1,511	571	-	3,310
LEL0275*S4E	-	-	3,620	-	-	1,511	571	-	3,335
LEL0310*S6E	-	-	3,620	7,059	-	1,511	571	-	3,310
LEL0040*S6H	-	-	2,725	1,005	-	999	218	-	2,125
LEL0045*S4H	-	-	2,725	-	-	999	218	-	2,024

* = Voltage code



FACTORY INSTALLED: A LA CARTE OPTIONS

Coil, Drain Pan & Cabinet Options

Larkin Model	Factory Installed: A la Carte Options (List Price Adder US \$)								
	Coil Options				Drain Pan Options				Cabinet Option
	Coated Coil (Black)	Pro-Kote	Bronz-Glow or ElectroFin	Copper Coil	Stainless Drain Pan, Std Cabinet	Stainless Insulated Drain Pan, Stainless Cabinet	Double Wall Aluminum Stucco Drain Pan	Double Wall Stainless Steel Drain Pan	Stainless Steel Cabinet
LEL0045*S6H	-	-	2,725	1,341	-	999	218	-	2,125
LEL0065*S6H	-	-	2,725	2,003	-	1,025	300	-	2,263
LEL0070*S4H	-	-	2,725	-	-	1,025	300	-	2,263
LEL0080*S6H	-	-	2,725	2,003	-	1,025	300	-	2,263
LEL0090*S4H	-	-	2,725	-	-	1,025	300	-	2,263
LEL0100*S6H	-	-	2,725	2,737	-	1,025	300	-	2,263
LEL0130*S6H	-	-	2,725	2,998	-	1,112	372	-	2,398
LEL0135*S4H	-	-	2,725	-	-	1,112	372	-	2,398
LEL0155*S6H	-	-	2,725	4,112	-	1,112	372	-	2,398
LEL0170*S6H	-	-	2,931	5,457	-	1,224	457	-	2,786
LEL0180*S4H	-	-	2,884	-	-	1,224	457	-	2,786
LEL0205*S6H	-	-	2,884	5,457	-	1,224	457	-	2,786
LEL0220*S4H	-	-	3,255	-	-	1,393	503	-	3,027
LEL0240*S6H	-	-	3,255	6,413	-	1,393	503	-	3,027
LEL0255*S6H	-	-	3,620	7,059	-	1,511	571	-	3,310
LEL0275*S4H	-	-	3,620	-	-	1,511	571	-	3,335
LEL0310*S6H	-	-	3,620	7,059	-	1,511	571	-	3,310



SHIPPED-LOOSE ACCESSORIES

A wide range of shipped-loose accessories are available to order. Can't find something? Other options and accessories might be available on a custom order basis. Please contact your local Sales Representative or Account Engineer for assistance.

Part Number	Description	List Price (US \$)	Notes
Room Thermostats			
2891040	Room Thermostat	\$490	-
28963301	Electronic Room Thermostat	\$798	-
Defrost Controls			
4267W	Adjustable Defrost Control/Fan Delay Switch	\$483	-
21340101	Defrost Timer (60 Hz)	\$576	-
5505R	30-Amp Contactor	\$644	Use as fan or heater contactor
Check Valves			
4146T	5/8" Suction Line Check Valve	\$213	-
5890C	7/8" Suction Line Check Valve	\$372	-
5889C	1 1/8" Suction Line Check Valve	\$703	-
2933022	1 3/8" Suction Line Check Valve	\$1,388	-
Drain Line Heaters			
5508Q	6 ft. Drain Line Heater (208-230V, 42 Watts)	\$247	-
5594P	12 ft. Drain Line Heater (208-230V, 84 Watts)	\$331	-
5595P	18 ft. Drain Line Heater (208-230V, 126 Watts)	\$435	-
5596P	36 ft. Drain Line Heater (208-230V, 252 Watts)	\$492	-
5597P	60 ft. Drain Line Heater (208-230V, 420 Watts)	\$885	-
Heat Exchangers			
24200004	Heat Exchanger used on 0045-0105 Air Defrost Models, 0040-0045 (6 FPI) Electric & Hot Gas Models, 0045-0070 (4 FPI) Electric Defrost Models	\$410	3/8" Liquid Connection OD, 5/8" Suction Connection OD, 14" Length, 2 lb Approx. Ship Wt.
24200005	Heat Exchanger used on 0115-0155 Air Defrost Models	\$448	3/8" Liquid Connection OD, 7/8" Suction Connection OD, 14" Length, 2 lb Approx. Ship Wt.
24200006	Heat Exchanger used on 0190 Air Defrost Model, 0065-0130 (6 FPI) Electric & Hot Gas Models, 0090 (4 FPI) Electric Defrost Model	\$467	1/2" Liquid Connection OD, 7/8" Suction Connection OD, 11" Length, 2 lb Approx. Ship Wt.
24200007	Heat Exchanger used on 0250-0350 Air Defrost Models, 0155-0170 (6 FPI) Electric Models, 0130-0170 (6 FPI) Hot Gas Models, 0135-0180 (4 FPI) Electric Defrost Models	\$523	1/2" Liquid Connection OD, 1-1/8" Suction Connection OD, 14" Length, 2 lb Approx. Ship Wt.
24200008	Heat Exchanger used on 0380 Air Defrost Model, 0205-0310 (6 FPI) Electric & Hot Gas Models, 0220-0275 (4 FPI) Electric Defrost Models	\$852	5/8" Liquid Connection OD, 1-3/8" Suction Connection OD, 14" Length, 3 lb Approx. Ship Wt.

Notes:

1. Selections made from matching suction connections of unit cooler to heat exchanger and then matching the hp
2. Low temperature models sized for -20F SST, 10F SCT @ 95F ambient, 5F sub cooling, R404A. Except, LUC has been sized for R448A
3. Medium temperature models sized for 25F SST, 20F SCT @ 95F ambient, 5F sub cooling, R404A. Except, LUC has been sized for R448A



SHIPPED-LOOSE ACCESSORIES

Part Number	List Price (US \$)	Capacity Range (BTUH)
Expansion Valves		
TXV024	\$571	24,000 BTUH and under
TXV036	\$571	24,000 BTUH to 36,000 BTUH
TXV060	\$925	36,000 BTUH to 60,000 BTUH

Part Number	List Price (US \$)	Size	Capacity Range (R-404A)			
			R404A/R507		R407A/R407C/R407F/R448A/R449A	
			Medium Temperature (BTUH) (25F SST, 95F Liquid)	Low Temperature (BTUH) (-20F SST, 95F Liquid)	Medium Temperature (BTUH) (25F SST, 95F Liquid)	Low Temperature (BTUH) (-20F SST, 95F Liquid)
29318018	\$209	3/8	11,000 BTUH and under	10,000 BTUH and under	15,000 BTUH and under	14,000 BTUH and under
29318019	\$198	3/8	11,000 BTUH to 20,000 BTH	10,000 BTUH to 18,000 BTUH	15,000 BTUH to 28,000 BTUH	14,000 BTUH to 25,000 BTUH
29318011	\$589	3/8	20,000 BTUH to 37,000 BTUH	18,000 BTUH to 33,000 BTUH	28,000 BTUH to 49,000 BTUH	25,000 BTUH to 46,000 BTUH

Note:

1. Selections made from matching suction connections of unit cooler to heat exchanger and then matching the hp
2. Low temperature models sized for -20F SST, 10F SCT @ 95F ambient, 5F sub cooling, R404A. Except, LUC has been sized for R448A
3. Medium temperature models sized for 25F SST, 20F SCT @ 95F ambient, 5F sub cooling, R404A. Except, LUC has been sized for R448A



SHIPPED—LOOSE ACCESSORIES

intelliGen Service Parts

Part Number	Description	List Price (US \$)
Field Mount Kit		
59755002	intelliGen Field Mount (iFM) Kit with 25ft sensor lead wires	\$2,600
Power Harness		
22699903	15ft harness for power, fan, defrost heater, solenoid valve	\$500
22699902	25ft harness for power, fan, defrost heater, solenoid valve	\$830
22699901	40ft harness for power, fan, defrost heater, solenoid valve	\$1,230
Temperature Sensors		
89904903	Temperature Sensor Kit - White Leads, 3ft	\$79
59755302	15ft sensor kit (3 temperature sensors, 1 pressure transducer harness)	\$270
59755301	40ft sensor kit (3 temperature sensors, 1 pressure transducer harness)	\$390
Pressure Transducer & Harnesses		
28911202	Pressure Transducer 0 - 300 PSIA	\$367
22515107	Pressure Transducer Harness, 15ft	\$110
22515105	Pressure Transducer Harness, 40ft	\$190
Transformers		
22529601	Transformer 120/24 volt - 40 VA	\$116
22529602	Transformer 240/24 volt - 40 VA	\$117
22529603	Transformer 460/24 - 40 VA	\$143
22529701	Transformer 575/24 - 40 VA	\$197
Electronic Expansion Valve (EXV) & Cables		
29326101	Carel EXV E2V11FWAEO - 3/8" x 3/8" Conn	\$1,263
29326201	Carel EXV E2V24FWAEO - 3/8" x 3/8" Conn	\$1,263
29326401	Carel EXV E2V24FSME0 - 5/8" X 5/8" Conn	\$1,263
29326501	Carel EXV E3V45ASTE0 - 7/8" X 1 3/8" Conn	\$2,481
29326601	Carel EXV E3V55ASTE0 - 7/8" X 1 3/8" Conn	\$2,481
22592201	Cable for Carel EXV, 10ft	\$150
22592103	Cable for Carel EXV, 25ft	\$260
22592102	Cable for Carel EXV, 40ft	\$320
Control Boards		
28918001S	iRC Main Control Board Replacement Kit	\$1,288
28918201S	iRCUI User Interface Replacement Kit	\$871
28918301S	iWC Webserver Card Replacement Kit	\$1,141
28918302S	Multi-system Control with Lead-lag (MSC) Card Field Mount Kit	\$1,575
28918401S	iIC Integration Card Replacement Kit	\$660
UI to iRC Ribbon Cables		
22602102	For Low Profile Unit Cooler, 14" Replacement Kit	\$318
Door Switch		
22543102	Door Switch Kit (includes door switch and 2 ft cable)	\$296

Part Number	Defrost Type	Voltage/Phase	Models	Color Finish	List Price (US \$)
intelliGen Retrofit Kits for Beacon II and QRC Controls					
89730101	Air & Electric Defrost	115/1	All	Stucco	\$2,200
89730102		208-230/1		White	\$2,200

Note:

- Unit mounted intelliGen is not available for Low Profile models with 208-230/3/60 and 460/1/60, and not available for Low Velocity Center Mount models with 460/1/60.
- intelliGen Field Mount (iFM) kit could be used for these models. Ask Heatcraft sales representatives for details.



HOT GAS REVERSE CYCLE KITS

Use the instructions below to help select the appropriate kit.
Still need help? Please contact your local Sales Representative or Account Engineer for assistance.

Selection Instructions:

1. Decide if kits are to be shipped-loose or factory-installed.
2. Select the correct TXV bypass kit based on unit model number and TXV style. Selections for units with the electric drain pan option are finished. For units with the standard hot gas drain pan, please proceed with instructions 3 and 4.
3. Select the appropriate drain pan and suction-line check valve kits based on unit model number. Drain pan and suction-line check valves and piping can be supplied by others but are necessary to complete the piping.
4. If room temperature is 0°F or below, please select an insulated drain pan as a factory-installed option. Selection for hot gas pan unit is finished.

When placing an order, please specify:

- Unit model number
- Drain pan type (hot gas or electric). If ordering hot gas pan, indicate whether unit is to have insulated pan.
- Reverse cycle kit option codes or part numbers. If ordering factory-mounted kits, please specify TXV style, refrigerant, saturated suction temperature (SST) and liquid temperature.

TXV Bypass Assembly Kits

Hot Gas Models	Factory Installed - List Price Adder (\$US)		Shipped-Loose		
	Type EG	Type SBF/SQE/BBI	Type EG	Type SBF/SQE/BBI	List Price Adder (\$US)
			Part Number	Part Number	
LEL0040*S6H^A	\$1,982	\$1,982	50756301	50756301	\$279
LEL0045*S6H^A	\$1,982	\$1,982	50756301	50756301	\$279
LEL0065*S6H^A	\$1,982	\$1,982	50756301	50756301	\$279
LEL0080*S6H^A	\$1,982	\$1,982	50756301	50756301	\$279
LEL0100*S6H^A	\$1,982	\$1,982	50756301	50756301	\$279
LEL0130*S6H^A	\$1,982	\$1,982	50756301	50756301	\$279
LEL0155*S6H^A	\$1,982	\$1,982	50756301	50756301	\$279
LEL0170*S6H^A	\$1,982	\$1,982	50756301	50756301	\$279
LEL0205*S6H^A	\$1,982	\$1,982	50756301	50756301	\$279
LEL0240*S6H^A	\$1,982	\$1,982	50756301	50756301	\$279
LEL0255*S6H^A	\$1,982	\$1,982	50756301	50756301	\$279
LEL0310*S6H^A	\$1,982	\$1,982	50756301	50756301	\$279
LEL0045*S4H^A	\$1,982	\$1,982	50756301	50756301	\$279
LEL0070*S4H^A	\$1,982	\$1,982	50756301	50756301	\$279
LEL0090*S4H^A	\$1,982	\$1,982	50756301	50756301	\$279
LEL0135*S4H^A	\$1,982	\$1,982	50756301	50756301	\$279
LEL0180*S4H^A	\$1,982	\$1,982	50756301	50756301	\$279
LEL0220*S4H^A	\$1,982	\$1,982	50756301	50756301	\$279
LEL0275*S4H^A	\$1,982	\$1,982	50756301	50756301	\$279

* Voltage (A = 115/1/60, B = 208-230/1/60M = 460/1/60)

^ Motor (M = 2-Speed EC, E = Single Speed EC, C = PSC Totally Enclosed)

Notes:

- Factory-Installed Kits include the TXV price. Customer must specify valve model, refrigerant and SST on order.
- Shipped-Loose Kits do NOT include the TXV price.



HOT GAS REVERSE CYCLE KITS

Suction and Drain Pan Check Valve Kits

Only available for models with the standard hot gas loop drain pan.

Hot Gas Models	Suction Line & Drain Pan Loop Check Valve Kit		
	Factory-Installed	Shipped-Loose	
	List Price (\$US)	Part Number	List Price (\$US)
LEL0040*S6H^A	\$2,837	50692204	\$679
LEL0045*S6H^A	\$2,837	50692204	\$679
LEL0065*S6H^A	\$2,837	50692204	\$679
LEL0080*S6H^A	\$2,837	50692204	\$679
LEL0100*S6H^A	\$2,837	50692205	\$679
LEL0130*S6H^A	\$2,837	50692205	\$679
LEL0155*S6H^A	\$2,837	50692206	\$679
LEL0170*S6H^A	\$2,837	50692205	\$679
LEL0205*S6H^A	\$2,837	50692206	\$679
LEL0240*S6H^A	\$2,837	50692206	\$679
LEL0255*S6H^A	\$2,837	50692206	\$679
LEL0310*S6H^A	\$2,837	50692206	\$679
LEL0045*S4H^A	\$2,837	50692204	\$679
LEL0070*S4H^A	\$2,837	50692204	\$679
LEL0090*S4H^A	\$2,837	50692205	\$679
LEL0135*S4H^A	\$2,837	50692205	\$679
LEL0180*S4H^A	\$2,837	50692206	\$679
LEL0220*S4H^A	\$2,837	50692206	\$679
LEL0275*S4H^A	\$2,837	50692206	\$679

Kit Description	Drain Pan Check Valve Kits		
	Factory-Installed	Shipped-Loose	
	List Price (\$US)	Part Number	List Price (\$US)
Rev Cycle Drain Pan Check Valve 5/8	\$1,462	50912904	\$419
Rev Cycle Drain Pan Check Valve 7/8	\$1,462	50912905	\$337
Rev Cycle Drain Pan Check Valve 1-1/8	\$1,462	50912906	\$384

* Voltage (A = 115/1/60, B = 208–230/1/60M = 460/1/60)

^ Motor (M = 2-Speed EC, E = Single Speed EC, C = PSC Totally Enclosed)

Notes:

- It is recommended that the customer order both check valve kits.
- Shipped-Loose Kits do NOT include the valve prices.
- The drain pan check valve kit can be ordered as an independent item, but the suction-line check valve kit must be ordered with the drain pan check valve kit in order to complete the piping



HOT GAS 3-PIPE KITS

Need a Hot Gas 3-Pipe Kit?

Use the instructions below to help select the appropriate kit.
Still need help? Please contact your local Sales Representative or Account Engineer for assistance.

Selection Instructions:

1. Decide if kits are to be shipped-loose or factory-installed.
2. Select the appropriate 3-pipe kits based on unit model number. Drain pan loop check valve and piping can be supplied by others but are necessary to complete the piping.
3. If room temperature is 0°F or below, please select an insulated drain pan as a factory-installed option. Selection for hot gas pan unit is finished.

When placing an order, please specify:

- Unit model number
- Drain pan type (hot gas or electric). If ordering hot gas pan, indicate whether unit is to have insulated pan.
- 3-Pipe kit option codes or part numbers. If ordering factory-mounted kits, please specify TXV style, refrigerant, saturated suction temperature (SST) and liquid temperature.

TXV Piping Kits

Hot Gas Models	Factory Installed - List Price Adder (\$US)		Shipped-Loose		
	Type EG	Type SBF/SQE/BBI	Type EG	Type SBF/SQE/BBI	List Price Adder (\$US)
			Part Number	Part Number	
LEL0040*S6H^A	\$1,901	\$1,901	50756302	50756302	\$203
LEL0045*S6H^A	\$1,901	\$1,901	50756302	50756302	\$203
LEL0065*S6H^A	\$1,901	\$1,901	50756302	50756302	\$203
LEL0080*S6H^A	\$1,901	\$1,901	50756302	50756302	\$203
LEL0100*S6H^A	\$1,901	\$1,901	50756302	50756302	\$203
LEL0130*S6H^A	\$1,901	\$1,901	50756302	50756302	\$203
LEL0155*S6H^A	\$1,901	\$1,901	50756302	50756302	\$203
LEL0170*S6H^A	\$1,901	\$1,901	50756302	50756302	\$203
LEL0205*S6H^A	\$1,901	\$1,901	50756302	50756302	\$203
LEL0240*S6H^A	\$1,901	\$1,901	50756302	50756302	\$203
LEL0255*S6H^A	\$1,901	\$1,901	50756302	50756302	\$203
LEL0310*S6H^A	\$1,901	\$1,901	50756302	50756302	\$203
LEL0045*S4H^A	\$1,901	\$1,901	50756302	50756302	\$203
LEL0070*S4H^A	\$1,901	\$1,901	50756302	50756302	\$203
LEL0090*S4H^A	\$1,901	\$1,901	50756302	50756302	\$203
LEL0135*S4H^A	\$1,901	\$1,901	50756302	50756302	\$203
LEL0180*S4H^A	\$1,901	\$1,901	50756302	50756302	\$203
LEL0220*S4H^A	\$1,901	\$1,901	50756302	50756302	\$203
LEL0275*S4H^A	\$1,901	\$1,901	50756302	50756302	\$203

* Voltage (A = 115/1/60, B = 208–230/1/60M = 460/1/60)

^ Motor (M = 2-Speed EC, E = Single Speed EC, C = PSC Totally Enclosed)

Notes:

- Factory-Installed Kits include the TXV price. Customer must specify valve model, refrigerant and SST on order.
- Shipped-Loose Kits do NOT include the TXV price.



HOT GAS 3-PIPE KITS

Drain Pan Check Valve Kits

Only available for models with the standard hot gas loop drain pan.

Hot Gas Models	Drain Pan Loop Check Valve Kit		
	Factory-Installed List Price (\$US)	Shipped-Loose	
		Part Number	List Price (\$US)
LEL0040*S6H*A	\$1,349	50692302	\$253
LEL0045*S6H*A	\$1,349	50692302	\$253
LEL0065*S6H*A	\$1,349	50692302	\$253
LEL0080*S6H*A	\$1,349	50692302	\$253
LEL0100*S6H*A	\$1,349	50692302	\$253
LEL0130*S6H*A	\$1,349	50692302	\$253
LEL0155*S6H*A	\$1,349	50692302	\$253
LEL0170*S6H*A	\$1,349	50692302	\$253
LEL0205*S6H*A	\$1,349	50692302	\$253
LEL0240*S6H*A	\$1,349	50692302	\$253
LEL0255*S6H*A	\$1,349	50692302	\$253
LEL0310*S6H*A	\$1,349	50692302	\$253
LEL0045*S4H*A	\$1,349	50692302	\$253
LEL0070*S4H*A	\$1,349	50692302	\$253
LEL0090*S4H*A	\$1,349	50692302	\$253
LEL0135*S4H*A	\$1,349	50692302	\$253
LEL0180*S4H*A	\$1,349	50692302	\$253
LEL0220*S4H*A	\$1,349	50692302	\$253
LEL0275*S4H*A	\$1,349	50692302	\$253

* Voltage (A = 115/1/60, B = 208-230/1/60M = 460/1/60)

^ Motor (M = 2-Speed EC, E = Single Speed EC, C = PSC Totally Enclosed)

Notes:

- Shipped-Loose Kits do NOT include the TXV price.

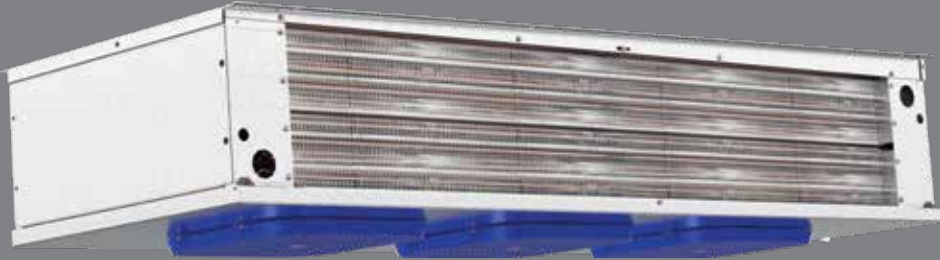

LOW VELOCITY CENTER MOUNT EVAPORATOR

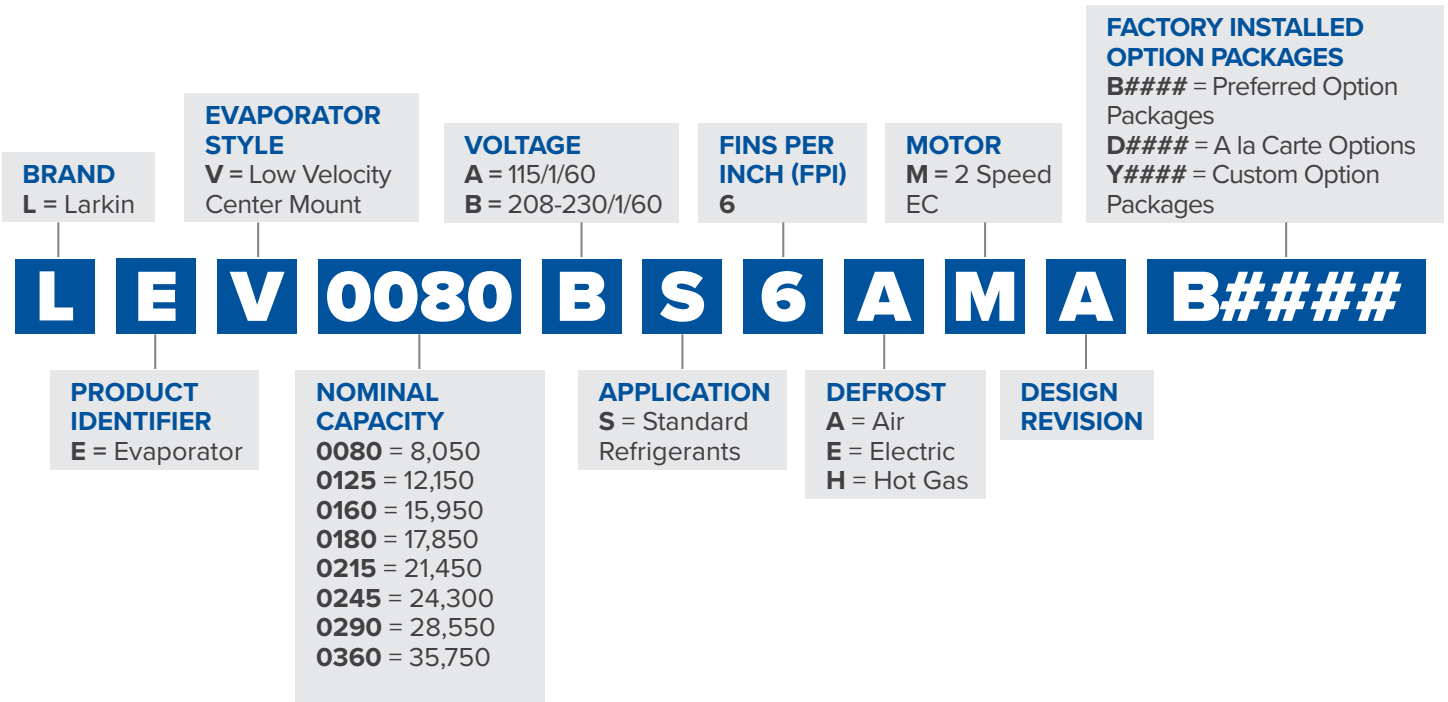



FEATURES & BENEFITS

CABINET

- Low height makes it ideal for low ceiling coolers - all models are only 14.5 inches tall, allowing for maximum headroom and more product storage
- Air moves across the ceiling in both directions providing even air distribution throughout the cooler
- Unit is designed to be mounted flush against the ceiling or suspended on rods
- Heavy-gauge grained aluminum cabinet cleans easily and looks attractive
- Cabinet design features improved access panels on each end for easy access to electrical and refrigeration components
- Captive stainless steel screws for easy service which prevent dropping/loss and prevent rust streaks or staining
- Improved wire management and routing
- Quick disconnect, waterproof plug and receptacle for each motor in all models
- Molded fan guard is made of strong, durable, NSF and UL Sanitation rated lightweight and damage resistant plastic material
- Liquid line solenoid wire harness is factory-installed for quick installation

COIL

- High-efficiency aluminum fins with full collars cover mechanically expanded copper tubes
- Coils are dehydrated and sealed at the factory
- Electric defrost models incorporate high quality tubular heaters and a standard fixed defrost termination thermostat
- Generous coil surface gives proper compressor balance
- Internally enhanced tubing and fin design for higher efficiency
- Optimized heater placement with reduced heater wattages
- Fixed defrost termination for electric models
- Hot gas defrost models come with a shipped-loose adjustable fan delay and defrost termination thermostat

DRAIN PAN

- Hinged drain pan for faster, easier and safer access and serviceability
- Tapered mounting provides proper slope for condensate drainage to one end of the unit
- Double drain pan eliminates drain pan sweating

MOTOR

- Motor rail is design for maximum strength and durability
- Motors are life lubricated and thermal overload protected
- 2 Speed EC Motors are factory-installed

CONTROL OPTIONS

- IntelliGen™ Refrigeration Controller (IRC) units come with a factory mounted controller, tested and calibrated with an electronic expansion valve, pressure transducer, temperature sensors, control board and user interface. Standard features include Door Sensor, Product Load Input and Alarm Output.
- Optional factory or field installable IntelliGen Webserver Card (iWC) enables local and remote monitoring on any phone, tablet or PC.
- Optional factory or field installable IntelliGen Integration Card (iIC) enables connectivity to BACnet and Modbus.

OTHER OPTIONS

- Units available with stainless steel housing and drain pan
- Air defrost units are available with various coil coatings options

OUTSTANDING FEATURES



Improved **wire management** and routing

Easily removable end access panel with captive fasteners

2 Speed EC motor standard

Optional IntelliGen™ Refrigeration Controller

Improved coil configuration

Hinged drain pan

Stucco finish





PREFERRED OPTION PACKAGES

Heatcraft now offers pre-defined kits that represent frequently ordered options or combinations of options. The preferred kits make it easier for customers to configure their units and may provide a savings over factory installed a la carte option selections.

Bundle options and save!

5% discount on bundled options selected over same a la carte options.

Refer to page 42 for A la carte Options

Preferred Options	Package Description
B0000	Standard Base
Standard Base +	
B0200	intelliGen™ Refrigeration Controller (R-404A/R-448A/R-449A)
B0201	intelliGen™ Refrigeration Controller (R-407A/C/F)

Example:

BASE MODEL 8,000 BTU Air Defrost (BEV0080AS6AMAB0000) \$7,368	+	B0200 (Standard base + intelliGen™ Refrigeration Control (R-404A/R-448A/R-449A) = \$3,116	=	\$10,484
		intelliGen™ Refrigeration Controller (R-404A/R-448A/R-449A)		<hr style="width: 100%;"/> \$10,648
		\$3,280		



AIR DEFROST PREFERRED MODELS

All models are DOE AWEF compliant. Please refer to AWEF and Net Capacity table in technical bulletin.

Air Defrost Models with 2 Speed EC Motors - 115/1/60

Base Model	List Price (\$US)		
	B0000	B0200	B0201
LEV0055AS6AMA	6,552	9,761	9,761
LEV0080AS6AMA	7,589	10,798	10,798
LEV0125AS6AMA	9,304	12,513	12,513
LEV0160AS6AMA	10,847	14,056	14,056
LEV0180AS6AMA	12,119	15,328	15,328
LEV0215AS6AMA	14,843	18,052	18,052
LEV0245AS6AMA	16,821	20,030	20,030
LEV0290AS6AMA	18,423	21,632	21,632
LEV0360AS6AMA	23,627	26,836	26,836

Air Defrost Models with 2 Speed EC Motors - 208-230/1/60

Base Model	List Price (\$US)		
	B0000	B0200	B0201
LEV0055BS6AMA	6,901	10,110	10,110
LEV0080BS6AMA	8,001	11,210	11,210
LEV0125BS6AMA	9,779	12,988	12,988
LEV0160BS6AMA	11,420	14,629	14,629
LEV0180BS6AMA	12,767	15,976	15,976
LEV0215BS6AMA	15,619	18,828	18,828
LEV0245BS6AMA	17,678	20,887	20,887
LEV0290BS6AMA	19,366	22,575	22,575
LEV0360BS6AMA	24,846	28,055	28,055



ELECTRIC DEFROST PREFERRED MODELS

All models are DOE AWEF compliant. Please refer to AWEF and Net Capacity table in technical bulletin.

Electric Defrost Models with 2 Speed EC Motors - 208-230/1/60

Base Model	List Price (\$US)		
	B0000	B0200	B0201
LEV0055BS6EMA	7,662	10,871	10,871
LEV0080BS6EMA	8,894	12,103	12,103
LEV0125BS6EMA	10,823	14,032	14,032
LEV0160BS6EMA	12,651	15,860	15,860
LEV0180BS6EMA	14,170	17,379	17,379
LEV0215BS6EMA	17,282	20,491	20,491
LEV0245BS6EMA	19,515	22,724	22,724
LEV0290BS6EMA	21,417	24,626	24,626
LEV0360BS6EMA	27,493	30,702	30,702

HOT GAS DEFROST BASE MODELS

All models are DOE AWEF compliant. Please refer to AWEF and Net Capacity table in technical bulletin.

Hot Gas Defrost Models with 2 Speed EC Motors - 115/1/60

Base Model	List Price (\$US)
	Standard Base
	B0000
LEV0080AS6HMA	8,651
LEV0125AS6HMA	9,819
LEV0160AS6HMA	12,369
LEV0180AS6HMA	13,845
LEV0215AS6HMA	16,899
LEV0245AS6HMA	19,098
LEV0290AS6HMA	20,946
LEV0360AS6HMA	26,885

Hot Gas Defrost Models with 2 Speed EC Motors - 208-230/1/60

Base Model	List Price (\$US)
	Standard Base
	B0000
LEV0080BS6HMA	9,121
LEV0125BS6HMA	10,330
LEV0160BS6HMA	13,034
LEV0180BS6HMA	14,598
LEV0215BS6HMA	17,800
LEV0245BS6HMA	20,079
LEV0290BS6HMA	22,043
LEV0360BS6HMA	28,292

LOW VELOCITY CENTER MOUNT EVAPORATOR



FACTORY INSTALLED: A LA CARTE OPTION PACKAGES

Refer to page 40 for preferred option packages.

Larkin Model	Factory Installed: A la Carte Options (List Price Adder US \$)												
	Electrical Options				Mechanical Options						Coil Options		
	intelliGen™	intelliGen Cards			TXV	TXV & LLSV	QCF, TXV, & LLSV	TXV & LLSV Sporlan	QCF, TXV & Sporlan LLSV	Master TXV & Sporlan LLSV	Coated Coil (Black)	Pro-Kote	Bronz-Glow or ElectroFin
Webserver Card	Multi-Sys-tem Control (MSC)	Integration Card											
LEV0055^S6AMA	3,378	1,089	1,500	618	908	1,403	2,432	1,403	2,432	1,403	1,986	1,736	3,477
LEV0080^S6AMA	3,378	1,089	1,500	618	908	1,403	2,432	1,403	2,432	1,403	1,986	1,736	3,477
LEV0125^S6AMA	3,378	1,089	1,500	618	908	1,403	2,432	1,403	2,432	1,403	2,865	2,562	3,477
LEV0160^S6AMA	3,378	1,089	1,500	618	908	1,403	2,432	1,403	2,432	1,403	2,865	2,562	5,662
LEV0180^S6AMA	3,378	1,089	1,500	618	908	1,403	2,432	1,403	2,432	1,403	2,865	2,562	5,662
LEV0215^S6AMA	3,378	1,089	1,500	618	908	1,403	2,432	1,403	2,432	1,403	2,865	3,491	5,662
LEV0245^S6AMA	3,378	1,089	1,500	618	908	1,403	NA	1,403	NA	1,403	4,474	4,065	6,730
LEV0290^S6AMA	3,378	1,089	1,500	618	908	1,403	NA	1,403	NA	1,403	4,474	4,065	6,730
LEV0360^S6AMA	3,378	1,089	1,500	618	1,490	2,156	NA	2,156	NA	2,156	5,734	5,517	7,796
Electric Defrost 2 Speed EC Motors													
LEV0055BS6EMA	3,378	1,591	1,500	618	908	1,403	2,432	1,403	2,432	1,403	NA	NA	3,477
LEV0080BS6EMA	3,378	1,591	1,500	618	908	1,403	2,432	1,403	2,432	1,403	NA	NA	3,477
LEV0125BS6EMA	3,378	1,591	1,500	618	908	1,403	2,432	1,403	2,432	1,403	NA	NA	3,477
LEV0160BS6EMA	3,378	1,591	1,500	618	908	1,403	2,432	1,403	2,432	1,403	NA	NA	5,662
LEV0180BS6EMA	3,378	1,591	1,500	618	908	1,403	2,432	1,403	2,432	1,403	NA	NA	5,662
LEV0215BS6EMA	3,378	1,591	1,500	618	908	1,403	2,432	1,403	2,432	1,403	NA	NA	5,662
LEV0245BS6EMA	3,378	1,591	1,500	618	908	1,403	1,403	1,403	1,403	1,403	NA	NA	6,730
LEV0290BS6EMA	3,378	1,591	1,500	618	908	1,403	1,403	1,403	1,403	1,403	NA	NA	6,730
LEV0360BS6EMA	3,378	1,591	1,500	618	1,490	2,156	2,156	2,156	2,156	2,156	NA	NA	7,796
Hot Gas Defrost 2 Speed EC Motors													
LEV0080^S6HMA	NA	NA	NA	NA	908	1,403	NA	1,403	NA	1,403	NA	NA	3,477
LEV0125^S6HMA	NA	NA	NA	NA	908	1,403	NA	1,403	NA	1,403	NA	NA	3,477
LEV0160^S6HMA	NA	NA	NA	NA	908	1,403	NA	1,403	NA	1,403	NA	NA	5,662
LEV0180^S6HMA	NA	NA	NA	NA	908	1,403	NA	1,403	NA	1,403	NA	NA	5,662
LEV0215^S6HMA	NA	NA	NA	NA	908	1,403	NA	1,403	NA	1,403	NA	NA	5,662
LEV0245^S6HMA	NA	NA	NA	NA	908	1,403	NA	1,403	NA	1,403	NA	NA	6,730
LEV0290^S6HMA	NA	NA	NA	NA	908	1,403	NA	1,403	NA	1,403	NA	NA	6,730
LEV0360^S6HMA	NA	NA	NA	NA	1,490	2,156	NA	2,156	NA	2,156	NA	NA	7,796

^A = 115/1/60, ^B = 208-230/1/60



SHIPPED-LOOSE ACCESSORIES

Air Defrost Models with 2 Speed EC Motors - 208-230/1/60

Part Number	Description	List Price (US \$)	Notes
Room Thermostats			
2891040	Room Thermostat	490	
28963301	Electronic Room Thermostat	798	
Defrost Controls			
4267W	Adjustable Defrost Control / Fan Delay Switch	483	
21340101	Electric Defrost Timer (60 Hz)	576	
5505R	30-Amp Contactor	644	Use as fan or heater contactor
Check Valves			
5890C	7/8" Suction Line Check Valve	372	
5889C	1 1/8" Suction Line Check Valve	703	
2933022	1 3/8" Suction Line Check Valve	1,388	
Drain Line Heaters			
5508Q	6 ft. Drain Line heater (208-230V, 42 Watts)	247	
5594P	12 ft. Drain Line heater (208-230V, 84 Watts)	331	
5595P	18 ft. Drain Line heater (208-230V, 126 Watts)	435	
5596P	36 ft. Drain Line heater (208-230V, 252 Watts)	492	
5597P	60 ft. Drain Line heater (208-230V, 420 Watts)	885	
Heat Exchangers			
24200008	Heat Exchanger used on all Air Defrost and Electric Defrost Models	852	5/8" Liquid Connection OD, 1-3/8" Suction Connection OD, 14" Length, 3 lb Approx. Ship Wt.

Notes:

1. Selections made from matching suction connections of unit cooler to heat exchanger and then matching the hp
2. Low temperature models sized for -20F SST, 10F SCT @ 95F ambient, 5F sub cooling, R404A. Except, LUC has been sized for R448A
3. Medium temperature models sized for 25F SST, 20F SCT @ 95F ambient, 5F sub cooling, R404A. Except, LUC has been sized for R448A



SHIPPED—LOOSE ACCESSORIES

Expansion Valves (TXV)

When placing order, please specify refrigerant type, saturated suction temperature (SST), liquid temperature and room temperature.

Part Number	Description	List Price (\$US)
TXV024		571
TXV036		571
TXV060		925
TXV120		1,173

Notes:

1. Selections made from matching suction connections of unit cooler to heat exchanger and then matching the hp
2. Low temperature models sized for -20F SST, 10F SCT @ 95F ambient, 5F sub cooling, R404A. Except, LUC has been sized for R448A
3. Medium temperature models sized for 25F SST, 20F SCT @ 95F ambient, 5F sub cooling, R404A. Except, LUC has been sized for R448A

LOW VELOCITY CENTER MOUNT EVAPORATOR



SHIPPED-LOOSE ACCESSORIES

intelliGen™ Service Parts

Part Number	Description	List Price (US \$)
Field Mount Kit		
59755002	intelliGen Field Mount (iFM) Kit with 25ft sensor lead wires	\$2,600
Power Harness		
22699903	15ft harness for power, fan, defrost heater, solenoid valve	\$500
22699902	25ft harness for power, fan, defrost heater, solenoid valve	\$830
22699901	40ft harness for power, fan, defrost heater, solenoid valve	\$1,230
Temperature Sensors		
89904903	Temperature Sensor Kit - White Leads, 3ft	\$79
59755302	15ft sensor kit (3 temperature sensors, 1 pressure transducer harness)	\$270
59755301	40ft sensor kit (3 temperature sensors, 1 pressure transducer harness)	\$390
Pressure Transducer & Harnesses		
28911202	Pressure Transducer 0 - 300 PSIA	\$367
22515107	Pressure Transducer Harness, 15ft	\$110
22515105	Pressure Transducer Harness, 40ft	\$190
Transformers		
22529601	Transformer 120/24 volt - 40 VA	\$116
22529602	Transformer 240/24 volt - 40 VA	\$117
22529603	Transformer 460/24 - 40 VA	\$143
22529701	Transformer 575/24 - 40 VA	\$197
Electronic Expansion Valve (EXV) & Cables		
29326101	Carel EXV E2V11FWAE0 - 3/8" x 3/8" Conn	\$1,263
29326201	Carel EXV E2V24FWAE0 - 3/8" x 3/8" Conn	\$1,263
29326401	Carel EXV E2V24FSME0 - 5/8" X 5/8" Conn	\$1,263
29326501	Carel EXV E3V45ASTE0 - 7/8" X 1 3/8" Conn	\$2,481
29326601	Carel EXV E3V55ASTE0 - 7/8" X 1 3/8" Conn	\$2,481
22592201	Cable for Carel EXV, 10ft	\$150
22592103	Cable for Carel EXV, 25ft	\$260
22592102	Cable for Carel EXV, 40ft	\$320
Control Boards		
28918001S	iRC Main Control Board Replacement Kit	\$1,288
28918201S	iRCUI User Interface Replacement Kit	\$871
28918301S	iWC Webserver Card Replacement Kit	\$1,141
28918302S	Multi-system Control with Lead-lag (MSC) Card Field Mount Kit	\$1,575
28918401S	iIC Integration Card Replacement Kit	\$660
UI to iRC Ribbon Cables		
22602101	For Center Mount/Low Velocity Center Mount Unit Cooler, 8" Replacement Kit	\$162
Door Switch		
22543102	Door Switch Kit (includes door switch and 2 ft cable)	\$296

LOW VELOCITY CENTER MOUNT EVAPORATOR



SHIPPED-LOOSE ACCESSORIES

intelliGen™ Service Parts

Part Number	Defrost Type	Voltage/Phase	Models	Color Finish	List Price (US \$)
intelliGen Retrofit Kits for Beacon II and QRC Controls					
89730201	Air & Electric Defrost	115/1 208-230/1	Low Velocity Center Mount: 050/0751	Stucco	\$2,200
89730202				White	\$2,200
89730205			Low Velocity Center Mount: 1001	Stucco	\$2,200
89730206				White	\$2,200
89730209			Low Velocity Center Mount: 130 - 3401	Stucco	\$2,200
89730210				White	\$2,200

Note:

1. Low Velocity Center Mount unit cooler models are based on the capacity digits in the model number for the kit size and part number. Unit mounted intelliGen is not available for Low Profile models with 208-230/3/60 and 460/1/60, and not available for Low Velocity Center Mount models with 460/1/60. intelliGen Field Mount (iFM) kit could be used for these models. Ask Heatcraft sales representatives for details.

TXV Bypass Kits

Hot Gas Reverse Cycle Kits (Hot Gas Models Only)

- Electric pan is standard on all hot gas models. Hot gas loop not available.
- Kits includes one check valve and piping for liquid bypass around expansion valve and instructions for field installation.

Larkin Models Used On	TXV TYPE	2025 List Price (\$US)	Bypass Kit Assy
LEV0125	EG, EGSE	707	50747611
LEV0125	SBF	707	50747612
LEV0125	SQE	707	50747613
LEV0125	BBI	707	50747614
LEV0160 to LEV0290	SBF, SQE	707	50747511
LEV0160 to LEV0290	BBI	707	50747512
LEV0160 to LEV0290	EG,EGSE	707	50747513
LEV0160 to LEV0245	EGSE-1-ZP, EGSE-2-ZP	707	50747515
LEV0360	SBF, SQE	707	50747311
LEV0360	BBI	707	50747312
LEV0360	EG	707	50747313
LEV0290	EBF	707	50747411

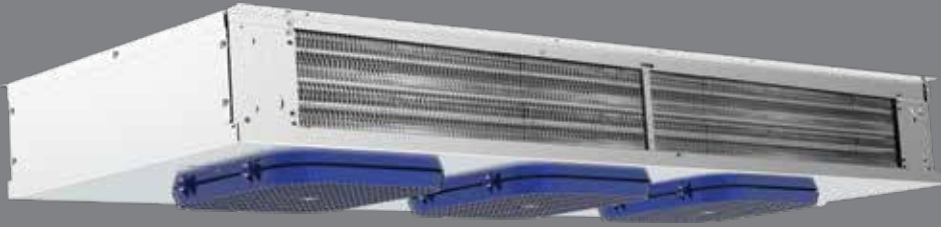

CENTER MOUNT EVAPORATOR

NOMENCLATURE

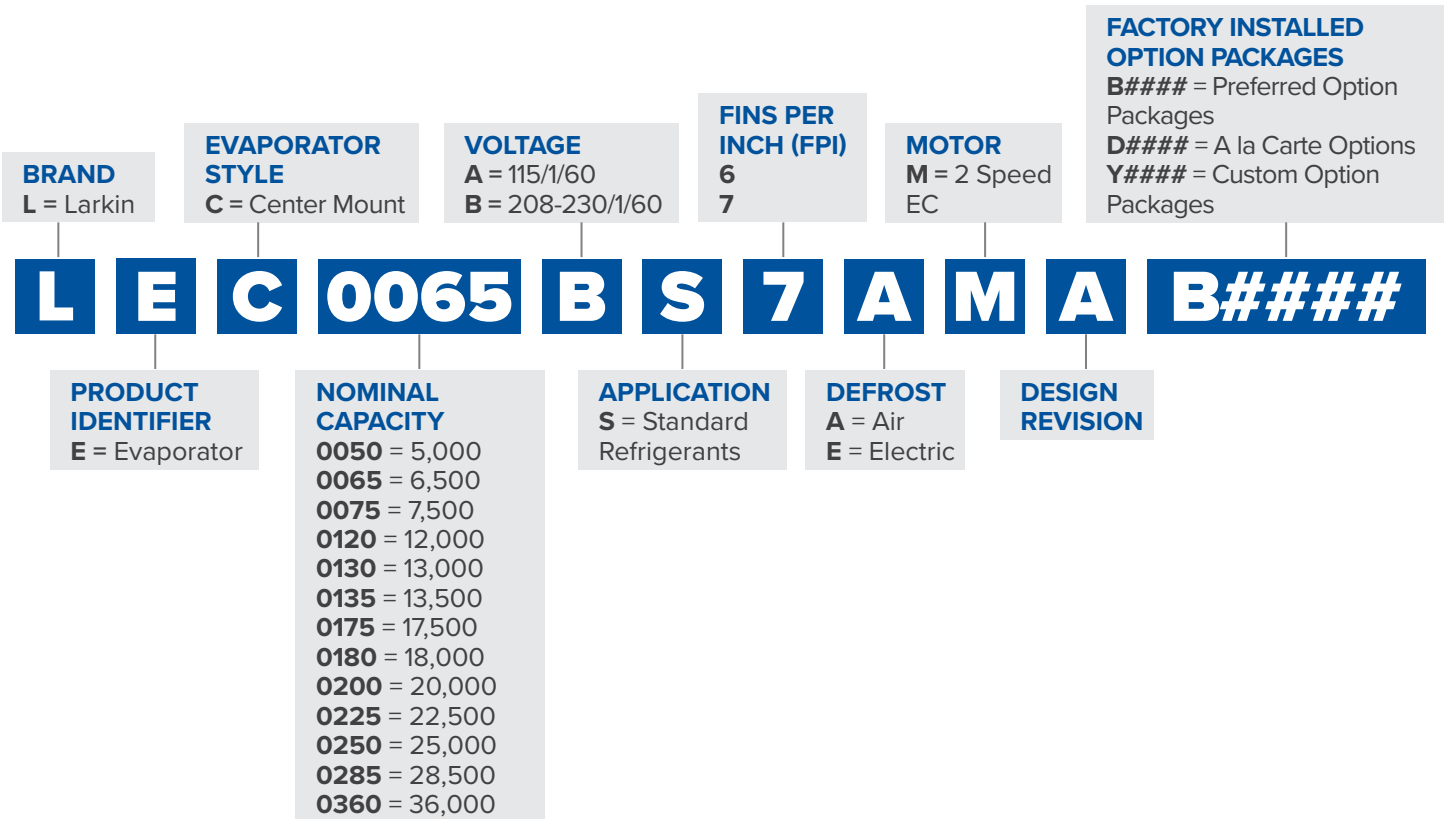



FEATURES & BENEFITS

CABINET

- Air moves across the ceiling in both directions providing even air distribution throughout the cooler
- Compact, ceiling mount and center mount design allows for shelving and storage of product around all walls
- Heavy-gauge grained aluminum cabinet cleans easily and looks attractive
- Cabinet design features improved access panels on each end for easy access to electrical and refrigeration components
- Captive stainless steel screws for easy service which prevent dropping/loss and prevent rust streaks or staining
- Improved wire management and routing
- Quick disconnect, waterproof plug and receptacle for each motor in all models
- Molded fan guard is made of strong, durable, NSF and UL Sanitation rated lightweight and damage resistant plastic material
- Liquid line solenoid wire harness is factory-installed for quick installation

COIL

- High-efficiency aluminum fins with full collars cover mechanically expanded copper tubes
- Coils are dehydrated and sealed at the factory
- Electric defrost models incorporate high quality tubular heaters and a standard fixed defrost termination thermostat
- Generous coil surface gives proper compressor balance
- Standard adjustable defrost termination fan delay thermostat
- Internally enhanced tubing and fin design for higher efficiency
- Optimized heater placement with reduced heater wattages
- Fixed defrost termination for electric, adjustable defrost termination for hot gas

DRAIN PAN

- Hinged drain pan for faster, easier and safer access and serviceability
- Tapered mounting provides proper slope for condensate drainage to one end of the unit
- Double drain pan eliminates drain pan sweating

MOTOR

- Motor rail is design for maximum strength and durability
- Motors are life lubricated and thermal overload protected
- 2 Speed EC Motors are factory-installed

CONTROL OPTIONS

- intelliGen™ Refrigeration Controller (IRC) units come with a factory mounted controller, tested and calibrated with an electronic expansion valve, pressure transducer, temperature sensors, control board and user interface. Standard features include Door Sensor, Product Load Input and Alarm Output.
- Optional factory or field installable intelliGen Webserver Card (iWC) enables local and remote monitoring on any phone, tablet or PC.
- Optional factory or field installable intelliGen Integration Card (iIC) enables connectivity to BACnet and Modbus.

OTHER OPTIONS

- Factory installed mounted components are available in these configurations:
- Pre-assembled units available with mounted TXV, liquid line solenoid valve and room thermostat
- Mounted TXV
- Mounted TXV and solenoid valve
- Units available with stainless steel housing and drain pan
- Air defrost units are available with various coil coatings options

OUTSTANDING FEATURES



Improved **wire management** and routing

Easily removable end access panel with captive fasteners

2 Speed EC motor standard

Optional IntelliGen™ Refrigeration Controller

Improved coil configuration

Hinged drain pan

Stucco finish



PREFERRED OPTION PACKAGES

Heatcraft now offers pre-defined kits that represent frequently ordered options or combinations of options. The preferred kits make it easier for customers to configure their units and may provide a savings over factory installed a la carte option selections.

Bundle options and save!

5% discount on bundled options selected over same a la carte options.

Refer to page 54 for a la carte options.

Preferred Options	Package Description
B0000	Standard Base
Standard Base + indicated options below	
B0200	intelliGen™ Refrigeration Controller (R-404A/R-448A/R-449A)
B0201	intelliGen™ Refrigeration Controller (R-407A/C/F)
B0300	Quick Response Controller (R-404A/R-448A/R-449A)
B0404	Mounted Components (TXV, Solenoid Valve, Elec. T'Stat - R-407A/C/F)
B0405	Mounted Components (TXV, Solenoid Valve, Elec. T'Stat - R-448A/R-449A)

Example:

<p style="text-align: center;">BASE MODEL 6,500 BTU Air Defrost (BEC0065AS7AMAB0000) \$4,286</p>	+	<p style="text-align: center;">B0403 (Standard base + Mounted TXV (R-404A) + Liquid Solenoid valve + Elec. Room T'stat) = \$2,016</p> <table border="1" style="width: 100%; text-align: center;"> <tr> <td style="padding: 5px;">TXV & LLSV</td> <td style="padding: 5px;">+</td> <td style="padding: 5px;">Elec. T'Stat</td> </tr> <tr> <td colspan="3" style="padding: 5px;">\$2,122</td> </tr> </table>	TXV & LLSV	+	Elec. T'Stat	\$2,122			=	<p style="text-align: center;">\$6,302</p> <hr style="width: 100%;"/> <p style="text-align: center;">\$6,408</p>
TXV & LLSV	+	Elec. T'Stat								
\$2,122										



AIR DEFROST PREFERRED MODELS

Please consult AWEF and Net Capacity table of Technical bulletin on page <<>> to confirm DOE compliance per model

Air Defrost Models with 2 Speed EC Motors - 115/1/60

Base Model	List Price (\$US)					
	B0000	B0200	B0201	B0403	B0404	B0405
LEC0065AS7AMA	4,415	7,624	7,624	6,492	6,492	6,492
LEC0095AS7AMB	6,391	9,600	9,600	8,468	8,468	8,468
LEC0130AS7AMA	6,481	9,690	9,690	8,558	8,558	8,558
LEC0175AS7AMA	7,928	11,137	11,137	10,005	10,005	10,005
LEC0200AS7AMA	8,857	12,066	12,066	10,934	10,934	10,934
LEC0225AS7AMA	9,720	12,929	12,929	11,797	11,797	11,797
LEC0250AS7AMA	11,180	14,389	14,389	13,257	13,257	13,257
LEC0285AS7AMA	12,227	15,436	15,436	14,304	14,304	14,304
LEC0360AS7AMA	14,967	18,176	18,176	17,044	17,044	17,044

Air Defrost Models with 2 Speed EC Motors - 208-230/1/60

Base Model	List Price (\$US)					
	B0000	B0200	B0201	B0403	B0404	B0405
LEC0065BS7AMA	4,709	7,918	7,918	6,786	6,786	6,786
LEC0095BS7AMB	6,743	9,952	9,952	8,820	8,820	8,820
LEC0130BS7AMA	6,836	10,045	10,045	8,913	8,913	8,913
LEC0175BS7AMA	8,366	11,575	11,575	10,443	10,443	10,443
LEC0200BS7AMA	9,277	12,486	12,486	11,354	11,354	11,354
LEC0225BS7AMA	10,142	13,351	13,351	12,219	12,219	12,219
LEC0250BS7AMA	11,673	14,882	14,882	13,750	13,750	13,750
LEC0285BS7AMA	12,735	15,944	15,944	14,812	14,812	14,812
LEC0360BS7AMA	15,521	18,730	18,730	17,598	17,598	17,598



ELECTRIC DEFROST PREFERRED MODELS

All models are DOE AWEF compliant. Please refer to AWEF and Net Capacity table in technical bulletin.

Electric Defrost Models with 2 Speed EC Motors - 208-230/1/60

Base Model	List Price (\$US)					
	B0000	B0200	B0201	B0403	B0404	B0405
LEC0050BS6EMA	5,794	9,003	9,003	7,871	7,871	7,871
LEC0075BS6EMA	8,084	11,293	11,293	10,161	10,161	10,161
LEC0120BS6EMA	10,168	13,377	13,377	12,245	12,245	12,245
LEC0135BS6EMA	11,126	14,335	14,335	13,203	13,203	13,203
LEC0180BS6EMA	14,423	17,632	17,632	16,500	16,500	16,500
LEC0255BS6EMA	15,125	18,334	18,334	17,202	17,202	17,202
LEC0280BS6EMA	17,013	20,222	20,222	19,090	19,090	19,090



FACTORY INSTALLED: A LA CARTE OPTION PACKAGES

Refer to page 51 for preferred option packages.

Air Defrost 2 Speed EC Motors

Larkin Model	Factory Installed: A la Carte Options (List Price Adder US \$)						
	Electrical Options					Mech. Room T'stat	Elec. Room T'stat
	intelliGen™	intelliGen Cards			Integration Card		
Webserver Card		Multi-System Control (MSC)					
LEC0065^S7AMA	3,378	1,089	1,500	618	506	783	
LEC0095^S7AMB	3,378	1,089	1,500	618	506	783	
LEC0130^S7AMA	3,378	1,089	1,500	618	506	783	
LEC0175^S7AMA	3,378	1,089	1,500	618	506	783	
LEC0200^S7AMA	3,378	1,089	1,500	618	506	783	
LEC0225^S7AMA	3,378	1,089	1,500	618	506	783	
LEC0250^S7AMA	3,378	1,089	1,500	618	506	783	
LEC0285^S7AMA	3,378	1,089	1,500	618	506	783	
LEC0360^S7AMA	3,378	1,089	1,500	618	506	783	

^A = 115/1/60, ^B = 208-230/1/60

Electric Defrost 2 Speed EC Motors

Larkin Model	Factory Installed: A la Carte Options (List Price Adder US \$)						
	Electrical Options					Mech. Room T'stat	Elec. Room T'stat
	intelliGen™	intelliGen Cards			Integration Card		
Webserver Card		Multi-System Control (MSC)					
LEC0050BS6EMA	3,378	1,089	1,500	618	506	783	
LEC0075BS6EMA	3,378	1,089	1,500	618	506	783	
LEC0120BS6EMA	3,378	1,089	1,500	618	506	783	
LEC0135BS6EMA	3,378	1,089	1,500	618	506	783	
LEC0180BS6EMA	3,378	1,089	1,500	618	506	783	
LEC0255BS6EMA	3,378	1,089	1,500	618	506	783	
LEC0280BS6EMA	3,378	1,089	1,500	618	506	783	



FACTORY INSTALLED: A LA CARTE OPTION PACKAGES

Refer to page 51 for preferred option packages.

Air Defrost Defrost 2 Speed EC Motors

Larkin Model	Factory Installed: A la Carte Options (List Price Adder US \$)								
	Mechanical Options						Coil Options		
	TXV	TXV & LLSV	QCF, TXV, & LLSV	TXV & LLSV - SPORLAN	QCF, TXV, and Sporlan LLSV	Master TXV and Sporlan LLSV	Coated Coil (Black)	Pro-Kote	Bronz-Glow or ElectroFin
LEC0065^S7AMA	908	1,403	2,432	1,403	2,432	1,403	1,144	1,016	3,477
LEC0095^S7AMB	908	1,403	2,432	1,403	1,403	1,403	1,571	1,392	3,674
LEC0130^S7AMA	908	1,403	2,432	1,403	2,432	1,403	1,571	1,392	3,674
LEC0175^S7AMA	908	1,403	2,432	1,403	2,432	1,403	1,906	1,977	3,916
LEC0200^S7AMA	908	1,403	2,432	1,403	2,432	1,403	1,906	1,977	4,112
LEC0225^S7AMA	908	1,403	2,432	1,403	2,432	1,403	1,906	1,977	4,349
LEC0250^S7AMA	908	1,403	2,432	1,403	2,432	1,403	2,348	2,460	4,722
LEC0285^S7AMA	908	1,403	2,432	1,403	2,432	1,403	2,348	2,460	5,027
LEC0360^S7AMA	908	1,403	2,432	1,403	2,432	1,403	2,994	3,168	5,705

^A = 115/1/60, ^B = 208-230/1/60

Electric Defrost 2 Speed EC Motors

Larkin Model	Factory Installed: A la Carte Options (List Price Adder US \$)								
	Mechanical Options						Coil Options		
	TXV	TXV & LLSV	QCF, TXV, & LLSV	TXV & LLSV - SPORLAN	QCF, TXV, and Sporlan LLSV	Master TXV and Sporlan LLSV	Coated Coil (Black)	Pro-Kote	Bronz-Glow or ElectroFin
LEC0050BS6EMA	908	1,403	2,432	1,403	2,432	1,403	NA	NA	3,477
LEC0075BS6EMA	908	1,403	2,432	1,403	2,432	1,403	NA	NA	3,477
LEC0120BS6EMA	908	1,403	2,432	1,403	2,432	1,403	NA	NA	3,674
LEC0135BS6EMA	908	1,403	2,432	1,403	2,432	1,403	NA	NA	3,674
LEC0180BS6EMA	908	1,403	2,432	1,403	2,432	1,403	NA	NA	5,027
LEC0255BS6EMA	908	1,403	2,432	1,403	2,432	1,403	NA	NA	6,497
LEC0280BS6EMA	908	1,403	2,432	1,403	2,432	1,403	NA	NA	6,497



SHIPPED-LOOSE ACCESSORIES

A wide range of shipped-lose accessories are available to order. Can't find something? Other options and accessories might be available on a custom order basis. Please contact your local Sales Representative or Account Engineer for assistance.

Part Number	Description	List Price (\$US)	Notes
Room Thermostats			
2891040	Room Thermostats	\$490	-
28963301	Electronic Room Thermostat	\$798	-
Defrost Controls			
4267W	Adjustable Defrost Control / Fan Delay Switch	\$483	-
Check Valves			
5890C	7/8" Suction Line Check Valve	\$372	-
5889C	1 1/8" Suction Line Check Valve	\$703	-
Drain Line Heaters			
5508Q	6 ft. Drain Line heater (208-230V, 42 Watts)	\$247	-
5594P	12 ft. Drain Line heater (208-230V, 84 Watts)	\$331	-
5595P	18 ft. Drain Line heater (208-230V, 126 Watts)	\$435	-
5596P	36 ft. Drain Line heater (208-230V, 252 Watts)	\$492	-
5597P	60 ft. Drain Line heater (208-230V, 420 Watts)	\$885	-
Heat Exchangers			
24200007	Heat Exchanger used on all Air Defrost and Electric Defrost Models	\$523	1/2" Liquid Connection OD, 1-1/8" Suction Connection OD, 14" Length, 2 lb Approx. Ship Wt.

Expansion Valves (TXV)

When placing order, please specify refrigerant type, saturated suction temperature (SST), liquid temperature and room temperature.

Part Number	List Price (\$US)	Capacity Range (BTUH)
TXV024	571	24,000 BTUH and under
TXV036	571	24,000 BTUH to 36,000 BTUH
TXV060	925	36,000 BTUH to 60,000 BTUH



SHIPPED-LOOSE ACCESSORIES

Liquid-line Solenoid Valves (LLSV)

Part Number	List Price (\$US)	Size	Capacity Range			
			R404A/R507		R407A/R407C/R407F/R448A/R449A	
			Medium Temperature (BTUH) (25F SST, 95F Liquid)	Low Temperature (BTUH) (-20F SST, 95F Liquid)	Medium Temperature (BTUH) (25F SST, 95F Liquid)	Low Temperature (BTUH) (-20F SST, 95F Liquid)
29318018	209	3/8	11,000 BTUH and under	10,000 BTUH and under	15,000 BTUH and under	14,000 BTUH and under
29318019	198	3/8	11,000 BTUH to 20,000 BTUH	10,000 BTUH to 18,000 BTUH	15,000 BTUH to 28,000 BTUH	14,000 BTUH to 25,000 BTUH
29318011	589	3/8	20,000 BTUH to 37,000 BTUH	18,000 BTUH to 33,000 BTUH	28,000 BTUH to 49,000 BTUH	25,000 BTUH to 46,000 BTUH

Notes:

1. Selections made from matching suction connections of unit cooler to heat exchanger and then matching the hp
2. Low temperature models sized for -20F SST, 10F SCT @ 95F ambient, 5F sub cooling, R404A. Except, LUC has been sized for R448A
3. Medium temperature models sized for 25F SST, 20F SCT @ 95F ambient, 5F sub cooling, R404A. Except, LUC has been sized for R448A

CENTER MOUNT EVAPORATOR



SHIPPED—LOOSE ACCESSORIES

intelliGen™ Service Parts

Part Number	Description	List Price (US \$)			
Field Mount Kit					
59755002	intelliGen Field Mount (iFM) Kit with 25ft sensor lead wires	\$2,600			
Power Harness					
22699903	15ft harness for power, fan, defrost heater, solenoid valve	\$500			
22699902	25ft harness for power, fan, defrost heater, solenoid valve	\$830			
22699901	40ft harness for power, fan, defrost heater, solenoid valve	\$1,230			
Temperature Sensors					
89904903	Temperature Sensor Kit - White Leads, 3ft	\$79			
59755302	15ft sensor kit (3 temperature sensors, 1 pressure transducer harness)	\$270			
59755301	40ft sensor kit (3 temperature sensors, 1 pressure transducer harness)	\$390			
Pressure Transducer & Harnesses					
28911202	Pressure Transducer 0 - 300 PSIA	\$367			
22515107	Pressure Transducer Harness, 15ft	\$110			
22515105	Pressure Transducer Harness, 40ft	\$190			
Transformers					
22529601	Transformer 120/24 volt - 40 VA	\$116			
22529602	Transformer 240/24 volt - 40 VA	\$117			
22529603	Transformer 460/24 - 40 VA	\$143			
22529701	Transformer 575/24 - 40 VA	\$197			
Electronic Expansion Valve (EXV) & Cables					
29326101	Carel EXV E2V11FWAE0 - 3/8" x 3/8" Conn	\$1,263			
29326201	Carel EXV E2V24FWAE0 - 3/8" x 3/8" Conn	\$1,263			
29326401	Carel EXV E2V24FSME0 - 5/8" X 5/8" Conn	\$1,263			
29326501	Carel EXV E3V45ASTE0 - 7/8" X 1 3/8" Conn	\$2,481			
29326601	Carel EXV E3V55ASTE0 - 7/8" X 1 3/8" Conn	\$2,481			
22592201	Cable for Carel EXV, 10ft	\$150			
22592103	Cable for Carel EXV, 25ft	\$260			
22592102	Cable for Carel EXV, 40ft	\$320			
Control Boards					
28918001S	iRC Main Control Board Replacement Kit	\$1,288			
28918201S	iRCUI User Interface Replacement Kit	\$871			
28918301S	iWC Webserver Card Replacement Kit	\$1,141			
28918302S	Multi-system Control with Lead-lag (MSC) Card Field Mount Kit	\$1,575			
28918401S	iIC Integration Card Replacement Kit	\$660			
UI to iRC Ribbon Cables					
22602101	For Center Mount/Low Velocity Center Mount Unit Cooler, 8" Replacement Kit	\$162			
Door Switch					
22543102	Door Switch Kit (includes door switch and 2 ft cable)	\$296			
Part Number	Defrost Type	Voltage/Phase	Models	Color Finish	List Price (US \$)
intelliGen Retrofit Kits for Beacon II and QRC Controls					
89730201	Air & Electric Defrost	115/1	Center Mount: All1	Stucco	\$2,200
89730202		208-230/1		White	\$2,200

Note:

- Center Mount unit cooler models use 89730201 or 89730202 kit part numbers only. intelliGen Field Mount (iFM) kit could be used for these models. Ask Heatcraft sales representatives for details.

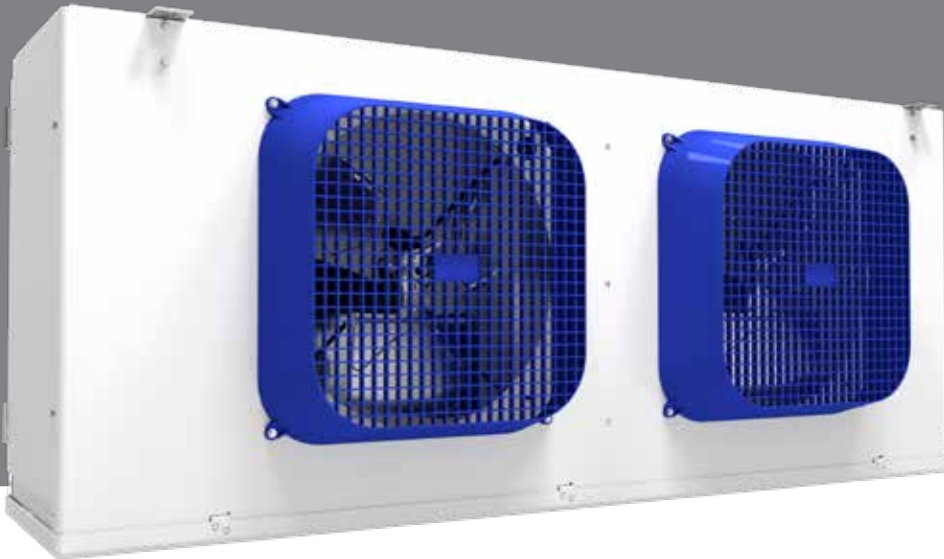

MEDIUM PROFILE EVAPORATOR

NOMENCLATURE

PRODUCT IDENTIFIER E = Evaporator	NOMINAL CAPACITY x100 = BTU/h	APPLICATION S = Standard Refrigerants	DEFROST A = Air E = Electric H = Hot Gas	REVISION						
L	E	M	0185	A	S	8	A	M	B	B0000
BRAND L = Larkin	EVAPORATOR STYLE M = Medium Profile	VOLTAGE A = 115/1/60 B = 208-230/1/60 C = 208-230/3/60 M = 460/1/60 D = 460/3/60 E = 575/3/60 L = 575/1/60	FINS PER INCH (fpi) 4 6 8	MOTOR M = 2 Speed EC E = Fixed Speed EC C = PSC Totally Enclosed V = Variable Speed EC P = PSC	FACTORY-INSTALLED OPTION PACKAGES B#### = Preferred Option Packages D#### = A la Carte Options Y#### = Custom Option Packages					



FEATURES & BENEFITS

CABINET

- Removable, hinged access panels
- Plastic, molded fan guards
- Schrader valve provided for suction pressure measurement
- External equalizer connection
- Heavy-gauge aluminum cabinet
- All electrical components factory wired to terminal board and identified, making it easy to field wire the unit
- Sweat connections to reduce potential for leaks
- Internal panels are isolated for quiet operation
- Liquid line solenoid wire harness is factory-installed for quick installation

DRAIN PAN

- Hinged drain pan for easy access
- Large diameter drain fitting (3/4" ID)
- Rear-draining fitting for space savings

COIL

- Patented Thermo-Flex™ coil design allows the coil to “flex” during periods of defrost resulting in expansion of the coil surface. By eliminating the possibility of wear at critical stress areas, the integrity and longevity of the unit are dramatically increased (Patent Number 5,584,340)
- Coil heater slots have been enlarged for easier replacement
- Electric Defrost Models with 2-Speed EC Motors have fixed defrost termination / fan delay and heater limit thermostats
- Reliable nickel steel alloy defrost heater elements
- Heaters are coil face mounted for easy access

MOTORS

- Motors plug into wiring harness for easier servicing
- 2-Speed EC motors standard for 115V, 208-230V, and 460V applications
- Thermally protected, lifetime-lubricated single phase PSC motors (optional)

CONTROLS OPTIONS

- IntelliGen™ Refrigeration Controller (IRC) units come with factory mounted, tested and calibrated with an electronic expansion valve, pressure transducer, temperature sensors, control board and User Interface. Available standard features include Door Sensor, Product Load Input and Alarm Output.
- Optional field installable IntelliGen Webserver Card (iWC) enables local and remote monitoring on any phone, tablet or PC.
- Optional field installable IntelliGen Integration Card (iIC) enables connectivity to BACnet and Modbus.

OTHER OPTIONS

- Totally enclosed single phase PSC motors available as an option for 208-230, 460, and some 575 voltage models.
- Factory installed mounted components are available in these configurations:
 - Pre-assembled units come with mounted TXV, liquid line solenoid valve and room thermostat
 - Mounted TXV
 - Mounted TXV and solenoid valve
 - Mounted room thermostat
- Most models available with glycol circuiting (see glycol product brochure)
- Units available with stainless steel housing and drain pan
- Units available with Bronze-Glow coil coating (air, electric and hot gas)
- Units available with copper fins (6 FPI models only)
- Air defrost units available with polyester coated fins or various coil coating options
- Units available with insulated drain pan
- Ship-loose air sock collar available
- Wire fan guards
- Export crating

OUTSTANDING FEATURES

Hinged, Removable Access Panels allow for easy access

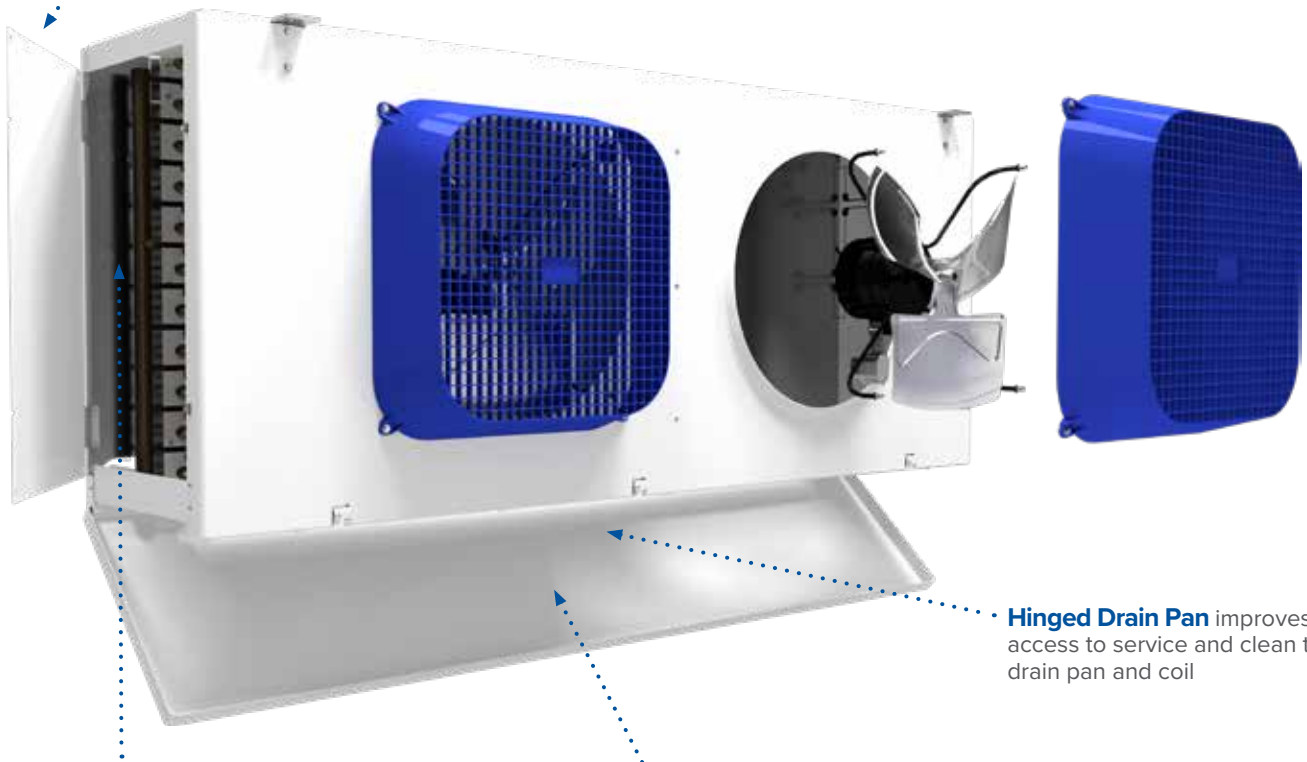

Optional Factory Mounted Components - Choose from IntelliGen™ Refrigeration Controller

Hinged Drain Pan improves access to service and clean the drain pan and coil

Angled Drain Fitting has been incorporated in the Medium Profile drain pan to provide additional space under the unit for shelving and product storage. This design feature helps to mitigate some of the height gain due to the new efficiency standards.



PREFERRED OPTION PACKAGES

Heatcraft now offers pre-defined kits that represent frequently ordered options or combinations of options. The preferred kits make it easier for customers to configure their units and may provide a savings over factory installed a la carte option selections.

Bundle options and save!

5% discount on bundled options selected over same a la carte options.

Refer to page 72 for a la carte options.

Preferred Options	Package Description
B0000	Standard Base
Standard Base +	
B0200	intelliGen™ Refrigeration Controller (R-404A/R-448A/R-449A)
B0201	intelliGen™ Refrigeration Controller (R-407A/C/F)
B0403	Mounted Components (TXV, Solenoid Valve, Elec. T'Stat - R-404A)
B0404	Mounted Components (TXV, Solenoid Valve, Elec. T'Stat - R-407A/C/F)
B0405	Mounted Components (TXV, Solenoid Valve, Elec. T'Stat - R-448A/R-449A)

Example:

BASE MODEL 18,500 BTU Air Defrost (BEM0185AS8AMBB0000) \$8,160	+	B0403 (Standard Base + Mounted TXV (R-404A) + Liquid Solenoid valve + Electric Room T'stat) = \$2,069	=	\$10,229		
		TXV & LLSV	+	Elec. T'Stat	=	\$10,338
		\$2,178				



AIR DEFROST PREFERRED MODELS

Please consult AWEF and Net Capacity table of Technical bulletin to confirm DOE compliance per model.

Air Defrost Models with 2-Speed EC Motors - 115/1/60

Base Model	List Price (\$US)					
	B0000	B0200	B0201	B0403	B0404	B0405
LEM0185AS8AMB	8,405	12,917	12,917	10,537	10,537	10,537
LEM0225AS8AMB	9,717	14,229	14,229	11,849	11,849	11,849
LEM0405AS8AMB	14,085	18,597	18,597	16,217	16,217	16,217
LEM0475AS8AMB	17,318	21,830	21,830	19,450	19,450	19,450
LEM0575AS8AMB	21,959	26,471	26,471	24,666	24,666	24,666
LEM0675AS8AMB	25,606	30,118	30,118	28,313	28,313	28,313
LEM0775AS8AMB	30,387	34,899	34,899	33,094	33,094	33,094
LEM0975AS8AMB	31,971	36,483	36,483	34,678	34,678	34,678

Air Defrost Models with 2-Speed EC Motors - 208-230/1/60

Base Model	List Price (\$US)					
	B0000	B0200	B0201	B0403	B0404	B0405
LEM0185BS8AMB	8,535	13,047	13,047	10,667	10,667	10,667
LEM0225BS8AMB	9,834	14,346	14,346	11,966	11,966	11,966
LEM0405BS8AMB	14,323	18,835	18,835	16,455	16,455	16,455
LEM0475BS8AMB	17,559	22,071	22,071	19,691	19,691	19,691
LEM0575BS8AMB	22,333	26,845	26,845	25,040	25,040	25,040
LEM0675BS8AMB	25,978	30,490	30,490	28,685	28,685	28,685
LEM0775BS8AMB	30,867	35,379	35,379	33,574	33,574	33,574
LEM0975BS8AMB	32,460	36,972	36,972	35,167	35,167	35,167
LEM1115BS8AMB	38,418	42,930	42,930	41,882	41,882	41,882

Air Defrost Models with 2-Speed EC Motors - 460/1/60

Base Model	List Price (\$US)					
	B0000	B0200	B0201	B0403	B0404	B0405
LEM0185MS8AMB	11,131	15,643	15,643	13,263	13,263	13,263
LEM0225MS8AMB	12,829	17,341	17,341	14,961	14,961	14,961
LEM0405MS8AMB	18,682	23,194	23,194	20,814	20,814	20,814
LEM0475MS8AMB	22,904	27,416	27,416	25,036	25,036	25,036
LEM0575MS8AMB	29,127	33,639	33,639	31,834	31,834	31,834
LEM0675MS8AMB	33,882	38,394	38,394	36,589	36,589	36,589
LEM0775MS8AMB	40,266	44,778	44,778	42,973	42,973	42,973
LEM0975MS8AMB	42,339	46,851	46,851	45,046	45,046	45,046
LEM1115MS8AMB	50,111	54,623	54,623	53,575	53,575	53,575



ELECTRIC DEFROST PREFERRED MODELS

Please consult AWEF and Net Capacity table of Technical bulletin to confirm DOE compliance per model.

Electric Defrost Models with 2-Speed EC Motors - 208-230/1/60

Base Model	List Price (\$US)					
	B0000	B0200	B0201	B0403	B0404	B0405
LEM0125BS6EMA	9,943	14,455	14,455	12,075	12,075	12,075
LEM0135BS6EMA	11,543	16,055	16,055	13,675	13,675	13,675
LEM0250BS6EMA	15,924	20,436	20,436	18,056	18,056	18,056
LEM0300BS6EMA	20,927	25,439	25,439	23,059	23,059	23,059
LEM0370BS6EMA	23,653	28,165	28,165	26,360	26,360	26,360
LEM0475BS6EMA	28,173	32,685	32,685	30,880	30,880	30,880
LEM0125BS4EMA	10,277	14,789	14,789	12,409	12,409	12,409
LEM0225BS4EMA	14,588	19,100	19,100	16,720	16,720	16,720
LEM0250BS4EMA	19,081	23,593	23,593	21,213	21,213	21,213
LEM0325BS4EMA	21,439	25,951	25,951	24,146	24,146	24,146
LEM0420BS4EMA	27,193	31,705	31,705	29,900	29,900	29,900

Electric Defrost Models with 2-Speed EC Motors - 208-230/3/60

Base Model	List Price (\$US)					
	B0000	B0200	B0201	B0403	B0404	B0405
LEM0125CS6EMA	9,943	14,455	14,455	12,075	12,075	12,075
LEM0135CS6EMA	11,543	16,055	16,055	13,675	13,675	13,675
LEM0250CS6EMA	15,924	20,436	20,436	18,056	18,056	18,056
LEM0300CS6EMA	20,927	25,439	25,439	23,059	23,059	23,059
LEM0370CS6EMA	23,653	28,165	28,165	26,360	26,360	26,360
LEM0475CS6EMA	28,173	32,685	32,685	30,880	30,880	30,880
LEM0595CS6EMA	31,562	36,074	36,074	34,269	34,269	34,269
LEM0735CS6EMA	35,130	39,642	39,642	37,837	37,837	37,837
LEM0850CS6EMA	38,626	43,138	43,138	42,090	42,090	42,090
LEM0125CS4EMA	10,277	14,789	14,789	12,409	12,409	12,409
LEM0225CS4EMA	14,588	19,100	19,100	16,720	16,720	16,720
LEM0250CS4EMA	19,081	23,593	23,593	21,213	21,213	21,213
LEM0325CS4EMA	21,439	25,951	25,951	24,146	24,146	24,146
LEM0420CS4EMA	27,193	31,705	31,705	29,900	29,900	29,900
LEM0490CS4EMA	30,498	35,010	35,010	33,205	33,205	33,205
LEM0620CS4EMA	33,861	38,373	38,373	36,568	36,568	36,568
LEM0720CS4EMA	38,358	42,870	42,870	41,822	41,822	41,822



ELECTRIC DEFROST PREFERRED MODELS

Please consult AWEF and Net Capacity table of Technical bulletin to confirm DOE compliance per model.

Electric Defrost Models with 2-Speed EC Motors - 460/1/60

Base Model	List Price (\$US)					
	B0000	B0200	B0201	B0403	B0404	B0405
LEM0125MS6EMA	12,970	17,482	17,482	15,102	15,102	15,102
LEM0135MS6EMA	15,057	19,569	19,569	17,189	17,189	17,189
LEM0250MS6EMA	20,772	25,284	25,284	22,904	22,904	22,904
LEM0300MS6EMA	27,296	31,808	31,808	29,428	29,428	29,428
LEM0370MS6EMA	30,852	35,364	35,364	33,559	33,559	33,559
LEM0475MS6EMA	36,746	41,258	41,258	39,453	39,453	39,453
LEM0595MS6EMA	41,168	45,680	45,680	43,875	43,875	43,875
LEM0735MS6EMA	45,823	50,335	50,335	48,530	48,530	48,530
LEM0850MS6EMA	50,383	54,895	54,895	53,847	53,847	53,847
LEM0125MS4EMA	13,408	17,920	17,920	15,540	15,540	15,540
LEM0225MS4EMA	19,028	23,540	23,540	21,160	21,160	21,160
LEM0250MS4EMA	24,889	29,401	29,401	27,021	27,021	27,021
LEM0325MS4EMA	27,967	32,479	32,479	30,674	30,674	30,674
LEM0420MS4EMA	35,471	39,983	39,983	38,178	38,178	38,178
LEM0490MS4EMA	39,780	44,292	44,292	42,487	42,487	42,487
LEM0620MS4EMA	44,165	48,677	48,677	46,872	46,872	46,872
LEM0720MS4EMA	50,033	54,545	54,545	53,497	53,497	53,497



AIR DEFROST BASE MODELS

Please consult AWEF and Net Capacity table of Technical bulletin to confirm DOE compliance per model.

Air Defrost Base Models - 115/1/60

2-Speed EC Motors		VSEC Motors		Fixed Speed EC Motors		PSC Motors	
Base Model	List Price (\$US)	Base Model	List Price (\$US)	Base Model	List Price (\$US)	Base Model	List Price (\$US)
	B0000		B0000		B0000		B0000
LEM0185AS8AMB	8,405	LEM0185AS8AVB	8,872	LEM0185AS8AEB	7,965	LEM0185AS8APB	6,826
LEM0225AS8AMB	9,717	LEM0225AS8AVB	10,185	LEM0225AS8AEB	9,210	LEM0225AS8APB	8,082
LEM0405AS8AMB	14,085	LEM0405AS8AVB	14,995	LEM0405AS8AEB	13,351	LEM0405AS8APB	11,109
LEM0475AS8AMB	17,318	LEM0475AS8AVB	18,228	LEM0475AS8AEB	16,415	LEM0475AS8APB	14,202
LEM0575AS8AMB	21,959	LEM0575AS8AVB	23,325	LEM0575AS8AEB	20,814	LEM0575AS8APB	17,459
LEM0675AS8AMB	25,606	LEM0675AS8AVB	26,970	LEM0675AS8AEB	24,268	LEM0675AS8APB	20,946
LEM0775AS8AMB	30,387	LEM0775AS8AVB	32,209	LEM0775AS8AEB	28,801	LEM0775AS8APB	24,338
LEM0975AS8AMB	31,971	LEM0975AS8AVB	33,794	LEM0975AS8AEB	30,305	LEM0975AS8APB	25,857

Air Defrost Base Models - 208-230/1/60

2-Speed EC Motors		VSEC Motors		Fixed Speed EC Motors		PSC Motors		Totally Enclosed PSC Motors	
Base Model	List Price (\$US)	Base Model	List Price (\$US)	Base Model	List Price (\$US)	Base Model	List Price (\$US)	Base Model	List Price (\$US)
	B0000		B0000		B0000		B0000		B0000
LEM0185BS8AMB	8,535	LEM0185BS8AVB	9,003	LEM0185BS8AEB	8,089	LEM0185BS8APB	6,947	LEM0185BS8ACB	7,415
LEM0225BS8AMB	9,834	LEM0225BS8AVB	10,303	LEM0225BS8AEB	9,322	LEM0225BS8APB	8,196	LEM0225BS8ACB	8,658
LEM0405BS8AMB	14,323	LEM0405BS8AVB	15,236	LEM0405BS8AEB	13,575	LEM0405BS8APB	11,335	LEM0405BS8ACB	12,242
LEM0475BS8AMB	17,559	LEM0475BS8AVB	18,471	LEM0475BS8AEB	16,643	LEM0475BS8APB	14,432	LEM0475BS8ACB	15,339
LEM0575BS8AMB	22,333	LEM0575BS8AVB	23,698	LEM0575BS8AEB	21,168	LEM0575BS8APB	17,813	LEM0575BS8ACB	19,172
LEM0675BS8AMB	25,978	LEM0675BS8AVB	27,341	LEM0675BS8AEB	24,620	LEM0675BS8APB	21,300	LEM0675BS8ACB	22,660
LEM0775BS8AMB	30,867	LEM0775BS8AVB	32,691	LEM0775BS8AEB	29,257	LEM0775BS8APB	24,799	LEM0775BS8ACB	26,611
LEM0975BS8AMB	32,460	LEM0975BS8AVB	34,288	LEM0975BS8AEB	30,769	LEM0975BS8APB	26,322	LEM0975BS8ACB	28,135
LEM1115BS8AMB	38,418	LEM1115BS8AVB	40,759	LEM1115BS8AEB	36,413	LEM1115BS8APB	30,673	LEM1115BS8ACB	33,001



AIR DEFROST BASE MODELS

Please consult AWEF and Net Capacity table of Technical bulletin to confirm DOE compliance per model.

Air Defrost Base Models - 460/1/60

2-Speed EC Motors		PSC Motors		Totally Enclosed PSC Motors	
Base Model	List Price (\$US)	Base Model	List Price (\$US)	Base Model	List Price (\$US)
	B0000		B0000		B0000
LEM0185MS8AMB	11,131	LEM0185MS8APB	7,302	LEM0185MS8ACB	7,767
LEM0225MS8AMB	12,829	LEM0225MS8APB	8,551	LEM0225MS8ACB	9,018
LEM0405MS8AMB	18,682	LEM0405MS8APB	12,027	LEM0405MS8ACB	12,935
LEM0475MS8AMB	22,904	LEM0475MS8APB	15,122	LEM0475MS8ACB	16,027
LEM0575MS8AMB	29,127	LEM0575MS8APB	18,838	LEM0575MS8ACB	20,195
LEM0675MS8AMB	33,882	LEM0675MS8APB	22,328	LEM0675MS8ACB	23,690
LEM0775MS8AMB	40,266	LEM0775MS8APB	26,169	LEM0775MS8ACB	27,982
LEM0975MS8AMB	42,339	LEM0975MS8APB	27,696	LEM0975MS8ACB	29,505
LEM1115MS8AMB	50,111	LEM1115MS8APB	32,436	LEM1115MS8ACB	34,763

Air Defrost Base Models - 575/1/60

PSC Motors	
Base Model	List Price (\$US)
	B0000
LEM0185LS8APB	7,247
LEM0225LS8APB	8,487
LEM0405LS8APB	12,269
LEM0475LS8APB	15,429
LEM0575LS8APB	19,212
LEM0675LS8APB	22,779
LEM0775LS8APB	26,698
LEM0975LS8APB	28,245
LEM1115LS8APB	32,198



ELECTRIC DEFROST BASE MODELS

Please consult AWEF and Net Capacity table of Technical bulletin to confirm DOE compliance per model.

Electric Defrost Base Models - 208-230/1/60

2-Speed EC Motors		VSEC Motors		Fixed Speed EC Motors		PSC Motors		Totally Enclosed PSC Motors	
Base Model	List Price (\$US)	Base Model	List Price (\$US)	Base Model	List Price (\$US)	Base Model	List Price (\$US)	Base Model	List Price (\$US)
	B0000		B0000		B0000		B0000		B0000
LEM0125BS6EMA	9,943	LEM0125BS6EVA	10,412	LEM0125BS6EEA	9,383	LEM0125BS6EPA	8,259	LEM0125BS6ECA	8,724
LEM0135BS6EMA	11,543	LEM0135BS6EVA	12,010	LEM0135BS6EEA	10,891	LEM0135BS6EPA	9,782	LEM0135BS6ECA	10,246
LEM0250BS6EMA	15,924	LEM0250BS6EVA	16,836	LEM0250BS6EEA	15,026	LEM0250BS6EPA	12,808	LEM0250BS6ECA	13,711
LEM0300BS6EMA	20,927	LEM0300BS6EVA	21,838	LEM0300BS6EEA	19,743	LEM0300BS6EPA	17,575	LEM0300BS6ECA	18,476
LEM0370BS6EMA	23,653	LEM0370BS6EVA	25,021	LEM0370BS6EEA	22,315	LEM0370BS6EPA	18,991	LEM0370BS6ECA	20,345
LEM0475BS6EMA	28,173	LEM0475BS6EVA	29,541	LEM0475BS6EEA	26,581	LEM0475BS6EPA	23,296	LEM0475BS6ECA	24,650
LEM0125BS4EMA	10,277	LEM0125BS4EVA	10,744	LEM0125BS4EEA	9,696	LEM0125BS4EPA	8,579	LEM0125BS4ECA	9,042
LEM0225BS4EMA	14,588	LEM0225BS4EVA	15,498	LEM0225BS4EEA	13,762	LEM0225BS4EPA	11,534	LEM0225BS4ECA	12,438
LEM0250BS4EMA	19,081	LEM0250BS4EVA	19,990	LEM0250BS4EEA	18,003	LEM0250BS4EPA	15,819	LEM0250BS4ECA	16,719
LEM0325BS4EMA	21,439	LEM0325BS4EVA	22,804	LEM0325BS4EEA	20,227	LEM0325BS4EPA	16,882	LEM0325BS4ECA	18,236
LEM0420BS4EMA	27,193	LEM0420BS4EVA	28,561	LEM0420BS4EEA	25,659	LEM0420BS4EPA	22,363	LEM0420BS4ECA	23,719

Electric Defrost Base Models - 208-230/3/60

2-Speed EC Motors		VSEC Motors		Fixed Speed EC Motors		PSC Motors		Totally Enclosed PSC Motors	
Base Model	List Price (\$US)	Base Model	List Price (\$US)	Base Model	List Price (\$US)	Base Model	List Price (\$US)	Base Model	List Price (\$US)
	B0000		B0000		B0000		B0000		B0000
LEM0125CS6EMA	9,943	LEM0125CS6EVA	10,412	LEM0125CS6EEA	9,383	LEM0125CS6EPA	8,259	LEM0125CS6ECA	8,724
LEM0135CS6EMA	11,543	LEM0135CS6EVA	12,010	LEM0135CS6EEA	10,891	LEM0135CS6EPA	9,782	LEM0135CS6ECA	10,246
LEM0250CS6EMA	15,924	LEM0250CS6EVA	16,836	LEM0250CS6EEA	15,026	LEM0250CS6EPA	12,808	LEM0250CS6ECA	13,711
LEM0300CS6EMA	20,927	LEM0300CS6EVA	21,838	LEM0300CS6EEA	19,743	LEM0300CS6EPA	17,575	LEM0300CS6ECA	18,476
LEM0370CS6EMA	23,653	LEM0370CS6EVA	25,021	LEM0370CS6EEA	22,315	LEM0370CS6EPA	18,991	LEM0370CS6ECA	20,345
LEM0475CS6EMA	28,173	LEM0475CS6EVA	29,541	LEM0475CS6EEA	26,581	LEM0475CS6EPA	23,296	LEM0475CS6ECA	24,650
LEM0595CS6EMA	31,562	LEM0595CS6EVA	33,385	LEM0595CS6EEA	29,777	LEM0595CS6EPA	25,345	LEM0595CS6ECA	27,150
LEM0735CS6EMA	35,130	LEM0735CS6EVA	36,956	LEM0735CS6EEA	33,146	LEM0735CS6EPA	28,745	LEM0735CS6ECA	30,550
LEM0850CS6EMA	38,626	LEM0850CS6EVA	40,907	LEM0850CS6EEA	36,442	LEM0850CS6EPA	30,894	LEM0850CS6ECA	33,151
LEM0125CS4EMA	10,277	LEM0125CS4EVA	10,744	LEM0125CS4EEA	9,696	LEM0125CS4EPA	8,579	LEM0125CS4ECA	9,042
LEM0225CS4EMA	14,588	LEM0225CS4EVA	15,498	LEM0225CS4EEA	13,762	LEM0225CS4EPA	11,534	LEM0225CS4ECA	12,438
LEM0250CS4EMA	19,081	LEM0250CS4EVA	19,990	LEM0250CS4EEA	18,003	LEM0250CS4EPA	15,819	LEM0250CS4ECA	16,719
LEM0325CS4EMA	21,439	LEM0325CS4EVA	22,804	LEM0325CS4EEA	20,227	LEM0325CS4EPA	16,882	LEM0325CS4ECA	18,236
LEM0420CS4EMA	27,193	LEM0420CS4EVA	28,561	LEM0420CS4EEA	25,659	LEM0420CS4EPA	22,363	LEM0420CS4ECA	23,719
LEM0490CS4EMA	30,498	LEM0490CS4EVA	32,323	LEM0490CS4EEA	28,773	LEM0490CS4EPA	24,333	LEM0490CS4ECA	26,136
LEM0620CS4EMA	33,861	LEM0620CS4EVA	35,682	LEM0620CS4EEA	31,946	LEM0620CS4EPA	27,537	LEM0620CS4ECA	29,339
LEM0720CS4EMA	38,358	LEM0720CS4EVA	39,867	LEM0720CS4EEA	36,190	LEM0720CS4EPA	30,475	LEM0720CS4ECA	32,795

MEDIUM PROFILE EVAPORATOR



ELECTRIC DEFROST BASE MODELS

Please consult AWEF and Net Capacity table of Technical bulletin to confirm DOE compliance per model.

Electric Defrost Base Models - 460/1/60

2-Speed EC Motors		PSC Motors		Totally Enclosed PSC Motors	
Base Model	List Price (\$US)	Base Model	List Price (\$US)	Base Model	List Price (\$US)
	B0000		B0000		B0000
LEM0125MS6EMA	12,970	LEM0125MS6EPA	8,758	LEM0125MS6ECA	9,222
LEM0135MS6EMA	15,057	LEM0135MS6EPA	10,279	LEM0135MS6ECA	10,742
LEM0250MS6EMA	20,772	LEM0250MS6EPA	13,764	LEM0250MS6ECA	14,665
LEM0300MS6EMA	27,296	LEM0300MS6EPA	18,530	LEM0300MS6ECA	19,432
LEM0370MS6EMA	30,852	LEM0370MS6EPA	20,419	LEM0370MS6ECA	21,770
LEM0475MS6EMA	36,746	LEM0475MS6EPA	24,727	LEM0475MS6ECA	26,082
LEM0595MS6EMA	41,168	LEM0595MS6EPA	27,254	LEM0595MS6ECA	29,057
LEM0735MS6EMA	45,823	LEM0735MS6EPA	30,656	LEM0735MS6ECA	32,459
LEM0850MS6EMA	50,383	LEM0850MS6EPA	33,282	LEM0850MS6ECA	35,538
LEM0125MS4EMA	13,408	LEM0125MS4EPA	9,066	LEM0125MS4ECA	9,529
LEM0225MS4EMA	19,028	LEM0225MS4EPA	12,490	LEM0225MS4ECA	13,394
LEM0250MS4EMA	24,889	LEM0250MS4EPA	16,776	LEM0250MS4ECA	17,678
LEM0325MS4EMA	27,967	LEM0325MS4EPA	17,830	LEM0325MS4ECA	19,184
LEM0420MS4EMA	35,471	LEM0420MS4EPA	23,798	LEM0420MS4ECA	25,153
LEM0490MS4EMA	39,780	LEM0490MS4EPA	26,237	LEM0490MS4ECA	28,040
LEM0620MS4EMA	44,165	LEM0620MS4EPA	29,434	LEM0620MS4ECA	31,237
LEM0720MS4EMA	50,033	LEM0720MS4EPA	32,929	LEM0720MS4ECA	35,242



ELECTRIC DEFROST BASE MODELS

Please consult AWEF and Net Capacity table of Technical bulletin to confirm DOE compliance per model.

Electric Defrost Base Models - 460/3/60

PSC Motors		Totally Enclosed PSC Motors	
Base Model	List Price (\$US)	Base Model	List Price (\$US)
	B0000		B0000
LEM0125DS6EPA	8,758	LEM0125DS6ECA	9,222
LEM0135DS6EPA	10,279	LEM0135DS6ECA	10,742
LEM0250DS6EPA	13,764	LEM0250DS6ECA	14,665
LEM0300DS6EPA	18,530	LEM0300DS6ECA	19,432
LEM0370DS6EPA	20,419	LEM0370DS6ECA	21,770
LEM0475DS6EPA	24,727	LEM0475DS6ECA	26,082
LEM0595DS6EPA	27,254	LEM0595DS6ECA	29,057
LEM0735DS6EPA	30,656	LEM0735DS6ECA	32,459
LEM0850DS6EPA	33,282	LEM0850DS6ECA	35,538
LEM0125DS4EPA	9,066	LEM0125DS4ECA	9,529
LEM0225DS4EPA	12,490	LEM0225DS4ECA	13,394
LEM0250DS4EPA	16,776	LEM0250DS4ECA	17,678
LEM0325DS4EPA	17,830	LEM0325DS4ECA	19,184
LEM0420DS4EPA	23,798	LEM0420DS4ECA	25,153
LEM0490DS4EPA	26,237	LEM0490DS4ECA	28,040
LEM0620DS4EPA	29,434	LEM0620DS4ECA	31,237
LEM0720DS4EPA	32,929	LEM0720DS4ECA	34,299

Electric Defrost Base Models - 575/3/60

PSC Motors	
Base Model	List Price (\$US)
	B0000
LEM0125ES6EPA	8,937
LEM0135ES6EPA	10,479
LEM0250ES6EPA	14,037
LEM0300ES6EPA	18,908
LEM0370ES6EPA	20,830
LEM0475ES6EPA	25,224
LEM0595ES6EPA	27,803
LEM0735ES6EPA	31,268
LEM0850ES6EPA	33,948
LEM0125ES4EPA	9,248
LEM0225ES4EPA	12,737
LEM0250ES4EPA	17,111
LEM0325ES4EPA	18,185
LEM0420ES4EPA	24,278
LEM0490ES4EPA	26,764
LEM0620ES4EPA	30,022
LEM0720ES4EPA	33,583



HOT GAS DEFROST BASE MODELS

Please consult AWEF and Net Capacity table of Technical bulletin to confirm DOE compliance per model.

Hot Gas Defrost Base Models - 115/1/60

2-Speed EC Motors		VSEC Motors		Fixed Speed EC Motors		PSC Motors	
Base Model	List Price (\$US)	Base Model	List Price (\$US)	Base Model	List Price (\$US)	Base Model	List Price (\$US)
	B0000		B0000		B0000		B0000
LEM0250AS6HMA	14,921	LEM0250AS6HVA	15,832	LEM0250AS6HEA	13,882	LEM0250AS6HPA	11,687
LEM0300AS6HMA	19,514	LEM0300AS6HVA	20,426	LEM0300AS6HEA	18,156	LEM0300AS6HPA	16,004
LEM0370AS6HMA	22,149	LEM0370AS6HVA	23,517	LEM0370AS6HEA	20,610	LEM0370AS6HPA	17,317
LEM0475AS6HMA	26,422	LEM0475AS6HVA	27,791	LEM0475AS6HEA	24,584	LEM0475AS6HPA	21,329
LEM0595AS6HMA	29,562	LEM0595AS6HVA	31,387	LEM0595AS6HEA	27,505	LEM0595AS6HPA	23,116
LEM0735AS6HMA	32,924	LEM0735AS6HVA	34,750	LEM0735AS6HEA	30,633	LEM0735AS6HPA	26,275
LEM0225AS4HMA	14,534	LEM0225AS4HVA	15,446	LEM0225AS4HEA	13,522	LEM0225AS4HPA	11,325
LEM0250AS4HMA	19,111	LEM0250AS4HVA	20,025	LEM0250AS4HEA	17,782	LEM0250AS4HPA	15,625
LEM0325AS4HMA	21,587	LEM0325AS4HVA	22,956	LEM0325AS4HEA	20,085	LEM0325AS4HPA	16,790
LEM0420AS4HMA	25,609	LEM0420AS4HVA	26,977	LEM0420AS4HEA	23,826	LEM0420AS4HPA	20,564
LEM0490AS4HMA	28,677	LEM0490AS4HVA	30,502	LEM0490AS4HEA	26,683	LEM0490AS4HPA	22,284
LEM0620AS4HMA	31,930	LEM0620AS4HVA	33,753	LEM0620AS4HEA	29,707	LEM0620AS4HPA	25,339

Hot Gas Defrost Base Models - 208-230/1/60

2-Speed EC Motors		VSEC Motors		Fixed Speed EC Motors		PSC Motors		Totally Enclosed PSC Motors	
Base Model	List Price (\$US)	Base Model	List Price (\$US)	Base Model	List Price (\$US)	Base Model	List Price (\$US)	Base Model	List Price (\$US)
	B0000		B0000		B0000		B0000		B0000
LEM0250BS6HMA	15,170	LEM0250BS6HVA	16,083	LEM0250BS6HEA	14,116	LEM0250BS6HPA	11,922	LEM0250BS6HCA	12,815
LEM0300BS6HMA	19,888	LEM0300BS6HVA	20,801	LEM0300BS6HEA	18,506	LEM0300BS6HPA	16,356	LEM0300BS6HCA	17,246
LEM0370BS6HMA	22,523	LEM0370BS6HVA	23,894	LEM0370BS6HEA	20,956	LEM0370BS6HPA	17,667	LEM0370BS6HCA	19,001
LEM0475BS6HMA	26,794	LEM0475BS6HVA	28,163	LEM0475BS6HEA	24,932	LEM0475BS6HPA	21,682	LEM0475BS6HCA	23,014
LEM0595BS6HMA	30,064	LEM0595BS6HVA	31,888	LEM0595BS6HEA	27,971	LEM0595BS6HPA	23,587	LEM0595BS6HCA	25,366
LEM0735BS6HMA	33,422	LEM0735BS6HVA	35,249	LEM0735BS6HEA	31,098	LEM0735BS6HPA	26,746	LEM0735BS6HCA	28,523
LEM0225BS4HMA	14,785	LEM0225BS4HVA	15,697	LEM0225BS4HEA	13,758	LEM0225BS4HPA	11,562	LEM0225BS4HCA	12,451
LEM0250BS4HMA	19,367	LEM0250BS4HVA	20,278	LEM0250BS4HEA	18,019	LEM0250BS4HPA	15,865	LEM0250BS4HCA	16,756
LEM0325BS4HMA	21,954	LEM0325BS4HVA	23,323	LEM0325BS4HEA	20,429	LEM0325BS4HPA	17,133	LEM0325BS4HCA	18,471
LEM0420BS4HMA	25,985	LEM0420BS4HVA	27,352	LEM0420BS4HEA	24,177	LEM0420BS4HPA	20,917	LEM0420BS4HCA	22,254
LEM0490BS4HMA	29,183	LEM0490BS4HVA	31,007	LEM0490BS4HEA	27,154	LEM0490BS4HPA	22,760	LEM0490BS4HCA	24,538
LEM0620BS4HMA	32,437	LEM0620BS4HVA	34,262	LEM0620BS4HEA	30,180	LEM0620BS4HPA	25,817	LEM0620BS4HCA	27,595



HOT GAS DEFROST BASE MODELS

Please consult AWEF and Net Capacity table of Technical bulletin to confirm DOE compliance per model.

Hot Gas Defrost Base Models - 460/1/60

PSC Motors		Totally Enclosed PSC Motors	
Base Model	List Price (\$US)	Base Model	List Price (\$US)
	B0000		B0000
LEM0250MS6HPA	12,881	LEM0250MS6HCA	13,772
LEM0300MS6HPA	17,316	LEM0300MS6HCA	18,203
LEM0370MS6HPA	19,111	LEM0370MS6HCA	20,443
LEM0475MS6HPA	23,148	LEM0475MS6HCA	24,483
LEM0595MS6HPA	25,498	LEM0595MS6HCA	27,276
LEM0735MS6HPA	28,665	LEM0735MS6HCA	30,445
LEM0225MS4HPA	12,515	LEM0225MS4HCA	13,404
LEM0250MS4HPA	16,824	LEM0250MS4HCA	17,712
LEM0325MS4HPA	18,579	LEM0325MS4HCA	19,913
LEM0420MS4HPA	22,394	LEM0420MS4HCA	23,728
LEM0490MS4HPA	24,672	LEM0490MS4HCA	26,451
LEM0620MS4HPA	27,727	LEM0620MS4HCA	29,505

Hot Gas Defrost Base Models - 575/1/60

PSC Motors	
Base Model	List Price (\$US)
	B0000
LEM0250LS6HPA	13,012
LEM0300LS6HPA	17,490
LEM0370LS6HPA	19,303
LEM0475LS6HPA	23,388
LEM0595LS6HPA	25,764
LEM0735LS6HPA	28,958
LEM0225LS4HPA	12,644
LEM0250LS4HPA	16,999
LEM0325LS4HPA	18,769
LEM0420LS4HPA	22,618
LEM0490LS4HPA	24,925
LEM0620LS4HPA	28,014

MEDIUM PROFILE EVAPORATOR



FACTORY INSTALLED: A LA CARTE OPTION PACKAGES

Refer to page 62 for Factory Installed: Preferred Option Packages.

Air Defrost

Larkin Model	Factory Installed: A la Carte Options (List Price Adder US \$)										
	Electrical Options							Mechanical Options			
	intelliGen™	intelliGen Cards			Mech. Room T'stat	Elec. Room T'stat	Adj. Defrost Term./Fan Delay	TXV	TXV & LLSV	TXV & LLSV - SPORLAN	Master TXV and Sporlan LLSV
Webserver Card		Multi-System Control (MSC)	Integration Card								
LEM0185^S8A*B	4,749	1,089	1,500	618	506	783	347	958	1,461	1,461	1,461
LEM0225^S8A*B	4,749	1,089	1,500	618	506	783	347	958	1,461	1,461	1,461
LEM0405^S8A*B	4,749	1,089	1,500	618	506	783	347	958	1,461	1,461	1,461
LEM0475^S8A*B	4,749	1,089	1,500	618	506	783	347	958	1,461	1,461	1,461
LEM0575^S8A*B	4,749	1,089	1,500	618	506	783	347	1,288	2,066	2,066	2,066
LEM0675^S8A*B	4,749	1,089	1,500	618	506	783	347	1,288	2,066	2,066	2,066
LEM0775^S8A*B	4,749	1,089	1,500	618	506	783	347	1,288	2,066	2,066	2,066
LEM0975^S8A*B	4,749	1,089	1,500	618	506	783	347	1,288	2,066	2,066	2,066
LEM1115^S8A*B	4,749	1,089	1,500	618	506	783	347	1,865	2,863	2,863	2,863

^ Voltage (A = 115/1/60, B = 208-230/1/60, M = 460/1/60, L = 575/1/60)

* Motor (M = 2 Speed EC, E = Fixed Speed EC, C = Totally Enclosed PSC, P = PSC, V = VSEC)

Air Defrost

Larkin Model	Factory Installed: A la Carte Options (List Price Adder US \$)												
	Coil Options				Drain Pan Options					Cabinet Options	Defrost Control Options		
	Coated Coil (Black)	Pro-Kote	Bronz-Glow or ElectroFin	Copper Coil	Double Wall Aluminum Stucco Drain Pan	Double Wall Stainless Steel Drain Pan	Stainless Drain Pan, Standard Cabinet	Stainless Steel Drain Pan	Insulated Drain Pan	Stainless Steel Cabinet	Adjustable defrost control	Adjustable defrost control with limit	Export Crating
LEM0185^S8A*B	2,179	1,970	3,035	5,069	151	151	151	151	151	915	277	347	651
LEM0225^S8A*B	2,179	1,970	3,035	5,069	151	151	151	151	151	915	277	347	651
LEM0405^S8A*B	2,844	2,079	4,097	11,066	211	211	211	211	211	1,168	277	347	915
LEM0475^S8A*B	2,844	2,079	4,295	11,066	211	211	211	211	211	1,168	277	347	915
LEM0575^S8A*B	3,367	2,190	5,200	16,838	264	264	264	264	264	1,462	277	347	1,135
LEM0675^S8A*B	3,367	2,190	5,488	16,838	264	264	264	264	264	1,462	277	347	1,135
LEM0775^S8A*B	3,682	2,288	6,303	22,481	343	343	343	343	343	1,746	277	347	1,297
LEM0975^S8A*B	3,682	2,288	6,683	22,481	343	343	343	343	343	1,746	277	347	1,297
LEM1115^S8A*B	4,196	2,347	7,319	25,541	383	383	383	383	383	1,868	277	347	1,424

^ Voltage (A = 115/1/60, B = 208-230/1/60, M = 460/1/60, L = 575/1/60)

* Motor (M = 2 Speed EC, E = Fixed Speed EC, C = Totally Enclosed PSC, P = PSC, V = VSEC)



FACTORY INSTALLED: A LA CARTE OPTION PACKAGES

Refer to page 63 for Factory Installed: Preferred Option Packages.

Electric Defrost

Larkin Model	Factory Installed: A la Carte Options (List Price Adder US \$)										
	Electrical Options							Mechanical Options			
	intelliGen™	intelliGen Cards			Mech. Room T'stat	Elec. Room T'stat	Adj. Defrost Term./Fan Delay	TXV	TXV & LLSV	TXV & LLSV - SPORLAN	Master TXV and Sporlan LLSV
Webserver Card		Multi-System Control (MSC)	Integration Card								
LEM0125^S6E^A	4,749	1,089	1,500	618	506	783	347	958	1,461	1,461	1,461
LEM0135^S6E^A	4,749	1,089	1,500	618	506	783	347	958	1,461	1,461	1,461
LEM0250^S6E^A	4,749	1,089	1,500	618	506	783	347	958	1,461	1,461	1,461
LEM0300^S6E^A	4,749	1,089	1,500	618	506	783	347	958	1,461	1,461	1,461
LEM0370^S6E^A	4,749	1,089	1,500	618	506	783	347	1,288	2,066	2,066	2,066
LEM0475^S6E^A	4,749	1,089	1,500	618	506	783	347	1,288	2,066	2,066	2,066
LEM0595^S6E^A	4,749	1,089	1,500	618	506	783	347	1,288	2,066	2,066	2,066
LEM0735^S6E^A	4,749	1,089	1,500	618	506	783	347	1,288	2,066	2,066	2,066
LEM0850^S6E^A	4,749	1,089	1,500	618	506	783	347	1,865	2,863	2,863	2,863
LEM0125^S4E^A	4,749	1,089	1,500	618	506	783	347	958	1,461	1,461	1,461
LEM0225^S4E^A	4,749	1,089	1,500	618	506	783	347	958	1,461	1,461	1,461
LEM0250^S4E^A	4,749	1,089	1,500	618	506	783	347	958	1,461	1,461	1,461
LEM0325^S4E^A	4,749	1,089	1,500	618	506	783	347	1,288	2,066	2,066	2,066
LEM0420^S4E^A	4,749	1,089	1,500	618	506	783	347	1,288	2,066	2,066	2,066
LEM0490^S4E^A	4,749	1,089	1,500	618	506	783	347	1,288	2,066	2,066	2,066
LEM0620^S4E^A	4,749	1,089	1,500	618	506	783	347	1,288	2,066	2,066	2,066
LEM0720^S4E^A	4,749	1,089	1,500	618	506	783	347	1,865	2,863	2,863	2,863

^ Voltage (B = 208-230/1/60, C = 208-230/3/60, M = 460/1/60, D = 460/3/60, E = 575/3/60)

* Motor (M = 2 Speed EC, E = Fixed Speed EC, C = Totally Enclosed PSC, P = PSC, V = VSEC)

MEDIUM PROFILE EVAPORATOR



FACTORY INSTALLED: A LA CARTE OPTION PACKAGES

Refer to page 63 for Factory Installed: Preferred Option Packages.

Electric Defrost

Larkin Model	Factory Installed: A la Carte Options (List Price Adder US \$)												
	Coil Options				Drain Pan Options						Cabinet Options	Defrost Control Options	
	Coated Coil (Black)	Pro-Kote	Bronz-Glow or ElectroFin	Copper Coil	Double Wall Aluminum Stucco Drain Pan	Double Wall Stainless Steel Drain Pan	Stainless Drain Pan, Standard Cabinet	Stainless Steel Drain Pan	Insulated Drain Pan	Stainless Steel Cabinet	Adjustable defrost control	Adjustable defrost control with limit	Export Crating
LEM0125^S6E^A	NA	NA	3,035	5,069	151	151	151	151	151	915	277	347	651
LEM0135^S6E^A	NA	NA	3,035	5,069	151	151	151	151	151	915	277	347	651
LEM0250^S6E^A	NA	NA	4,097	11,066	211	211	211	211	211	1,168	277	347	915
LEM0300^S6E^A	NA	NA	4,295	11,066	211	211	211	211	211	1,168	277	347	915
LEM0370^S6E^A	NA	NA	5,200	16,838	264	264	264	264	264	1,462	277	347	1,135
LEM0475^S6E^A	NA	NA	5,488	16,838	264	264	264	264	264	1,462	277	347	1,135
LEM0595^S6E^A	NA	NA	6,303	22,481	343	343	343	343	343	1,746	277	347	1,297
LEM0735^S6E^A	NA	NA	6,683	22,481	343	343	343	343	343	1,746	277	347	1,297
LEM0850^S6E^A	NA	NA	7,319	25,541	383	383	383	383	383	1,868	277	347	1,424
LEM0125^S4E^A	NA	NA	3,035	5,069	151	151	151	151	151	915	277	347	651
LEM0225^S4E^A	NA	NA	4,097	11,066	211	211	211	211	211	1,168	277	347	915
LEM0250^S4E^A	NA	NA	4,295	11,066	211	211	211	211	211	1,168	277	347	915
LEM0325^S4E^A	NA	NA	5,200	16,838	264	264	264	264	264	1,462	277	347	1,135
LEM0420^S4E^A	NA	NA	5,488	16,838	264	264	264	264	264	1,462	277	347	1,135
LEM0490^S4E^A	NA	NA	6,303	22,481	343	343	343	343	343	1,746	277	347	1,297
LEM0620^S4E^A	NA	NA	6,683	22,481	343	343	343	343	343	1,746	277	347	1,297
LEM0720^S4E^A	NA	NA	7,319	25,541	383	383	383	383	383	1,868	277	347	1,424

^ Voltage (B = 208-230/1/60, C = 208-230/3/60, M = 460/1/60, D = 460/3/60, E = 575/3/60)
 * Motor (M = 2 Speed EC, E = Fixed Speed EC, C = Totally Enclosed PSC, P = PSC, V = VSEC)



FACTORY INSTALLED: A LA CARTE OPTION PACKAGES

Hot Gas Defrost

Larkin Model	Factory Installed: A la Carte Options (List Price Adder US \$)							
	Electrical Options				Mechanical Options			
	intelliGen™	intelliGen Cards		Adj. Defrost Term./Fan Delay	TXV	TXV & LLSV	TXV & LLSV - SPORLAN	Master TXV and Sporlan LLSV
	Webserver Card	Integration Card						
LEM0250^S6H^A	NA	NA	NA	NA	958	NA	NA	NA
LEM0300^S6H^A	NA	NA	NA	NA	958	NA	NA	NA
LEM0370^S6H^A	NA	NA	NA	NA	1,288	NA	NA	NA
LEM0475^S6H^A	NA	NA	NA	NA	1,288	NA	NA	NA
LEM0595^S6H^A	NA	NA	NA	NA	1,865	NA	NA	NA
LEM0735^S6H^A	NA	NA	NA	NA	1,865	NA	NA	NA
LEM0225^S4H^A	NA	NA	NA	NA	958	NA	NA	NA
LEM0250^S4H^A	NA	NA	NA	NA	958	NA	NA	NA
LEM0325^S4H^A	NA	NA	NA	NA	1,288	NA	NA	NA
LEM0420^S4H^A	NA	NA	NA	NA	1,288	NA	NA	NA
LEM0490^S4H^A	NA	NA	NA	NA	1,865	NA	NA	NA
LEM0620^S4H^A	NA	NA	NA	NA	1,865	NA	NA	NA

^ Voltage (A = 115/1/60, B = 208-230/1/60, M = 460/1/60, L = 575/1/60)

* Motor (M = 2-Speed EC, E = Fixed Speed EC, C = Totally Enclosed PSC, P = PSC, V = VSEC)

Hot Gas Defrost

Larkin Model	Factory Installed: A la Carte Options (List Price Adder US \$)													
	Coil Options				Drain Pan Options						Cabinet Options	Defrost Control Options		
	Coated Coil (Black)	Pro-Kote	Bronz-Glow or ElectroFin	Copper Coil	Hot Gas Loop	Double Wall Aluminum Stucco Drain Pan	Double Wall Stainless Steel Drain Pan	Stainless Drain Pan, Standard Cabinet	Stainless Steel Drain Pan	Insulated Drain Pan	Stainless Steel Cabinet	Adjustable defrost control	Adjustable defrost control with limit	Export Crating
LEM0250^S6H^A	NA	NA	3,863	11,066	1,145	211	211	211	211	211	1,168	std	NA	915
LEM0300^S6H^A	NA	NA	4,097	11,066	1,145	211	211	211	211	211	1,168	std	NA	915
LEM0370^S6H^A	NA	NA	4,855	16,838	1,375	264	264	264	264	264	1,462	std	NA	1,135
LEM0475^S6H^A	NA	NA	5,200	16,838	1,375	264	264	264	264	264	1,462	std	NA	1,135
LEM0595^S6H^A	NA	NA	5,856	22,481	1,606	343	343	343	343	343	1,746	std	NA	1,297
LEM0735^S6H^A	NA	NA	6,303	22,481	1,606	343	343	343	343	343	1,746	std	NA	1,297
LEM0225^S4H^A	NA	NA	3,863	11,066	1,145	211	211	211	211	211	1,168	std	NA	915
LEM0250^S4H^A	NA	NA	4,097	11,066	1,145	211	211	211	211	211	1,168	std	NA	915
LEM0325^S4H^A	NA	NA	4,855	16,838	1,375	264	264	264	264	264	1,462	std	NA	1,135
LEM0420^S4H^A	NA	NA	5,200	16,838	1,375	264	264	264	264	264	1,462	std	NA	1,135
LEM0490^S4H^A	NA	NA	5,856	22,481	1,606	343	343	343	343	343	1,746	std	NA	1,297
LEM0620^S4H^A	NA	NA	6,303	22,481	1,606	343	343	343	343	343	1,746	std	NA	1,297

^ Voltage (A=115/1/60, B = 208-230/1/60, M = 460/1/60, L = 575/1/60)

*Motor (M = 2 Speed EC, E = Fixed Speed EC, C = Totally Enclosed PSC, P = PSC, V = VSEC)

MEDIUM PROFILE EVAPORATOR



SHIPPED-LOOSE ACCESSORIES

A wide range of shipped-loose accessories are available to order. Can't find something? Other options and accessories might be available on a custom order basis. Please contact your local Sales Representative or Account Engineer for assistance.

Part Number	Description	List Price (\$US)	Notes
Room Thermostats			
2891040	Room Thermostat	490	-
28963301	Electronic Room Thermostat	798	-
Air Sock Collars			
89865801	Collar for Air Sock (18" fan)	393	Must be used with wire fan guards. Must order 1 per fan.
Defrost Controls			
4267W	Adjustable Defrost Control/Fan Delay Switch	483	-
21340101	Electric Defrost Timer (60 Hz)	576	-
5505R	30-Amp Contactor	644	Use as fan or heater contactor
5738N	50-Amp Contactor	699	Use Interlink part 2252340
Check Valves			
5890C	7/8" Suction Line Check Valve	372	-
5889C	1 1/8" Suction Line Check Valve	703	-
2933022	1 3/8" Suction Line Check Valve	1,388	-
5731F	1 5/8" Suction Line Check Valve	1,400	-
Drain Line Heaters			
5508Q	6 ft. Drain Line Heater (208-230V, 42 Watts)	247	-
5594P	12 ft. Drain Line Heater (208-230V, 84 Watts)	331	-
5595P	18 ft. Drain Line Heater (208-230V, 126 Watts)	435	-
5596P	36 ft. Drain Line Heater (208-230V, 252 Watts)	492	-
5597P	60 ft. Drain Line Heater (208-230V, 420 Watts)	885	-
Heat Exchangers			
24200005	Heat Exchanger used on 0185 Air Defrost Model	448	3/8" Liquid Connection OD, 7/8" Suction Connection OD, 14" Length, 2 lb Approx. Ship Wt.
24200006	Heat Exchanger used on 0225 Air Defrost Model, 0125 (6 FPI) & 0125 (4 FPI) Electric Models	467	1/2" Liquid Connection OD, 7/8" Suction Connection OD, 11" Length, 2 lb Approx. Ship Wt.
24200007	Heat Exchanger used on 0135 Electric Defrost Model	523	1/2" Liquid Connection OD, 1-1/8" Suction Connection OD, 14" Length, 2 lb Approx. Ship Wt.
24200008	Heat Exchanger used on 0405-0675 Air Defrost Models, 0250-0300 (6 FPI) Electric & Hot Gas Models, 0225-0250 (4 FPI) Electric Defrost Models	852	5/8" Liquid Connection OD, 1-3/8" Suction Connection OD, 14" Length, 3 lb Approx. Ship Wt.
24200009	Heat Exchanger used on 0775-1115 Air Defrost Models, 0370-0850 (6 FPI) Electric & Hot Gas Models, 0325-0720 (4 FPI) Electric Defrost Models	960	7/8" Liquid Connection OD, 1-5/8" Suction Connection OD, 16" Length, 4 lb Approx. Ship Wt.

Notes:

1. Selections made from matching suction connections of unit cooler to heat exchanger and then matching the hp
2. Low temperature models sized for -20F SST, 10F SCT @ 95F ambient, 5F sub cooling, R404A. Except, LUC has been sized for R448A
3. Medium temperature models sized for 25F SST, 20F SCT @ 95F ambient, 5F sub cooling, R404A. Except, LUC has been sized for R448A



SHIPPED-LOOSE ACCESSORIES

When placing order, please specify refrigerant type, saturated suction temperature (SST), liquid temperature, and room temperature.

Part Number	List Price (\$US)	Size
Liquid-line Solenoid Valves (LLSV)		
29318018	209	3/8
29318019	198	3/8
29318011	589	3/8
5765Y	576	1/2

Liquid Solenoid Valves

Part Number	List Price (\$US)	Size	Capacity Range			
			R404A/R507		R407A/R407C/R407F/R448A/R449A	
			Medium Temperature (BTUH) (25F SST, 95F Liquid)	Low Temperature (BTUH) (-20F SST, 95F Liquid)	Medium Temperature (BTUH) (25F SST, 95F Liquid)	Low Temperature (BTUH) (-20F SST, 95F Liquid)
Liquid-line Solenoid Valves (LLSV)						
29318018	209	3/8	11,000 BTUH and under	10,000 BTUH and under	15,000 BTUH and under	14,000 BTUH and under
29318019	198	3/8	11,000 BTUH to 20,000 BTUH	10,000 BTUH to 18,000 BTUH	15,000 BTUH to 28,000 BTUH	14,000 BTUH to 25,000 BTUH
29318011	589	3/8	20,000 BTUH to 37,000 BTUH	18,000 BTUH to 33,000 BTUH	28,000 BTUH to 49,000 BTUH	25,000 BTUH to 46,000 BTUH
5765Y	576	1/2	22,000 BTUH to 37,000 BTUH	20,000 BTUH to 33,000 BTUH	30,000 BTUH to 50,000 BTUH	27,000 BTUH to 46,000 BTUH
5766Y	589	1/2	37,000 BTUH to 65,000 BTUH	33,000 BTUH to 58,000 BTUH	50,000 BTUH to 88,000 BTUH	46,000 BTUH to 80,000 BTUH
5768Y	782	5/8	65,000 BTUH to 121,000 BTUH	58,000 BTUH to 107,000 BTUH	88,000 BTUH to 163,000 BTUH	80,000 BTUH to 149,000 BTUH

Notes:

1. Selections made from matching suction connections of unit cooler to heat exchanger and then matching the hp
 2. Low temperature models sized for -20F SST, 10F SCT @ 95F ambient, 5F sub cooling, R404A. Except, LUC has been sized for R448A
 3. Medium temperature models sized for 25F SST, 20F SCT @ 95F ambient, 5F sub cooling, R404A. Except, LUC has been sized for R448A
- When placing order, please specify refrigerant type, saturated suction temperature (SST), liquid temperature, and room temperature.

MEDIUM PROFILE EVAPORATOR



intelliGen™ SERVICE PARTS

Part Number	Description	List Price (US \$)
Field Mount Kit		
59755002	intelliGen Field Mount (iFM) Kit with 25ft sensor lead wires	\$2,600
Power Harness		
22699903	15ft harness for power, fan, defrost heater, solenoid valve	\$500
22699902	25ft harness for power, fan, defrost heater, solenoid valve	\$830
22699901	40ft harness for power, fan, defrost heater, solenoid valve	\$1,230
Temperature Sensors		
89904903	Temperature Sensor Kit - White Leads, 3ft	\$79
59755302	15ft sensor kit (3 temperature sensors, 1 pressure transducer harness)	\$270
59755301	40ft sensor kit (3 temperature sensors, 1 pressure transducer harness)	\$390
Pressure Transducer & Harnesses		
28911202	Pressure Transducer 0 - 300 PSIA	\$367
22515107	Pressure Transducer Harness, 15ft	\$110
22515105	Pressure Transducer Harness, 40ft	\$190
Transformers		
22529601	Transformer 120/24 volt - 40 VA	\$116
22529602	Transformer 240/24 volt - 40 VA	\$117
22529603	Transformer 460/24 - 40 VA	\$143
22529701	Transformer 575/24 - 40 VA	\$197
Electronic Expansion Valve (EXV) & Cables		
29326101	Carel EXV E2V11FWAE0 - 3/8" x 3/8" Conn	\$1,263
29326201	Carel EXV E2V24FWAE0 - 3/8" x 3/8" Conn	\$1,263
29326401	Carel EXV E2V24FSME0 - 5/8" X 5/8" Conn	\$1,263
29326501	Carel EXV E3V45ASTE0 - 7/8" X 1 3/8" Conn	\$2,481
29326601	Carel EXV E3V55ASTE0 - 7/8" X 1 3/8" Conn	\$2,481
22592201	Cable for Carel EXV, 10ft	\$150
22592103	Cable for Carel EXV, 25ft	\$260
22592102	Cable for Carel EXV, 40ft	\$320
Control Boards		
28918001S	iRC Main Control Board Replacement Kit	\$1,288
28918201S	iRCUI User Interface Replacement Kit	\$871
28918301S	iWC Webserver Card Replacement Kit	\$1,141
28918302S	Multi-system Control with Lead-lag (MSC) Card Field Mount Kit	\$1,575
28918401S	iIC Integration Card Replacement Kit	\$660
UI to iRC Ribbon Cables		
22602104	For Medium Profile and Large Unit Cooler, 24" Replacement Kit	\$481
Door Switch		
22543102	Door Switch Kit (includes door switch and 2 ft cable)	\$296

MEDIUM PROFILE EVAPORATOR



intelliGen™ SERVICE PARTS

Part Number	Defrost Type	Voltage/Phase	Models	Color Finish	List Price (US \$)
intelliGen Retrofit Kits for Beacon II and QRC Controls					
89730301	Air Defrost	115-230/1	All	Stucco	\$2,300
89730302				White	\$2,300
89730303		460/1		Stucco	\$2,300
89730304				White	\$2,300
89730305	Electric Defrost	208-230/3	All	Stucco	\$2,300
89730306				White	\$2,300
89730307		208-230/3 with >30A Heater ¹		Stucco	\$2,300
89730308				White	\$2,300
89730309		460/3		Stucco	\$2,300
89730310				White	\$2,300

Note:

1. Medium Profile unit coolers have greater than 30 Amp draw with large defrost heaters use kit part number 89730307 and 89730308. intelliGen Field Mount (IFM) kit could be used for these models. Ask Heatcraft sales representatives for details.



HOT GAS REVERSE CYCLE KITS

Kits for Models with Standard Electric Pan

Hot Gas Models Used On:	Factory-Installed	Shipped-Loose	
	List Price Adder (\$US)	Part Number	List Price (\$US)
BEM0250^S6H^A	4,282	89867601	638
BEM0300^S6H^A	4,282	89867601	638
BEM0370^S6H^A	4,736	89867602	935
BEM0475^S6H^A	4,736	89867602	935
BEM0595^S6H^A	4,736	89867602	935
BEM0735^S6H^A	4,736	89867602	935
BEM0225^S4H^A	4,282	89867601	638
BEM0250^S4H^A	4,282	89867601	638
BEM0325^S4H^A	4,736	89867602	935
BEM0420^S4H^A	4,736	89867602	935
BEM0490^S4H^A	4,736	89867602	935
BEM0620^S4H^A	4,736	89867602	935

^ = Voltage (A = 115/1/60, B = 208-230/1/60, M = 460/1/60, L = 575/1/60)

* = Motor (M = 2 Speed EC, E = Fixed Speed EC, V = VSEC, P = PSC, C = Totally Enclosed PSC)

Notes:

- Factory-installed kits include expansion valve and TXV bypass check valve assembly. Specify valve model style, refrigerant, and SST at time of order.
- Shipped-loose kits include one check valve and piping for TXV bypass around expansion valve. Kit does not include expansion valve.

Kits for Models with Standard Electric Pan

Hot Gas Models Used On:	Factory-Installed	Shipped-Loose	
	List Price Adder (\$US)	Part Number	List Price (\$US)
BEM0250^S6H^A	5,591	89869403 + 89867601	1,745
BEM0300^S6H^A	6,582	89869402 + 89867601	2,146
BEM0370^S6H^A	7,036	89869402 + 89867602	2,443
BEM0475^S6H^A	7,036	89869402 + 89867602	2,443
BEM0595^S6H^A	7,297	89869401 + 89867602	2,610
BEM0735^S6H^A	7,297	89869401 + 89867602	2,610
BEM0225^S4H^A	5,591	89869403 + 89867601	1,745
BEM0250^S4H^A	6,582	89869402 + 89867601	2,146
BEM0325^S4H^A	7,036	89869402 + 89867602	2,443
BEM0420^S4H^A	7,036	89869402 + 89867602	2,443
BEM0490^S4H^A	7,297	89869401 + 89867602	2,610
BEM0620^S4H^A	7,297	89869401 + 89867602	2,610

^ = Voltage (A = 115/1/60, B = 208-230/1/60, M = 460/1/60, L = 575/1/60)

* = Motor (M = 2 Speed EC, E = Fixed Speed EC, V = VSEC, P = PSC, C = Totally Enclosed PSC)

Notes:

- Factory installed kits include expansion valve, TXV Bypass check valve assembly, suction check valve assembly, and drain pan check valve assembly. Kit does not include hot gas pan price. Specify valve model style, refrigerant, and SST at time of order.
- Shipped-loose kits include one check valve and piping for TXV bypass around expansion valve, one check valve and piping for drain pan assembly and one check valve and piping for suction assembly. Kit does not include hot gas pan pricing. Kit does not include expansion valve.



LARGE UNIT COOLER EVAPORATOR

NOMENCLATURE

Table 1 - 24" Fan DOE Compliant and Non-compliant Models

BTU CAPACITY		APPLICATION	DEFROST STYLE	VINTAGE
MODELS MEET MINIMUM AWEF*	MODELS DO NOT MEET MINIMUM AWEF**			
0480 = 48,000	0373 = 40,150	S = Standard Refrigerants C = CO ₂ ⁺ G = Glycol [†]	A = Air Defrost E = Electric Defrost H = Hot Gas Defrost	
0540 = 53,800	0423 = 45,000			
0565 = 56,400	0473 = 50,100			
0630 = 63,000	0513 = 55,250			
0700 = 69,800	...			
0730 = 72,700				
...				

PRODUCT IDENTIFIER	EVAPORATOR STYLE	VOLTAGE	FINS PER INCH (FPI)	MOTOR TYPE	FACTORY-INSTALLED OPTION PACKAGES
E = Evaporator	H = LUC (Large Unit Cooler)	B = 208-230/1/60 C = 208-230/3/60 D = 460/3/60 M = 460/1/60 E = 575/3/60 X = 380-400/3/50	6 4	M = 2-Speed EC T = 3 Phase AC Totally Enclosed Rail Mount Y = 3 Phase AC Open Drip Proof Rail Mount P = PSC Open Drip Proof Rail Mount H = High CFM Rail Mount V = Variable speed	B#### = Preferred Option Packages D#### = A la Carte Options Y#### = Custom Option Packages

L E H 0630 C S 6 A M A B0000

BRAND	EVAPORATOR STYLE	VOLTAGE	FINS PER INCH (FPI)	MOTOR TYPE	FACTORY-INSTALLED OPTION PACKAGES
L = Larkin	H = LUC (Large Unit Cooler)	B = 208-230/1/60 C = 208-230/3/60 D = 460/3/60 M = 460/1/60 E = 575/3/60 X = 380-400/3/50	6 4	M = 2-Speed EC T = 3 Phase AC Totally Enclosed Rail Mount Y = 3 Phase AC Open Drip Proof Rail Mount P = PSC Open Drip Proof Rail Mount H = High CFM Rail Mount V = Variable speed	B#### = Preferred Option Packages D#### = A la Carte Options Y#### = Custom Option Packages

* Models meet minimum AWEF have a model capacity digit that ends with "0" or "5".
 ** Models do not meet minimum AWEF have a model capacity digit ending with "3"
 † Call for Glycol and CO₂ models, special process required.

FEATURES & BENEFITS

GENERAL FEATURES

- Mill finish aluminum provides an attractive design and structurally sound cabinet
- Thermo-Flex (with five-year limited warranty) is innovative, eliminates leaks, and reduces risk of refrigerant loss
- Liquid line solenoid wiring harness for faster installation
- Suction Schrader fitting for easier suction temperature measurement
- Hinged drain pan and access panels for easy servicing
- Adjustable defrost control can be customized per application
- Long air throw is ideal for large warehouse and industrial applications
- Standardized terminal board for easier field wiring
- Improved wire management and routing for easier installation and service
- Complete hot gas defrost model offering meets more applications
- Quick reference QR code providing access to relevant product documentation.

DOE 2020 COMPLIANT MODEL ADDITIONAL FEATURES

- 2-Speed EC motor, totally enclosed
- 850 RPM low noise motor
- Balanced heater load for electric defrost
- Air defrost terminal block

OPTIONS

- High CFM motor and fan combinations (208-230/3/60 and 460/3/60) *
- Totally enclosed motors (208-230/3/60 and 460/3/60)
- Low temperature motors for blast cooling and freezing (for room temps -31°F to -50°F) *
- Units available with Bronze-Glow coil coating (air, electric and hot gas)
- Units available with copper fins (6 FPI models only)
- Air defrost units available with polyester coated fins or various coil coating options
- Long air throw collars for large warehouse and industrial applications
- Insulated drain pan
- Factory installed mounted components are available in these configurations:
 - Pre-assembled units come with mounted TXV, liquid line solenoid valve and room thermostat
 - Mounted TXV
 - Mounted TXV and solenoid valve
 - Mounted room thermostat
- Defrost termination control (Electric and Hot Gas Defrost models)
- Mounted fusing for motors and heaters
- More factory mounted features for easier field installation available, consult factory for details

OUTSTANDING FEATURES

2-Speed EC motor

improves efficiency and provides more energy savings



Hinged Access Panels

allow for easy access to components

Balance Heater Load

improves reliability and generates more energy savings

Hinged Drain Pan

improves access to service and clean the drain pan and coil



PREFERRED OPTION PACKAGES

Heatcraft now offers pre-defined kits that represent frequently ordered options or combinations of options. The preferred kits make it easier for customers to configure their units and may provide a savings over factory installed a la carte option selections.

Bundle options and save!

5% discount on bundled options selected over same A la Carte Options

Refer page 121 for A la Carte Options.

Preferred Options	
Control Options	
B0000	Standard Base
B0250	Standard base + intelliGen (R-404A)
B0251	Standard base + intelliGen (R-448A/R-449A)
B0252	Standard base + intelliGen (R-407A/F)
B0253	Standard base + intelliGen (R-407C)
Mounted Components Options	
B0450	Standard base + Mounted TXV (R-404A)
B0451	Standard base + Mounted TXV + Solenoid (R-404A)
B0453	Standard base + Mounted TXV (R-407A/F)
B0454	Standard base + Mounted TXV + Solenoid (R-407A/F)
B0456	Standard base + Mounted TXV (R-448A/R-449A)
B0457	Standard base + Mounted TXV + Solenoid (R-448A/R-449A)
B0459	Standard base + Mounted TXV (R-407C)
B0460	Standard base + Mounted TXV + Solenoid (R-407C)

Example:

BASE MODEL 55,300 BTU Air Defrost (BEH0553CS6AMA) \$25,368	+	B0251 [Standard Base + intelliGen (R-448A/R-449A)] = \$7,658	=	\$33,026
		intelliGen™ (R-448A/R-449A) = \$8,061		\$33,429



PREFERRED OPTION PACKAGES

Standard Base +											
intelliGen™				TXV				TXV + Solenoid			
R-404A	R-448A/R-449A	R-407A/F	R-407C	R-404A	R-448A/R-449A	R-407A/F	R-407C	R-404A	R-448A/R-449A	R-407A/F	R-407C
B0250	B0251	B0252	B0253	B0450	B0453	B0456	B0459	B0451	B0454	B0457	B0460

AIR DEFROST PREFERRED MODELS

Air Defrost Models with 2-Speed EC Motor - 208-230/3/60

Base Model	# of Fans	Fan Size (Inch)	List Price (\$US)			
			B0000	B0250, B0251, B0252, B0253	B0450, B0453, B0456, B0459	B0451, B0454, B0457, B0460
LEH0553CS6AMA	2	24"	26,129	34,017	27,756	28,660
LEH0570CS6AMA	2	24"	25,535	33,423	27,162	28,066
LEH0700CS6AMA	2	24"	27,941	35,829	29,568	30,472
LEH0723CS6AMA	2	24"	28,527	36,415	30,154	31,058
LEH0743CS6AMA	3	24"	33,416	41,304	35,043	35,947
LEH0755CS6AMA	2	24"	31,038	38,926	32,665	33,569
LEH0900CS6AMA	3	24"	35,158	43,046	36,785	37,689
LEH0933CS6AMA	3	24"	35,466	43,354	37,093	37,997
LEH1053CS6AMA	4	24"	38,227	46,115	40,156	41,284
LEH1080CS6AMA	3	24"	37,638	45,526	39,265	40,169
LEH1245CS6AMA	3	24"	40,744	48,632	42,371	43,275
LEH1313CS6AMA	4	24"	41,156	49,044	43,085	44,213
LEH1445CS6AMA	4	24"	43,854	51,742	45,783	46,911
LEH1655CS6AMA	4	24"	48,116	56,004	50,045	51,173
LEH0620CS6AMA	1	30"	26,755	34,643	29,136	30,124
LEH0730CS6AMA	1	30"	28,127	36,015	30,238	31,496
LEH0840CS8AMA	1	30"	30,811	38,699	32,922	34,180
LEH1250CS6AMA	2	30"	40,962	48,850	43,343	44,331
LEH1470CS6AMA	2	30"	46,071	53,959	48,182	49,440
LEH1870CS6AMA	3	30"	60,317	68,205	63,077	64,222
LEH2200CS6AMA	3	30"	71,059	78,947	73,299	74,633
LEH1333CS6AMA	3	30"	50,848	58,736	52,777	53,905
LEH1623CS6AMA	3	30"	57,158	65,046	59,087	60,215
LEH1873CS6AMA	3	30"	60,317	68,205	62,698	63,686
LEH2203CS6AMA	3	30"	71,059	78,947	73,170	74,428
LEH2553CS6AMA	4	30"	77,051	84,939	79,162	80,420
LEH2883CS6AMA	4	30"	89,368	Call	91,479	92,737
LEH2513CS8AMA	3	30"	78,631	86,519	80,742	82,000
LEH2953CS8AMA	4	30"	86,839	Call	88,950	90,208
LEH3283CS8AMA	4	30"	93,467	Call	95,578	96,836



PREFERRED OPTION PACKAGES

Standard Base +											
intelliGen™				TXV				TXV + Solenoid			
R-404A	R-448A/R-449A	R-407A/F	R-407C	R-404A	R-448A/R-449A	R-407A/F	R-407C	R-404A	R-448A/R-449A	R-407A/F	R-407C
B0250	B0251	B0252	B0253	B0450	B0453	B0456	B0459	B0451	B0454	B0457	B0460

AIR DEFROST PREFERRED MODELS

Air Defrost Models with 2-Speed EC Motor - 460/3/60

Base Model	# of Fans	Fan Size (Inch)	List Price (\$US)			
			B0000	B0250, B0251, B0252, B0253	B0450, B0453, B0456, B0459	B0451, B0454, B0457, B0460
LEH0553DS6AMA	2	24"	26,129	34,017	27,756	28,660
LEH0570DS6AMA	2	24"	26,287	34,175	27,914	28,818
LEH0700DS6AMA	2	24"	29,467	37,355	31,094	31,998
LEH0723DS6AMA	2	24"	28,527	36,415	30,154	31,058
LEH0743DS6AMA	3	24"	33,416	41,304	35,043	35,947
LEH0755DS6AMA	2	24"	32,297	40,185	33,924	34,828
LEH0900DS6AMA	3	24"	35,779	43,667	37,406	38,310
LEH0933DS6AMA	3	24"	35,466	43,354	37,093	37,997
LEH1053DS6AMA	4	24"	38,227	46,115	40,156	41,284
LEH1080DS6AMA	3	24"	40,319	48,207	41,946	42,850
LEH1245DS6AMA	3	24"	43,309	51,197	44,936	45,840
LEH1313DS6AMA	4	24"	41,156	49,044	43,085	44,213
LEH1445DS6AMA	4	24"	46,071	53,959	48,000	49,128
LEH1655DS6AMA	4	24"	51,614	59,502	53,543	54,671
LEH0620DS6AMA	1	30"	27,293	35,181	29,674	30,662
LEH0730DS6AMA	1	30"	28,691	36,579	30,802	32,060
LEH0840DS8AMA	1	30"	31,428	39,316	33,539	34,797
LEH1250DS6AMA	2	30"	41,781	49,669	44,162	45,150
LEH1470DS6AMA	2	30"	46,995	54,883	49,106	50,364
LEH1870DS6AMA	3	30"	61,330	69,218	64,090	65,235
LEH2200DS6AMA	3	30"	72,253	80,141	74,493	75,827
LEH1333DS6AMA	3	30"	51,703	59,591	53,632	54,760
LEH1623DS6AMA	3	30"	58,121	66,009	60,050	61,178
LEH1873DS6AMA	3	30"	61,330	69,218	63,711	64,699
LEH2203DS6AMA	3	30"	72,253	80,141	74,364	75,622
LEH2553DS6AMA	4	30"	78,348	86,236	80,459	81,717
LEH2883DS6AMA	4	30"	90,872	Call	92,983	94,241
LEH2513DS8AMA	3	30"	79,954	87,842	82,065	83,323
LEH2953DS8AMA	4	30"	88,299	Call	90,410	91,668
LEH3283DS8AMA	4	30"	95,038	Call	97,149	98,407



PREFERRED OPTION PACKAGES

intelliGen™				Standard Base +				TXV + Solenoid			
R-404A	R-448A/R-449A	R-407A/F	R-407C	R-404A	R-448A/R-449A	R-407A/F	R-407C	R-404A	R-448A/R-449A	R-407A/F	R-407C
B0250	B0251	B0252	B0253	B0450	B0453	B0456	B0459	B0451	B0454	B0457	B0460

AIR DEFROST PREFERRED MODELS

Air Defrost Models with PSC Open Drip Proof Rail Mount Motors - 208-230/1/60

Base Model	# of Fans	Fan Size (Inch)	List Price (\$US)			
			B0000	B0250, B0251, B0252, B0253	B0450, B0453, B0456, B0459	B0451, B0454, B0457, B0460
LEH0553BS6APA	2	24"	19,949	27,837	21,576	22,480
LEH0723BS6APA	2	24"	22,089	29,977	23,716	24,620
LEH0743BS6APA	3	24"	26,658	34,546	28,285	29,189
LEH0933BS6APA	3	24"	28,807	36,695	30,434	31,338
LEH1053BS6APA	4	24"	30,959	38,847	32,888	34,016
LEH1313BS6APA	4	24"	33,910	41,798	35,839	36,967

Air Defrost Models with PSC Open Drip Proof Rail Mount Motors - 460/1/60

Base Model	# of Fans	Fan Size (Inch)	List Price (\$US)			
			B0000	B0250, B0251, B0252, B0253	B0450, B0453, B0456, B0459	B0451, B0454, B0457, B0460
LEH0553MS6APA	2	24"	19,949	27,837	21,576	22,480
LEH0723MS6APA	2	24"	22,089	29,977	23,716	24,620
LEH0743MS6APA	3	24"	19,949	27,837	21,576	22,480
LEH0933MS6APA	3	24"	28,807	36,695	30,434	31,338
LEH1053MS6APA	4	24"	30,959	38,847	32,888	34,016
LEH1313MS6APA	4	24"	33,910	41,798	35,839	36,967

Air Defrost Models with 3 Phase AC Open Drip Proof Rail Mount Motors - 208-230/3/60

Base Model	# of Fans	Fan Size (Inch)	List Price (\$US)			
			B0000	B0250, B0251, B0252, B0253	B0450, B0453, B0456, B0459	B0451, B0454, B0457, B0460
LEH0553CS6AYA	2	24"	21,152	29,040	22,779	23,683
LEH0723CS6AYA	2	24"	23,575	31,463	25,202	26,106
LEH0743CS6AYA	3	24"	28,515	36,403	30,142	31,046
LEH0933CS6AYA	3	24"	30,583	38,471	32,210	33,114
LEH1053CS6AYA	4	24"	33,369	41,257	35,298	36,426
LEH1313CS6AYA	4	24"	36,321	44,209	38,250	39,378
LEH1333CS6AYA	3	30"	43,240	51,128	45,169	46,297
LEH1623CS6AYA	3	30"	48,607	56,495	50,536	51,664
LEH1873CS6AYA	3	30"	51,292	59,180	53,673	54,661
LEH2203CS6AYA	3	30"	60,427	68,315	62,538	63,796
LEH2553CS6AYA	4	30"	65,523	73,411	67,634	68,892
LEH2883CS6AYA	4	30"	75,998	Call	78,109	79,367
LEH2513CS8AYA	3	30"	66,867	74,755	68,978	70,236
LEH2953CS8AYA	4	30"	73,847	Call	75,958	77,216
LEH3283CS8AYA	4	30"	79,483	Call	81,594	82,852



PREFERRED OPTION PACKAGES

intelliGen™				Standard Base +				TXV + Solenoid			
R-404A	R-448A/R-449A	R-407A/F	R-407C	R-404A	R-448A/R-449A	R-407A/F	R-407C	R-404A	R-448A/R-449A	R-407A/F	R-407C
B0250	B0251	B0252	B0253	B0450	B0453	B0456	B0459	B0451	B0454	B0457	B0460

AIR DEFROST PREFERRED MODELS

Air Defrost Models with 3 Phase AC Open Drip Proof Rail Mount Motors - 380-400/3/50

Base Model	# of Fans	Fan Size (Inch)	List Price (\$US)			
			B0000	B0250, B0251, B0252, B0253	B0450, B0453, B0456, B0459	B0451, B0454, B0457, B0460
LEH0553XS6AYA	2	24"	21,152	29,040	22,779	23,683
LEH0723XS6AYA	2	24"	23,575	31,463	25,202	26,106
LEH0743XS6AYA	3	24"	28,515	36,403	30,142	31,046
LEH0933XS6AYA	3	24"	30,583	38,471	32,210	33,114
LEH1053XS6AYA	4	24"	33,369	41,257	35,298	36,426
LEH1313XS6AYA	4	24"	36,326	44,214	38,255	39,383
LEH1873XS6AYA	3	30"	51,292	59,180	53,673	54,661
LEH2203XS6AYA	3	30"	60,427	68,315	62,538	63,796
LEH2553XS6AYA	4	30"	65,523	73,411	67,634	68,892
LEH2883XS6AYA	4	30"	75,998	Call	78,109	79,367
LEH2513XS8AYA	3	30"	66,867	74,755	68,978	70,236
LEH2953XS8AYA	4	30"	73,847	Call	75,958	77,216
LEH3283XS8AYA	4	30"	79,483	Call	81,594	82,852

Air Defrost Models with 3 Phase AC Open Drip Proof Rail Mount Motors - 460/3/60

Base Model	# of Fans	Fan Size (Inch)	List Price (\$US)			
			B0000	B0250, B0251, B0252, B0253	B0450, B0453, B0456, B0459	B0451, B0454, B0457, B0460
LEH0553DS6AYA	2	24"	21,152	29,040	22,779	23,683
LEH0723DS6AYA	2	24"	23,575	31,463	25,202	26,106
LEH0743DS6AYA	3	24"	28,515	36,403	30,142	31,046
LEH0933DS6AYA	3	24"	30,583	38,471	32,210	33,114
LEH1053DS6AYA	4	24"	33,369	41,257	35,298	36,426
LEH1313DS6AYA	4	24"	36,326	44,214	38,255	39,383
LEH1333DS6AYA	3	30"	43,240	51,128	45,169	46,297
LEH1623DS6AYA	3	30"	48,607	56,495	50,536	51,664
LEH1873DS6AYA	3	30"	51,292	59,180	53,673	54,661
LEH2203DS6AYA	3	30"	60,427	68,315	62,538	63,796
LEH2553DS6AYA	4	30"	65,523	73,411	67,634	68,892
LEH2883DS6AYA	4	30"	75,998	Call	78,109	79,367
LEH2513DS8AYA	3	30"	66,867	74,755	68,978	70,236
LEH2953DS8AYA	4	30"	73,847	Call	75,958	77,216
LEH3283DS8AYA	4	30"	79,483	Call	81,594	82,852



PREFERRED OPTION PACKAGES

intelliGen™				Standard Base +				TXV + Solenoid			
R-404A	R-448A/R-449A	R-407A/F	R-407C	TXV				TXV + Solenoid			
B0250	B0251	B0252	B0253	R-404A	R-448A/R-449A	R-407A/F	R-407C	R-404A	R-448A/R-449A	R-407A/F	R-407C
B0250	B0251	B0252	B0253	B0450	B0453	B0456	B0459	B0451	B0454	B0457	B0460

AIR DEFROST PREFERRED MODELS

Air Defrost Models with 3 Phase AC Open Drip Proof Rail Mount Motors - 575/3/60

Base Model	# of Fans	Fan Size (Inch)	List Price (\$US)			
			B0000	B0250, B0251, B0252, B0253	B0450, B0453, B0456, B0459	B0451, B0454, B0457, B0460
LEH1333ES6AYA	3	30"	44,102	51,990	46,031	47,159
LEH1623ES6AYA	3	30"	49,577	57,465	51,506	52,634
LEH1873ES6AYA	3	30"	52,317	60,205	54,698	55,686
LEH2553ES6AYA	4	30"	66,834	74,722	68,945	70,203
LEH2953ES8AYA	4	30"	75,326	Call	77,437	78,695

Air Defrost Models with 3 Phase AC Totally Enclosed Rail Mount Motors - 208-230/3/60

Base Model	# of Fans	Fan Size (Inch)	List Price (\$US)			
			B0000	B0250, B0251, B0252, B0253	B0450, B0453, B0456, B0459	B0451, B0454, B0457, B0460
LEH0553CS6ATA	2	24"	21,509	29,397	23,136	24,040
LEH0723CS6ATA	2	24"	23,650	31,538	25,277	26,181
LEH0743CS6ATA	3	24"	28,997	36,885	30,624	31,528
LEH0933CS6ATA	3	24"	31,144	39,032	32,771	33,675
LEH1053CS6ATA	4	24"	34,077	41,965	36,006	37,134
LEH1313CS6ATA	4	24"	37,027	44,915	38,956	40,084
LEH1333CS6ATA	3	30"	44,593	52,481	46,522	47,650
LEH1623CS6ATA	3	30"	49,960	57,848	51,889	53,017
LEH1873CS6ATA	3	30"	52,645	60,533	55,026	56,014
LEH2203CS6ATA	3	30"	61,780	69,668	63,891	65,149
LEH2553CS6ATA	4	30"	67,327	75,215	69,438	70,696
LEH2883CS6ATA	4	30"	77,801	Call	79,912	81,170
LEH2513CS8ATA	3	30"	68,219	76,107	70,330	71,588
LEH2953CS8ATA	4	30"	75,650	Call	77,761	79,019
LEH3283CS8ATA	4	30"	81,287	Call	83,398	84,656



PREFERRED OPTION PACKAGES

intelliGen™				Standard Base +				TXV + Solenoid			
R-404A	R-448A/R-449A	R-407A/F	R-407C	R-404A	R-448A/R-449A	R-407A/F	R-407C	R-404A	R-448A/R-449A	R-407A/F	R-407C
B0250	B0251	B0252	B0253	B0450	B0453	B0456	B0459	B0451	B0454	B0457	B0460

AIR DEFROST PREFERRED MODELS

Air Defrost Models with 3 Phase AC Totally Enclosed Rail Mount Motors - 380-400/3/50

Base Model	# of Fans	Fan Size (Inch)	List Price (\$US)			
			B0000	B0250, B0251, B0252, B0253	B0450, B0453, B0456, B0459	B0451, B0454, B0457, B0460
LEH0553XS6ATA	2	24"	21,509	29,397	23,136	24,040
LEH0723XS6ATA	2	24"	23,650	31,538	25,277	26,181
LEH0743XS6ATA	3	24"	28,997	36,885	30,624	31,528
LEH0933XS6ATA	3	24"	31,144	39,032	32,771	33,675
LEH1053XS6ATA	4	24"	34,077	41,965	36,006	37,134
LEH1313XS6ATA	4	24"	37,027	44,915	38,956	40,084
LEH1333XS6ATA	3	30"	44,593	52,481	46,522	47,650
LEH1623XS6ATA	3	30"	49,960	57,848	51,889	53,017
LEH1873XS6ATA	3	30"	52,645	60,533	55,026	56,014
LEH2203XS6ATA	3	30"	61,780	69,668	63,891	65,149
LEH2553XS6ATA	4	30"	67,327	75,215	69,438	70,696
LEH2883XS6ATA	4	30"	77,801	Call	79,912	81,170
LEH2513XS8ATA	3	30"	68,219	76,107	70,330	71,588
LEH2953XS8ATA	4	30"	75,650	Call	77,761	79,019
LEH3283XS8ATA	4	30"	81,287	Call	83,398	84,656

Air Defrost Models with 3 Phase AC Totally Enclosed Rail Mount Motors - 460/3/60

Base Model	# of Fans	Fan Size (Inch)	List Price (\$US)			
			B0000	B0250, B0251, B0252, B0253	B0450, B0453, B0456, B0459	B0451, B0454, B0457, B0460
LEH0553DS6ATA	2	24"	21,509	29,397	23,136	24,040
LEH0723DS6ATA	2	24"	23,650	31,538	25,277	26,181
LEH0743DS6ATA	3	24"	28,997	36,885	30,624	31,528
LEH0933DS6ATA	3	24"	31,144	39,032	32,771	33,675
LEH1053DS6ATA	4	24"	34,077	41,965	36,006	37,134
LEH1313DS6ATA	4	24"	37,027	44,915	38,956	40,084
LEH1333DS6ATA	3	30"	44,593	52,481	46,522	47,650
LEH1623DS6ATA	3	30"	49,960	57,848	51,889	53,017
LEH1873DS6ATA	3	30"	52,645	60,533	55,026	56,014
LEH2203DS6ATA	3	30"	61,780	69,668	63,891	65,149
LEH2553DS6ATA	4	30"	67,327	75,215	69,438	70,696
LEH2883DS6ATA	4	30"	77,801	Call	79,912	81,170
LEH2513DS8ATA	3	30"	68,219	76,107	70,330	71,588
LEH2953DS8ATA	4	30"	75,650	Call	77,761	79,019
LEH3283DS8ATA	4	30"	81,287	Call	83,398	84,656



PREFERRED OPTION PACKAGES

intelliGen™				Standard Base +				TXV + Solenoid			
R-404A	R-448A/R-449A	R-407A/F	R-407C	R-404A	R-448A/R-449A	R-407A/F	R-407C	R-404A	R-448A/R-449A	R-407A/F	R-407C
B0250	B0251	B0252	B0253	B0450	B0453	B0456	B0459	B0451	B0454	B0457	B0460

AIR DEFROST PREFERRED MODELS

Air Defrost Models with 3 Phase AC Totally Enclosed Rail Mount Motors - 575/3/60

Base Model	# of Fans	Fan Size (Inch)	List Price (\$US)			
			B0000	B0250, B0251, B0252, B0253	B0450, B0453, B0456, B0459	B0451, B0454, B0457, B0460
LEH0553ES6ATA	2	24"	21,563	29,451	23,190	24,094
LEH0723ES6ATA	2	24"	24,034	31,922	25,661	26,565
LEH0743ES6ATA	3	24"	29,074	36,962	30,701	31,605
LEH0933ES6ATA	3	24"	31,179	39,067	32,806	33,710
LEH1053ES6ATA	4	24"	34,026	41,914	35,955	37,083
LEH1313ES6ATA	4	24"	37,041	44,929	38,970	40,098
LEH2203ES6ATA	3	30"	63,015	70,903	65,126	66,384
LEH2883ES6ATA	4	30"	79,357	Call	81,468	82,726
LEH2513ES8ATA	3	30"	69,584	77,472	71,695	72,953
LEH3283ES8ATA	4	30"	82,913	Call	85,024	86,282

Air Defrost Models with Variable Speed EC Rail Mount Motors - 208-230/3/60

Base Model	# of Fans	Fan Size (Inch)	List Price (\$US)			
			B0000	B0250, B0251, B0252, B0253	B0450, B0453, B0456, B0459	B0451, B0454, B0457, B0460
LEH0553CS6AVA	2	24"	33,920	41,808	35,547	36,451
LEH0723CS6AVA	2	24"	36,339	44,227	37,966	38,870
LEH0743CS6AVA	3	24"	47,660	55,548	49,287	50,191
LEH0933CS6AVA	3	24"	49,728	57,616	51,355	52,259
LEH1053CS6AVA	4	24"	58,897	66,785	60,826	61,954
LEH1313CS6AVA	4	24"	61,855	69,743	63,784	64,912
LEH1333DS6AVA	3	30"	72,284	80,172	74,213	75,341
LEH1623DS6AVA	3	30"	81,257	89,145	83,186	84,314
LEH1873DS6AVA	3	30"	85,746	93,634	88,127	89,115
LEH2203DS6AVA	3	30"	101,017	108,905	103,128	104,386
LEH2553DS6AVA	4	30"	109,536	117,424	111,647	112,905
LEH2883DS6AVA	4	30"	127,046	Call	129,157	130,415
LEH2513DS8AVA	3	30"	111,782	119,670	113,893	115,151
LEH2953DS8AVA	4	30"	123,451	Call	125,562	126,820
LEH3283DS8AVA	4	30"	132,873	Call	134,984	136,242



PREFERRED OPTION PACKAGES

intelliGen™				Standard Base +				TXV + Solenoid			
R-404A	R-448A/R-449A	R-407A/F	R-407C	TXV				TXV + Solenoid			
B0250	B0251	B0252	B0253	R-404A	R-448A/R-449A	R-407A/F	R-407C	R-404A	R-448A/R-449A	R-407A/F	R-407C
B0250	B0251	B0252	B0253	B0450	B0453	B0456	B0459	B0451	B0454	B0457	B0460

AIR DEFROST PREFERRED MODELS

Air Defrost Models with Variable Speed EC Rail Mount Motors - 460/3/60

Base Model	# of Fans	Fan Size (Inch)	List Price (\$US)			
			B0000	B0250, B0251, B0252, B0253	B0450, B0453, B0456, B0459	B0451, B0454, B0457, B0460
LEH0553DS6AVA	2	24"	33,920	41,808	35,547	36,451
LEH0723DS6AVA	2	24"	36,339	44,227	37,966	38,870
LEH0743DS6AVA	3	24"	47,660	55,548	49,287	50,191
LEH0933DS6AVA	3	24"	49,728	57,616	51,355	52,259
LEH1053DS6AVA	4	24"	58,897	66,785	60,826	61,954
LEH1313DS6AVA	4	24"	61,855	69,743	63,784	64,912
LEH1333DS6AVA	3	30"	72,284	80,172	74,213	75,341
LEH1623DS6AVA	3	30"	81,257	89,145	83,186	84,314
LEH1873DS6AVA	3	30"	85,746	93,634	88,127	89,115
LEH2203DS6AVA	3	30"	101,017	108,905	103,128	104,386
LEH2553DS6AVA	4	30"	109,536	117,424	111,647	112,905
LEH2883DS6AVA	4	30"	127,046	Call	129,157	130,415
LEH2513DS8AVA	3	30"	111,782	119,670	113,893	115,151
LEH2953DS8AVA	4	30"	123,451	Call	125,562	126,820
LEH3283DS8AVA	4	30"	132,873	Call	134,984	136,242



PREFERRED OPTION PACKAGES

Standard Base +											
intelliGen™				TXV				TXV + Solenoid			
R-404A	R-448A/R-449A	R-407A/F	R-407C	R-404A	R-448A/R-449A	R-407A/F	R-407C	R-404A	R-448A/R-449A	R-407A/F	R-407C
B0250	B0251	B0252	B0253	B0450	B0453	B0456	B0459	B0451	B0454	B0457	B0460

ELECTRIC DEFROST PREFERRED MODELS

Electric Defrost Models with 2-Speed EC Motors - 208-230/3/60

Base Model	# of Fans	Fan Size (Inch)	List Price (\$US)			
			B0000	B0250, B0251, B0252, B0253	B0450, B0453, B0456, B0459	B0451, B0454, B0457, B0460
LEH0423CS6EMA	2	24"	29,588	37,476	31,215	32,119
LEH0513CS6EMA	2	24"	33,022	40,910	34,649	35,553
LEH0540CS6EMA	2	24"	32,987	40,875	34,614	35,518
LEH0573CS6EMA	3	24"	35,999	43,887	37,626	38,530
LEH0630CS6EMA	2	24"	37,010	44,898	38,637	39,541
LEH0713CS6EMA	3	24"	41,418	49,306	43,045	43,949
LEH0763CS6EMA	4	24"	49,081	56,969	51,010	52,138
LEH0805CS6EMA	3	24"	41,521	49,409	43,148	44,052
LEH0925CS6EMA	3	24"	49,279	57,167	51,208	52,336
LEH0963CS6EMA	4	24"	52,859	60,747	54,788	55,916
LEH1125CS6EMA	4	24"	58,151	66,039	60,080	61,208
LEH1210CS6EMA	4	24"	66,847	74,735	68,776	69,904
LEH0373CS4EMA	2	24"	27,962	35,850	29,589	30,493
LEH0473CS4EMA	2	24"	32,778	40,666	34,405	35,309
LEH0480CS4EMA	2	24"	30,649	38,537	32,276	33,180
LEH0513CS4EMA	3	24"	35,466	43,354	37,093	37,997
LEH0565CS4EMA	2	24"	36,631	44,519	38,258	39,162
LEH0653CS4EMA	3	24"	38,386	46,274	40,013	40,917
LEH0693CS4EMA	4	24"	41,418	49,306	43,347	44,475
LEH0730CS4EMA	3	24"	40,744	48,632	42,371	43,275
LEH0845CS4EMA	3	24"	45,014	52,902	46,641	47,545
LEH0883CS4EMA	4	24"	52,057	59,945	53,986	55,114
LEH1010CS4EMA	4	24"	49,279	NA	51,208	52,336
LEH1085CS4EMA	4	24"	64,028	71,916	65,957	67,085
LEH1123CS6EMA	3	30"	55,884	63,772	57,813	58,941
LEH1340CS6EMA	3	30"	63,908	71,796	65,955	67,151
LEH1343CS6EMA	3	30"	63,908	71,796	65,837	66,965
LEH1560CS6EMA	3	30"	70,085	77,973	72,466	Call
LEH1563CS6EMA	3	30"	70,085	77,973	72,466	Call
LEH1820CS6EMA	3	30"	90,772	98,660	93,297	94,141
LEH2330CS6EMA	4	30"	110,837	118,725	112,884	114,411
LEH1823CS6EMA	3	30"	90,772	98,660	93,297	94,141
LEH2333CS6EMA	4	30"	110,837	Call	112,766	114,206
LEH0983CS4EMA	3	30"	55,264	63,152	57,193	58,321
LEH1163CS4EMA	3	30"	62,679	70,567	64,608	65,736
LEH1343CS4EMA	3	30"	69,475	77,363	71,856	72,532
LEH1583CS4EMA	3	30"	87,685	95,573	89,614	91,054
LEH2053CS4EMA	4	30"	105,896	113,784	107,825	109,265



PREFERRED OPTION PACKAGES

Standard Base +											
intelliGen™				TXV				TXV + Solenoid			
R-404A	R-448A/R-449A	R-407A/F	R-407C	R-404A	R-448A/R-449A	R-407A/F	R-407C	R-404A	R-448A/R-449A	R-407A/F	R-407C
B0250	B0251	B0252	B0253	B0450	B0453	B0456	B0459	B0451	B0454	B0457	B0460

ELECTRIC DEFROST PREFERRED MODELS

Electric Defrost Models with 2-Speed EC Motors - 460/3/60

Base Model	# of Fans	Fan Size (Inch)	List Price (\$US)			
			B0000	B0250, B0251, B0252, B0253	B0450, B0453, B0456, B0459	B0451, B0454, B0457, B0460
LEH0423DS6EMA	2	24"	29,588	37,476	31,215	32,119
LEH0513DS6EMA	2	24"	33,022	40,910	34,649	35,553
LEH0540DS6EMA	2	24"	34,734	42,622	36,361	37,265
LEH0573DS6EMA	3	24"	35,999	43,887	37,626	38,530
LEH0630DS6EMA	2	24"	38,678	46,566	40,305	41,209
LEH0713DS6EMA	3	24"	41,418	49,306	43,045	43,949
LEH0763DS6EMA	4	24"	49,081	56,969	51,010	52,138
LEH0805DS6EMA	3	24"	44,085	51,973	45,712	46,616
LEH0925DS6EMA	3	24"	50,603	58,491	52,532	53,660
LEH0963DS6EMA	4	24"	52,859	60,747	54,788	55,916
LEH1125DS6EMA	4	24"	61,483	69,371	63,412	64,540
LEH1210DS6EMA	4	24"	66,847	74,735	68,776	69,904
LEH0373DS4EMA	2	24"	27,962	35,850	29,589	30,493
LEH0473DS4EMA	2	24"	32,778	40,666	34,405	35,309
LEH0480DS4EMA	2	24"	32,130	40,018	33,757	34,661
LEH0513DS4EMA	3	24"	35,466	43,354	37,093	37,997
LEH0565DS4EMA	2	24"	39,096	46,984	40,723	41,627
LEH0653DS4EMA	3	24"	38,386	46,274	40,013	40,917
LEH0693DS4EMA	4	24"	41,418	49,306	43,347	44,475
LEH0730DS4EMA	3	24"	44,173	52,061	45,800	46,704
LEH0845DS4EMA	3	24"	48,524	56,412	50,151	51,055
LEH0883DS4EMA	4	24"	52,057	59,945	53,986	55,114
LEH1010DS4EMA	4	24"	51,995	59,883	53,924	55,052
LEH1085DS4EMA	4	24"	68,868	76,756	70,797	71,925
LEH1123DS6EMA	3	30"	56,846	64,734	58,775	59,903
LEH1340DS6EMA	3	30"	65,009	72,897	67,056	68,252
LEH1343DS6EMA	3	30"	65,009	72,897	66,938	68,066
LEH1560DS6EMA	3	30"	71,292	79,180	73,817	Call
LEH1563DS6EMA	3	30"	71,292	79,180	73,673	Call
LEH1820DS6EMA	3	30"	92,335	100,223	94,860	95,704
LEH2330DS6EMA	4	30"	112,747	120,635	114,794	116,321
LEH1823DS6EMA	3	30"	92,335	100,223	94,860	95,704
LEH2333DS6EMA	4	30"	112,747	Call	114,676	116,116
LEH0983DS4EMA	3	30"	56,215	64,103	58,144	59,272
LEH1163DS4EMA	3	30"	63,759	71,647	65,688	66,816
LEH1343DS4EMA	3	30"	70,670	78,558	73,051	73,727
LEH1583DS4EMA	3	30"	89,194	97,082	91,123	92,563
LEH2053DS4EMA	4	30"	107,720	115,608	109,649	111,089



PREFERRED OPTION PACKAGES

intelliGen™				Standard Base +				TXV + Solenoid			
R-404A	R-448A/R-449A	R-407A/F	R-407C	R-404A	R-448A/R-449A	R-407A/F	R-407C	R-404A	R-448A/R-449A	R-407A/F	R-407C
B0250	B0251	B0252	B0253	B0450	B0453	B0456	B0459	B0451	B0454	B0457	B0460

ELECTRIC DEFROST PREFERRED MODELS

Electric Defrost Models with PSC Open Drip Proof Rail Mount Motors - 208-230/3/60

Base Model	# of Fans	Fan Size (Inch)	List Price (\$US)			
			B0000	B0250, B0251, B0252, B0253	B0450, B0453, B0456, B0459	B0451, B0454, B0457, B0460
LEH0423CS6EPA	2	24"	24,648	32,536	26,275	27,179
LEH0513CS6EPA	2	24"	28,114	36,002	29,741	30,645
LEH0573CS6EPA	3	24"	31,119	39,007	32,746	33,650
LEH0713CS6EPA	3	24"	36,593	44,481	38,220	39,124
LEH0763CS6EPA	4	24"	44,329	52,217	46,258	47,386
LEH0963CS6EPA	4	24"	48,144	56,032	50,073	51,201
LEH0373CS4EPA	2	24"	23,006	30,894	24,633	25,537
LEH0473CS4EPA	2	24"	27,868	35,756	29,495	30,399
LEH0513CS4EPA	3	24"	30,583	38,471	32,210	33,114
LEH0653CS4EPA	3	24"	33,531	41,419	35,158	36,062
LEH0693CS4EPA	4	24"	36,593	44,481	38,522	39,650
LEH0883CS4EPA	4	24"	47,332	55,220	49,261	50,389

Electric Defrost Models with PSC Open Drip Proof Rail Mount Motors - 460/3/60

Base Model	# of Fans	Fan Size (Inch)	List Price (\$US)			
			B0000	B0250, B0251, B0252, B0253	B0450, B0453, B0456, B0459	B0451, B0454, B0457, B0460
LEH0423DS6EPA	2	24"	24,648	32,536	26,275	27,179
LEH0513DS6EPA	2	24"	28,114	36,002	29,741	30,645
LEH0573DS6EPA	3	24"	31,119	39,007	32,746	33,650
LEH0713DS6EPA	3	24"	36,593	44,481	38,220	39,124
LEH0763DS6EPA	4	24"	44,329	52,217	46,258	47,386
LEH0963DS6EPA	4	24"	48,144	56,032	50,073	51,201
LEH0373DS4EPA	2	24"	23,006	30,894	24,633	25,537
LEH0473DS4EPA	2	24"	27,868	35,756	29,495	30,399
LEH0513DS4EPA	3	24"	30,583	38,471	32,210	33,114
LEH0653DS4EPA	3	24"	33,531	41,419	35,158	36,062
LEH0693DS4EPA	4	24"	36,593	44,481	38,522	39,650
LEH0883DS4EPA	4	24"	47,332	55,220	49,261	50,389



PREFERRED OPTION PACKAGES

intelliGen™				Standard Base +				TXV + Solenoid			
R-404A	R-448A/R-449A	R-407A/F	R-407C	R-404A	R-448A/R-449A	R-407A/F	R-407C	R-404A	R-448A/R-449A	R-407A/F	R-407C
B0250	B0251	B0252	B0253	B0450	B0453	B0456	B0459	B0451	B0454	B0457	B0460

ELECTRIC DEFROST PREFERRED MODELS

Electric Defrost Models with 3 Phase AC Totally Enclosed Rail Mount Motors - 208-230/3/60

Base Model	# of Fans	Fan Size (Inch)	List Price (\$US)			
			B0000	B0250, B0251, B0252, B0253	B0450, B0453, B0456, B0459	B0451, B0454, B0457, B0460
LEH0423CS6ETA	2	24"	24,998	32,886	26,625	27,529
LEH0513CS6ETA	2	24"	28,487	36,375	30,114	31,018
LEH0573CS6ETA	3	24"	31,683	39,571	33,310	34,214
LEH0713CS6ETA	3	24"	37,051	44,939	38,678	39,582
LEH0763CS6ETA	4	24"	45,078	52,966	47,007	48,135
LEH0963CS6ETA	4	24"	48,849	56,737	50,778	51,906
LEH0373CS4ETA	2	24"	23,379	31,267	25,006	25,910
LEH0473CS4ETA	2	24"	28,218	36,106	29,845	30,749
LEH0513CS4ETA	3	24"	31,144	39,032	32,771	33,675
LEH0653CS4ETA	3	24"	34,099	41,987	35,726	36,630
LEH0693CS4ETA	4	24"	37,299	45,187	39,228	40,356
LEH0883CS4ETA	4	24"	48,039	55,927	49,968	51,096
LEH1123CS6ETA	3	30"	49,960	57,848	51,889	53,017
LEH1343CS6ETA	3	30"	56,939	64,827	58,868	59,996
LEH1563CS6ETA	3	30"	62,312	70,200	64,693	Call
LEH1823CS6ETA	3	30"	80,305	88,193	82,830	83,674
LEH2333CS6ETA	4	30"	98,208	Call	100,137	101,577
LEH0983CS4ETA	3	30"	49,419	57,307	51,348	52,476
LEH1163CS4ETA	3	30"	55,870	63,758	57,799	58,927
LEH1343CS4ETA	3	30"	61,780	69,668	64,161	64,837
LEH1583CS4ETA	3	30"	77,619	85,507	79,548	80,988
LEH2053CS4ETA	4	30"	93,911	101,799	95,840	97,280



PREFERRED OPTION PACKAGES

intelliGen™				Standard Base +				TXV + Solenoid			
R-404A	R-448A/R-449A	R-407A/F	R-407C	R-404A	R-448A/R-449A	R-407A/F	R-407C	R-404A	R-448A/R-449A	R-407A/F	R-407C
B0250	B0251	B0252	B0253	B0450	B0453	B0456	B0459	B0451	B0454	B0457	B0460

ELECTRIC DEFROST PREFERRED MODELS

Electric Defrost Models with 3 Phase AC Totally Enclosed Rail Mount Motors - 380-400/3/50

Base Model	# of Fans	Fan Size (Inch)	List Price (\$US)			
			B0000	B0250, B0251, B0252, B0253	B0450, B0453, B0456, B0459	B0451, B0454, B0457, B0460
LEH0423XS6ETA	2	24"	24,998	32,886	26,625	27,529
LEH0513XS6ETA	2	24"	28,487	36,375	30,114	31,018
LEH0573XS6ETA	3	24"	31,683	39,571	33,310	34,214
LEH0713XS6ETA	3	24"	37,051	44,939	38,678	39,582
LEH0763XS6ETA	4	24"	45,078	52,966	47,007	48,135
LEH0963XS6ETA	4	24"	48,849	56,737	50,778	51,906
LEH0373XS4ETA	2	24"	23,379	31,267	25,006	25,910
LEH0473XS4ETA	2	24"	28,218	36,106	29,845	30,749
LEH0513XS4ETA	3	24"	31,144	39,032	32,771	33,675
LEH0653XS4ETA	3	24"	34,099	41,987	35,726	36,630
LEH0693XS4ETA	4	24"	37,299	45,187	39,228	40,356
LEH0883XS4ETA	4	24"	48,039	55,927	49,968	51,096
LEH1123XS6ETA	3	30"	49,960	57,848	51,889	53,017
LEH1343XS6ETA	3	30"	56,939	64,827	58,868	59,996
LEH1563XS6ETA	3	30"	62,312	70,200	64,693	Call
LEH1823XS6ETA	3	30"	80,305	88,193	82,830	83,674
LEH2333XS6ETA	4	30"	98,208	Call	100,137	101,577
LEH0983XS4ETA	3	30"	49,419	57,307	51,348	52,476
LEH1163XS4ETA	3	30"	55,870	63,758	57,799	58,927
LEH1343XS4ETA	3	30"	61,780	69,668	64,161	64,837
LEH1583XS4ETA	3	30"	77,619	85,507	79,548	80,988
LEH2053XS4ETA	4	30"	93,911	101,799	95,840	97,280



PREFERRED OPTION PACKAGES

intelliGen™				Standard Base +				TXV + Solenoid			
R-404A	R-448A/R-449A	R-407A/F	R-407C	R-404A	R-448A/R-449A	R-407A/F	R-407C	R-404A	R-448A/R-449A	R-407A/F	R-407C
B0250	B0251	B0252	B0253	B0450	B0453	B0456	B0459	B0451	B0454	B0457	B0460

ELECTRIC DEFROST PREFERRED MODELS

Electric Defrost Models with 3 Phase AC Totally Enclosed Rail Mount Motors - 460/3/60

Base Model	# of Fans	Fan Size (Inch)	List Price (\$US)			
			B0000	B0250, B0251, B0252, B0253	B0450, B0453, B0456, B0459	B0451, B0454, B0457, B0460
LEH0423DS6ETA	2	24"	24,998	32,886	26,625	27,529
LEH0513DS6ETA	2	24"	28,487	36,375	30,114	31,018
LEH0573DS6ETA	3	24"	31,683	39,571	33,310	34,214
LEH0713DS6ETA	3	24"	37,051	44,939	38,678	39,582
LEH0763DS6ETA	4	24"	45,078	52,966	47,007	48,135
LEH0963DS6ETA	4	24"	48,849	56,737	50,778	51,906
LEH0373DS4ETA	2	24"	23,379	31,267	25,006	25,910
LEH0473DS4ETA	2	24"	28,218	36,106	29,845	30,749
LEH0513DS4ETA	3	24"	31,144	39,032	32,771	33,675
LEH0653DS4ETA	3	24"	34,099	41,987	35,726	36,630
LEH0693DS4ETA	4	24"	37,299	45,187	39,228	40,356
LEH0883DS4ETA	4	24"	48,039	55,927	49,968	51,096
LEH1123DS6ETA	3	30"	49,960	57,848	51,889	53,017
LEH1343DS6ETA	3	30"	56,939	64,827	58,868	59,996
LEH1563DS6ETA	3	30"	62,312	70,200	64,693	Call
LEH1823DS6ETA	3	30"	80,305	88,193	82,830	83,674
LEH2333DS6ETA	4	30"	98,208	Call	100,137	101,577
LEH0983DS4ETA	3	30"	49,419	57,307	51,348	52,476
LEH1163DS4ETA	3	30"	55,870	63,758	57,799	58,927
LEH1343DS4ETA	3	30"	61,780	69,668	64,161	64,837
LEH1583DS4ETA	3	30"	77,619	85,507	79,548	80,988
LEH2053DS4ETA	4	30"	93,911	101,799	95,840	97,280



PREFERRED OPTION PACKAGES

intelliGen™				Standard Base +				TXV + Solenoid			
R-404A	R-448A/R-449A	R-407A/F	R-407C	TXV				TXV + Solenoid			
B0250	B0251	B0252	B0253	R-404A	R-448A/R-449A	R-407A/F	R-407C	R-404A	R-448A/R-449A	R-407A/F	R-407C
B0250	B0251	B0252	B0253	B0450	B0453	B0456	B0459	B0451	B0454	B0457	B0460

ELECTRIC DEFROST PREFERRED MODELS

Electric Defrost Models with 3 Phase AC Totally Enclosed Rail Mount Motors - 575/3/60

Base Model	# of Fans	Fan Size (Inch)	List Price (\$US)			
			B0000	B0250, B0251, B0252, B0253	B0450, B0453, B0456, B0459	B0451, B0454, B0457, B0460
LEH0423ES6ETA	2	24"	25,124	33,012	26,751	27,655
LEH0513ES6ETA	2	24"	28,663	36,551	30,290	31,194
LEH0573ES6ETA	3	24"	31,728	39,616	33,355	34,259
LEH0713ES6ETA	3	24"	37,311	45,199	38,938	39,842
LEH0763ES6ETA	4	24"	45,204	53,092	47,133	48,261
LEH0963ES6ETA	4	24"	49,090	56,978	51,019	52,147
LEH0373ES4ETA	2	24"	23,457	31,345	25,084	25,988
LEH0473ES4ETA	2	24"	28,412	36,300	30,039	30,943
LEH0513ES4ETA	3	24"	31,179	39,067	32,806	33,710
LEH0653ES4ETA	3	24"	34,191	42,079	35,818	36,722
LEH0693ES4ETA	4	24"	37,311	45,199	39,240	40,368
LEH0883ES4ETA	4	24"	48,270	56,158	50,199	51,327
LEH1823ES6ETA	3	30"	81,911	89,799	84,436	85,280
LEH2333ES6ETA	4	30"	100,174	Call	102,103	103,543
LEH1583ES4ETA	3	30"	79,171	87,059	81,100	82,540
LEH2053ES4ETA	4	30"	95,789	103,677	97,718	99,158



PREFERRED OPTION PACKAGES

intelliGen™				Standard Base +				TXV + Solenoid			
R-404A	R-448A/R-449A	R-407A/F	R-407C	R-404A	R-448A/R-449A	R-407A/F	R-407C	R-404A	R-448A/R-449A	R-407A/F	R-407C
B0250	B0251	B0252	B0253	B0450	B0453	B0456	B0459	B0451	B0454	B0457	B0460

ELECTRIC DEFROST PREFERRED MODELS

Electric Defrost Models with 3 Phase AC Open Drip Proof Rail Mount Motors - 208-230/3/60

Base Model	# of Fans	Fan Size (Inch)	List Price (\$US)			
			B0000	B0250, B0251, B0252, B0253	B0450, B0453, B0456, B0459	B0451, B0454, B0457, B0460
LEH0423CS6EYA	2	24"	24,648	32,536	26,275	27,179
LEH0513CS6EYA	2	24"	28,114	36,002	29,741	30,645
LEH0573CS6EYA	3	24"	31,119	39,007	32,746	33,650
LEH0713CS6EYA	3	24"	36,593	44,481	38,220	39,124
LEH0763CS6EYA	4	24"	44,329	52,217	46,258	47,386
LEH0963CS6EYA	4	24"	48,144	56,032	50,073	51,201
LEH0373CS4EYA	2	24"	23,006	30,894	24,633	25,537
LEH0473CS4EYA	2	24"	27,868	35,756	29,495	30,399
LEH0513CS4EYA	3	24"	30,583	38,471	32,210	33,114
LEH0653CS4EYA	3	24"	33,531	41,419	35,158	36,062
LEH0693CS4EYA	4	24"	36,593	44,481	38,522	39,650
LEH0883CS4EYA	4	24"	47,332	55,220	49,261	50,389
LEH1123CS6EYA	3	30"	48,607	56,495	50,536	51,664
LEH1343CS6EYA	3	30"	55,587	63,475	57,516	58,644
LEH1563CS6EYA	3	30"	60,958	68,846	63,339	Call
LEH1823CS6EYA	3	30"	78,952	86,840	81,477	82,321
LEH2333CS6EYA	4	30"	96,405	Call	98,334	99,774
LEH0983CS4EYA	3	30"	48,067	55,955	49,996	51,124
LEH1163CS4EYA	3	30"	54,518	62,406	56,447	57,575
LEH1343CS4EYA	3	30"	60,427	68,315	62,808	63,484
LEH1583CS4EYA	3	30"	76,266	84,154	78,195	79,635
LEH2053CS4EYA	4	30"	92,107	99,995	94,036	95,476



PREFERRED OPTION PACKAGES

intelliGen™				Standard Base +				TXV + Solenoid			
R-404A	R-448A/R-449A	R-407A/F	R-407C	R-404A	R-448A/R-449A	R-407A/F	R-407C	R-404A	R-448A/R-449A	R-407A/F	R-407C
B0250	B0251	B0252	B0253	B0450	B0453	B0456	B0459	B0451	B0454	B0457	B0460

ELECTRIC DEFROST PREFERRED MODELS

Electric Defrost Models with 3 Phase AC Open Drip Proof Rail Mount Motors - 380-400/3/50

Base Model	# of Fans	Fan Size (Inch)	List Price (\$US)			
			B0000	B0250, B0251, B0252, B0253	B0450, B0453, B0456, B0459	B0451, B0454, B0457, B0460
LEH0423XS6EYA	2	24"	24,648	32,536	26,275	27,179
LEH0513XS6EYA	2	24"	28,114	36,002	29,741	30,645
LEH0573XS6EYA	3	24"	31,119	39,007	32,746	33,650
LEH0713XS6EYA	3	24"	36,593	44,481	38,220	39,124
LEH0763XS6EYA	4	24"	44,329	52,217	46,258	47,386
LEH0963XS6EYA	4	24"	48,144	56,032	50,073	51,201
LEH0373XS4EYA	2	24"	23,006	30,894	24,633	25,537
LEH0473XS4EYA	2	24"	27,868	35,756	29,495	30,399
LEH0513XS4EYA	3	24"	30,583	38,471	32,210	33,114
LEH0653XS4EYA	3	24"	33,531	41,419	35,158	36,062
LEH0693XS4EYA	4	24"	36,593	44,481	38,522	39,650
LEH0883XS4EYA	4	24"	47,332	55,220	49,261	50,389
LEH1563XS6EYA	3	30"	60,958	68,846	63,339	Call
LEH1823XS6EYA	3	30"	78,952	86,840	81,477	82,321
LEH2333XS6EYA	4	30"	96,405	Call	98,334	99,774
LEH1343XS4EYA	3	30"	60,427	68,315	62,808	63,484
LEH1583XS4EYA	3	30"	76,266	84,154	78,195	79,635
LEH2053XS4EYA	4	30"	92,107	99,995	94,036	95,476



PREFERRED OPTION PACKAGES

intelliGen™				Standard Base +				TXV + Solenoid			
R-404A	R-448A/R-449A	R-407A/F	R-407C	R-404A	R-448A/R-449A	R-407A/F	R-407C	R-404A	R-448A/R-449A	R-407A/F	R-407C
B0250	B0251	B0252	B0253	B0450	B0453	B0456	B0459	B0451	B0454	B0457	B0460

ELECTRIC DEFROST PREFERRED MODELS

Electric Defrost Models with 3 Phase AC Open Drip Proof Rail Mount Motors - 460/3/60

Base Model	# of Fans	Fan Size (Inch)	List Price (\$US)			
			B0000	B0250, B0251, B0252, B0253	B0450, B0453, B0456, B0459	B0451, B0454, B0457, B0460
LEH0423DS6EYA	2	24"	24,648	32,536	26,275	27,179
LEH0513DS6EYA	2	24"	28,114	36,002	29,741	30,645
LEH0573DS6EYA	3	24"	31,119	39,007	32,746	33,650
LEH0713DS6EYA	3	24"	36,593	44,481	38,220	39,124
LEH0763DS6EYA	4	24"	44,329	52,217	46,258	47,386
LEH0963DS6EYA	4	24"	48,144	56,032	50,073	51,201
LEH0373DS4EYA	2	24"	23,006	30,894	24,633	25,537
LEH0473DS4EYA	2	24"	27,868	35,756	29,495	30,399
LEH0513DS4EYA	3	24"	30,583	38,471	32,210	33,114
LEH0653DS4EYA	3	24"	33,531	41,419	35,158	36,062
LEH0693DS4EYA	4	24"	36,593	44,481	38,522	39,650
LEH0883DS4EYA	4	24"	47,332	55,220	49,261	50,389
LEH1123DS6EYA	3	30"	48,607	56,495	50,536	51,664
LEH1343DS6EYA	3	30"	55,587	63,475	57,516	58,644
LEH1563DS6EYA	3	30"	60,958	68,846	63,483	Call
LEH1823DS6EYA	3	30"	78,952	86,840	81,477	82,321
LEH2333DS6EYA	4	30"	96,405	Call	98,334	99,774
LEH0983DS4EYA	3	30"	48,067	55,955	49,996	51,124
LEH1163DS4EYA	3	30"	54,518	62,406	56,447	57,575
LEH1343DS4EYA	3	30"	60,427	68,315	62,808	63,484
LEH1583DS4EYA	3	30"	76,266	84,154	78,195	79,635
LEH2053DS4EYA	4	30"	92,107	99,995	94,036	95,476



PREFERRED OPTION PACKAGES

Standard Base +											
intelliGen™				TXV				TXV + Solenoid			
R-404A	R-448A/R-449A	R-407A/F	R-407C	R-404A	R-448A/R-449A	R-407A/F	R-407C	R-404A	R-448A/R-449A	R-407A/F	R-407C
B0250	B0251	B0252	B0253	B0450	B0453	B0456	B0459	B0451	B0454	B0457	B0460

ELECTRIC DEFROST PREFERRED MODELS

Electric Defrost Models with 3 Phase AC Open Drip Proof Rail Mount Motors - 575/3/60

Base Model	# of Fans	Fan Size (Inch)	List Price (\$US)			
			B0000	B0250, B0251, B0252, B0253	B0450, B0453, B0456, B0459	B0451, B0454, B0457, B0460
LEH1123ES6EYA	3	30"	49,577	57,465	51,506	52,634
LEH1343ES6EYA	3	30"	56,696	64,584	58,625	59,753
LEH1563ES6EYA	3	30"	62,182	70,070	64,563	Call
LEH0983ES4EYA	3	30"	49,027	56,915	50,956	52,084
LEH1163ES4EYA	3	30"	55,607	63,495	57,536	58,664
LEH1343ES4EYA	3	30"	61,629	69,517	64,010	64,686

Electric Defrost Models with Variable Speed EC Rail Mount Motors - 208-230/3/60

Base Model	# of Fans	Fan Size (Inch)	List Price (\$US)			
			B0000	B0250, B0251, B0252, B0253	B0450, B0453, B0456, B0459	B0451, B0454, B0457, B0460
LEH0423CS6EVA	2	24"	37,411	45,299	39,038	39,942
LEH0513CS6EVA	2	24"	40,876	48,764	42,503	43,407
LEH0573CS6EVA	3	24"	50,266	58,154	51,893	52,797
LEH0713CS6EVA	3	24"	55,738	63,626	57,365	58,269
LEH0763CS6EVA	4	24"	69,858	77,746	71,787	72,915
LEH0963CS6EVA	4	24"	73,672	81,560	75,601	76,729
LEH0373CS4EVA	2	24"	35,769	43,657	37,396	38,300
LEH0473CS4EVA	2	24"	40,631	48,519	42,258	43,162
LEH0513CS4EVA	3	24"	49,728	57,616	51,355	52,259
LEH0653CS4EVA	3	24"	52,676	60,564	54,303	55,207
LEH0693CS4EVA	4	24"	62,119	70,007	64,048	65,176
LEH0883CS4EVA	4	24"	72,860	80,748	74,789	75,917
LEH1123CS6EVA	3	30"	75,596	83,484	77,525	78,653
LEH1343CS6EVA	3	30"	86,451	94,339	88,380	89,508
LEH1563CS6EVA	3	30"	94,805	102,693	97,186	Call
LEH1823CS6EVA	3	30"	122,789	130,677	125,314	126,158
LEH2333CS6EVA	4	30"	149,934	Call	151,863	153,303
LEH0983CS4EVA	3	30"	74,755	82,643	76,684	77,812
LEH1163CS4EVA	3	30"	84,789	92,677	86,718	87,846
LEH1343CS4EVA	3	30"	93,979	101,867	96,360	97,036
LEH1583CS4EVA	3	30"	118,613	126,501	120,542	121,982
LEH2053CS4EVA	4	30"	143,249	151,137	145,178	146,618



PREFERRED OPTION PACKAGES

intelliGen™				Standard Base +				TXV + Solenoid			
R-404A	R-448A/R-449A	R-407A/F	R-407C	R-404A	R-448A/R-449A	R-407A/F	R-407C	R-404A	R-448A/R-449A	R-407A/F	R-407C
B0250	B0251	B0252	B0253	B0450	B0453	B0456	B0459	B0451	B0454	B0457	B0460

ELECTRIC DEFROST PREFERRED MODELS

Electric Defrost Models with Variable Speed EC Rail Mount Motors - 460/3/60

Base Model	# of Fans	Fan Size (Inch)	List Price (\$US)			
			B0000	B0250, B0251, B0252, B0253	B0450, B0453, B0456, B0459	B0451, B0454, B0457, B0460
LEH0423DS6EVA	2	24"	37,411	45,299	39,038	39,942
LEH0513DS6EVA	2	24"	40,876	48,764	42,503	43,407
LEH0573DS6EVA	3	24"	50,266	58,154	51,893	52,797
LEH0713DS6EVA	3	24"	55,738	63,626	57,365	58,269
LEH0763DS6EVA	4	24"	69,858	77,746	71,787	72,915
LEH0963DS6EVA	4	24"	73,672	81,560	75,601	76,729
LEH0373DS4EVA	2	24"	35,769	43,657	37,396	38,300
LEH0473DS4EVA	2	24"	40,631	48,519	42,258	43,162
LEH0513DS4EVA	3	24"	49,728	57,616	51,355	52,259
LEH0653DS4EVA	3	24"	52,676	60,564	54,303	55,207
LEH0693DS4EVA	4	24"	62,119	70,007	64,048	65,176
LEH0883DS4EVA	4	24"	72,860	80,748	74,789	75,917
LEH1123DS6EVA	3	30"	76,567	84,455	78,496	79,624
LEH1343DS6EVA	3	30"	87,563	95,451	89,492	90,620
LEH1563DS6EVA	3	30"	96,026	103,914	98,407	Call
LEH1823DS6EVA	3	30"	124,368	132,256	126,893	127,737
LEH2333DS6EVA	4	30"	151,861	Call	153,790	155,230
LEH0983DS4EVA	3	30"	75,716	83,604	77,645	78,773
LEH1163DS4EVA	3	30"	85,879	93,767	87,808	88,936
LEH1343DS4EVA	3	30"	95,187	103,075	97,568	98,244
LEH1583DS4EVA	3	30"	120,138	128,026	122,067	123,507
LEH2053DS4EVA	4	30"	145,092	152,980	147,021	148,461



PREFERRED OPTION PACKAGES

intelliGen™				Standard Base +				TXV + Solenoid			
R-404A	R-448A/R-449A	R-407A/F	R-407C	TXV				TXV + Solenoid			
B0250	B0251	B0252	B0253	R-404A	R-448A/R-449A	R-407A/F	R-407C	R-404A	R-448A/R-449A	R-407A/F	R-407C
B0250	B0251	B0252	B0253	B0450	B0453	B0456	B0459	B0451	B0454	B0457	B0460

ELECTRIC DEFROST PREFERRED MODELS

Electric Defrost Models with High CFM Rail Mount Motors - 208-230/3/60

Base Model	# of Fans	Fan Size (Inch)	List Price (\$US)			
			B0000	B0250, B0251, B0252, B0253	B0450, B0453, B0456, B0459	B0451, B0454, B0457, B0460
LEH0423CS6EHA	2	24"	28,137	36,025	29,764	30,668
LEH0513CS6EHA	2	24"	31,626	39,514	33,253	34,157
LEH0573CS6EHA	3	24"	36,392	44,280	38,019	38,923
LEH0713CS6EHA	3	24"	41,759	49,647	43,386	44,290
LEH0763CS6EHA	4	24"	51,357	59,245	53,286	54,414
LEH0963CS6EHA	4	24"	55,128	63,016	57,057	58,185
LEH0373CS4EHA	2	24"	26,519	34,407	28,146	29,050
LEH0473CS4EHA	2	24"	31,356	39,244	32,983	33,887
LEH0513CS4EHA	3	24"	35,854	43,742	37,481	38,385
LEH0653CS4EHA	3	24"	38,808	46,696	40,435	41,339
LEH0693CS4EHA	4	24"	43,577	51,465	45,506	46,634
LEH0883CS4EHA	4	24"	54,315	62,203	56,244	57,372
LEH1123CS6EHA	3	30"	55,201	63,089	57,130	58,258
LEH1343CS6EHA	3	30"	62,181	70,069	64,110	65,238
LEH1563CS6EHA	3	30"	67,554	75,442	69,935	Call
LEH1823CS6EHA	3	30"	85,546	93,434	88,071	88,915
LEH2333CS6EHA	4	30"	105,197	Call	107,126	108,566
LEH0983CS4EHA	3	30"	54,661	62,549	56,590	57,718
LEH1163CS4EHA	3	30"	61,112	69,000	63,041	64,169
LEH1343CS4EHA	3	30"	67,022	74,910	69,403	70,079
LEH1583CS4EHA	3	30"	82,860	90,748	84,789	86,229
LEH2053CS4EHA	4	30"	100,900	108,788	102,829	104,269



PREFERRED OPTION PACKAGES

intelliGen™				Standard Base +				TXV + Solenoid			
R-404A	R-448A/R-449A	R-407A/F	R-407C	R-404A	R-448A/R-449A	R-407A/F	R-407C	R-404A	R-448A/R-449A	R-407A/F	R-407C
B0250	B0251	B0252	B0253	B0450	B0453	B0456	B0459	B0451	B0454	B0457	B0460

ELECTRIC DEFROST PREFERRED MODELS

Electric Defrost Models with High CFM Rail Mount Motors - 460/3/60

Base Model	# of Fans	Fan Size (Inch)	List Price (\$US)			
			B0000	B0250, B0251, B0252, B0253	B0450, B0453, B0456, B0459	B0451, B0454, B0457, B0460
LEH0423DS6EHA	2	24"	28,137	36,025	29,764	30,668
LEH0513DS6EHA	2	24"	31,626	39,514	33,253	34,157
LEH0573DS6EHA	3	24"	36,392	44,280	38,019	38,923
LEH0713DS6EHA	3	24"	41,759	49,647	43,386	44,290
LEH0763DS6EHA	4	24"	51,357	59,245	53,286	54,414
LEH0963DS6EHA	4	24"	55,128	63,016	57,057	58,185
LEH0373DS4EHA	2	24"	26,519	34,407	28,146	29,050
LEH0473DS4EHA	2	24"	31,356	39,244	32,983	33,887
LEH0513DS4EHA	3	24"	35,854	43,742	37,481	38,385
LEH0653DS4EHA	3	24"	38,808	46,696	40,435	41,339
LEH0693DS4EHA	4	24"	43,577	51,465	45,506	46,634
LEH0883DS4EHA	4	24"	54,315	62,203	56,244	57,372
LEH1123DS6EHA	3	30"	55,201	63,089	57,130	58,258
LEH1343DS6EHA	3	30"	62,181	70,069	64,110	65,238
LEH1563DS6EHA	3	30"	67,554	75,442	69,935	Call
LEH1823DS6EHA	3	30"	85,546	93,434	88,071	88,915
LEH2333DS6EHA	4	30"	105,197	Call	107,126	108,566
LEH0983DS4EHA	3	30"	54,661	62,549	56,590	57,718
LEH1163DS4EHA	3	30"	61,112	69,000	63,041	64,169
LEH1343DS4EHA	3	30"	67,022	74,910	69,403	70,079
LEH1583DS4EHA	3	30"	82,860	90,748	84,789	86,229
LEH2053DS4EHA	4	30"	100,900	108,788	102,829	104,269



PREFERRED OPTION PACKAGES

Standard Base +											
intelliGen™				TXV				TXV + Solenoid			
R-404A	R-448A/R-449A	R-407A/F	R-407C	R-404A	R-448A/R-449A	R-407A/F	R-407C	R-404A	R-448A/R-449A	R-407A/F	R-407C
B0250	B0251	B0252	B0253	B0450	B0453	B0456	B0459	B0451	B0454	B0457	B0460

HOT GAS DEFROST PREFERRED MODELS

Hot Gas Defrost Models with 2-Speed EC Motors - 208-230/3/60

Base Model	# of Fans	Fan Size (Inch)	List Price (\$US)			
			B0000	B0250, B0251, B0252, B0253	B0450, B0453, B0456, B0459	B0451, B0454, B0457, B0460
LEH0423CS6HMA	2	24"	28,790	NA	30,417	NA
LEH0513CS6HMA	2	24"	32,509	NA	34,136	NA
LEH0540CS6HMA	2	24"	31,817	NA	33,444	NA
LEH0573CS6HMA	3	24"	35,305	NA	36,932	NA
LEH0630CS6HMA	2	24"	36,255	NA	37,882	NA
LEH0713CS6HMA	3	24"	40,622	NA	42,249	NA
LEH0763CS6HMA	4	24"	47,539	NA	49,468	NA
LEH0805CS6HMA	3	24"	40,353	NA	41,980	NA
LEH0925CS6HMA	3	24"	48,116	NA	50,045	NA
LEH0963CS6HMA	4	24"	52,057	NA	53,986	NA
LEH1125CS6HMA	4	24"	57,437	NA	59,366	NA
LEH1210CS6HMA	4	24"	62,313	NA	64,242	NA
LEH0373CS4HMA	2	24"	27,456	NA	29,083	NA
LEH0473CS4HMA	2	24"	31,985	NA	33,612	NA
LEH0480CS4HMA	2	24"	29,881	NA	31,508	NA
LEH0513CS4HMA	3	24"	35,040	NA	36,667	NA
LEH0565CS4HMA	2	24"	36,480	NA	38,107	NA
LEH0653CS4HMA	3	24"	38,227	NA	39,854	NA
LEH0693CS4HMA	4	24"	41,156	NA	43,085	NA
LEH0730CS4HMA	3	24"	39,970	NA	41,597	NA
LEH0845CS4HMA	3	24"	44,619	NA	46,246	NA
LEH0883CS4HMA	4	24"	51,521	NA	53,450	NA
LEH1010CS4HMA	4	24"	48,116	NA	50,045	NA
LEH1085CS4HMA	4	24"	63,252	NA	65,181	NA
LEH1123CS6HMA	3	30"	54,806	NA	56,735	NA
LEH1340CS6HMA	3	30"	63,161	NA	65,090	NA
LEH1343CS6HMA	3	30"	63,161	NA	65,090	NA
LEH1560CS6HMA	3	30"	69,354	NA	71,879	NA
LEH1563CS6HMA	3	30"	69,354	NA	71,735	NA
LEH1820CS6HMA	3	30"	85,148	NA	87,673	NA
LEH1823CS6HMA	3	30"	85,148	NA	87,529	NA
LEH2330CS6HMA	4	30"	107,125	NA	109,650	NA
LEH2333CS6HMA	4	30"	107,125	NA	109,506	NA
LEH0983CS4HMA	3	30"	54,806	NA	56,735	NA
LEH1163CS4HMA	3	30"	61,926	NA	63,855	NA
LEH1343CS4HMA	3	30"	69,354	NA	71,735	NA
LEH1583CS4HMA	3	30"	87,005	NA	89,386	NA
LEH2053CS4HMA	4	30"	105,274	NA	107,655	NA



PREFERRED OPTION PACKAGES

Standard Base +											
intelliGen™				TXV				TXV + Solenoid			
R-404A	R-448A/R-449A	R-407A/F	R-407C	R-404A	R-448A/R-449A	R-407A/F	R-407C	R-404A	R-448A/R-449A	R-407A/F	R-407C
B0250	B0251	B0252	B0253	B0450	B0453	B0456	B0459	B0451	B0454	B0457	B0460

HOT GAS DEFROST PREFERRED MODELS

Hot Gas Defrost Models with 2-Speed EC Motors - 460/3/60

Base Model	# of Fans	Fan Size (Inch)	List Price (\$US)			
			B0000	B0250, B0251, B0252, B0253	B0450, B0453, B0456, B0459	B0451, B0454, B0457, B0460
LEH0423DS6HMA	2	24"	28,790	NA	30,417	NA
LEH0513DS6HMA	2	24"	32,509	NA	34,136	NA
LEH0540DS6HMA	2	24"	34,239	NA	35,866	NA
LEH0573DS6HMA	3	24"	35,305	NA	36,932	NA
LEH0630DS6HMA	2	24"	38,716	NA	40,343	NA
LEH0713DS6HMA	3	24"	40,622	NA	42,249	NA
LEH0763DS6HMA	4	24"	47,539	NA	49,468	NA
LEH0805DS6HMA	3	24"	43,938	NA	45,565	NA
LEH0925DS6HMA	3	24"	50,466	NA	52,395	NA
LEH0963DS6HMA	4	24"	52,057	NA	53,986	NA
LEH1125DS6HMA	4	24"	60,481	NA	62,410	NA
LEH1210DS6HMA	4	24"	67,047	NA	68,976	NA
LEH0373DS4HMA	2	24"	27,456	NA	29,083	NA
LEH0473DS4HMA	2	24"	31,985	NA	33,612	NA
LEH0480DS4HMA	2	24"	32,258	NA	33,885	NA
LEH0513DS4HMA	3	24"	35,040	NA	36,667	NA
LEH0565DS4HMA	2	24"	37,949	NA	39,576	NA
LEH0653DS4HMA	3	24"	38,227	NA	39,854	NA
LEH0693DS4HMA	4	24"	41,156	NA	43,085	NA
LEH0730DS4HMA	3	24"	42,684	NA	44,311	NA
LEH0845DS4HMA	3	24"	47,339	NA	48,966	NA
LEH0883DS4HMA	4	24"	51,521	NA	53,450	NA
LEH1010DS4HMA	4	24"	52,645	NA	54,574	NA
LEH1085DS4HMA	4	24"	68,075	NA	70,004	NA
LEH1123DS6HMA	3	30"	55,748	NA	57,677	NA
LEH1340DS6HMA	3	30"	64,246	NA	66,175	NA
LEH1343DS6HMA	3	30"	64,246	NA	66,175	NA
LEH1560DS6HMA	3	30"	70,546	NA	73,071	NA
LEH1563DS6HMA	3	30"	70,546	NA	72,927	NA
LEH1820DS6HMA	3	30"	86,610	NA	89,135	NA
LEH1823DS6HMA	3	30"	86,610	NA	88,991	NA
LEH2330DS6HMA	4	30"	108,965	NA	111,346	NA
LEH2333DS6HMA	4	30"	108,965	NA	111,346	NA
LEH0983DS4HMA	3	30"	55,748	NA	57,677	NA
LEH1163DS4HMA	3	30"	62,990	NA	64,919	NA
LEH1343DS4HMA	3	30"	70,546	NA	72,927	NA
LEH1583DS4HMA	3	30"	88,500	NA	90,881	NA
LEH2053DS4HMA	4	30"	107,082	NA	109,463	NA



PREFERRED OPTION PACKAGES

Standard Base +											
intelliGen™				TXV				TXV + Solenoid			
R-404A	R-448A/R-449A	R-407A/F	R-407C	R-404A	R-448A/R-449A	R-407A/F	R-407C	R-404A	R-448A/R-449A	R-407A/F	R-407C
B0250	B0251	B0252	B0253	B0450	B0453	B0456	B0459	B0451	B0454	B0457	B0460

HOT GAS DEFROST PREFERRED MODELS

Hot Gas Defrost Models with PSC Open Drip Proof Rail Mount Motors - 208-230/1/60

Base Model	# of Fans	Fan Size (Inch)	List Price (\$US)			
			B0000	B0250, B0251, B0252, B0253	B0450, B0453, B0456, B0459	B0451, B0454, B0457, B0460
LEH0423BS6HPA	2	24"	22,627	NA	24,254	NA
LEH0513BS6HPA	2	24"	26,390	NA	28,017	NA
LEH0573BS6HPA	3	24"	28,537	NA	30,164	NA
LEH0713BS6HPA	3	24"	33,910	NA	35,537	NA
LEH0763BS6HPA	4	24"	40,358	NA	42,287	NA
LEH0963BS6HPA	4	24"	44,921	NA	46,850	NA
LEH0373BS4HPA	2	24"	21,291	NA	22,918	NA
LEH0473BS4HPA	2	24"	25,857	NA	27,484	NA
LEH0513BS4HPA	3	24"	28,270	NA	29,897	NA
LEH0653BS4HPA	3	24"	31,487	NA	33,114	NA
LEH0693BS4HPA	4	24"	33,910	NA	35,839	NA
LEH0883BS4HPA	4	24"	44,383	NA	46,312	NA
LEH0373BS4HPA	2	24"	21,291	NA	22,918	NA
LEH0473BS4HPA	2	24"	25,857	NA	27,484	NA
LEH0513BS4HPA	3	24"	28,270	NA	29,897	NA
LEH0653BS4HPA	3	24"	31,487	NA	33,114	NA
LEH0693BS4HPA	4	24"	33,910	NA	35,839	NA
LEH0883BS4HPA	4	24"	44,383	NA	46,312	NA

Hot Gas Defrost Models with PSC Open Drip Proof Rail Mount Motors - 460/1/60

Base Model	# of Fans	Fan Size (Inch)	List Price (\$US)			
			B0000	B0250, B0251, B0252, B0253	B0450, B0453, B0456, B0459	B0451, B0454, B0457, B0460
LEH0423MS6HPA	2	24"	22,627	NA	24,254	NA
LEH0513MS6HPA	2	24"	26,390	NA	28,017	NA
LEH0573MS6HPA	3	24"	28,537	NA	30,164	NA
LEH0713MS6HPA	3	24"	33,910	NA	35,537	NA
LEH0763MS6HPA	4	24"	40,358	NA	42,287	NA
LEH0963MS6HPA	4	24"	44,921	NA	46,850	NA
LEH0373MS4HPA	2	24"	21,291	NA	22,918	NA
LEH0473MS4HPA	2	24"	25,857	NA	27,484	NA
LEH0513MS4HPA	3	24"	28,270	NA	29,897	NA
LEH0653MS4HPA	3	24"	31,487	NA	33,114	NA
LEH0693MS4HPA	4	24"	33,910	NA	35,839	NA
LEH0883MS4HPA	4	24"	44,383	NA	46,312	NA



PREFERRED OPTION PACKAGES

intelliGen™				Standard Base +				TXV + Solenoid			
R-404A	R-448A/R-449A	R-407A/F	R-407C	R-404A	R-448A/R-449A	R-407A/F	R-407C	R-404A	R-448A/R-449A	R-407A/F	R-407C
B0250	B0251	B0252	B0253	B0450	B0453	B0456	B0459	B0451	B0454	B0457	B0460

HOT GAS DEFROST PREFERRED MODELS

Hot Gas Defrost Models with 3 Phase AC Totally Enclosed Rail Mount Motors - 208-230/3/60

Base Model	# of Fans	Fan Size (Inch)	List Price (\$US)			
			B0000	B0250, B0251, B0252, B0253	B0450, B0453, B0456, B0459	B0451, B0454, B0457, B0460
LEH0423CS6HTA	2	24"	24,187	NA	25,814	NA
LEH0513CS6HTA	2	24"	27,953	NA	29,580	NA
LEH0573CS6HTA	3	24"	30,876	NA	32,503	NA
LEH0713CS6HTA	3	24"	36,250	NA	37,877	NA
LEH0763CS6HTA	4	24"	43,475	NA	45,404	NA
LEH0963CS6HTA	4	24"	48,039	NA	49,968	NA
LEH0373CS4HTA	2	24"	22,848	NA	24,475	NA
LEH0473CS4HTA	2	24"	27,416	NA	29,043	NA
LEH0513CS4HTA	3	24"	30,609	NA	32,236	NA
LEH0653CS4HTA	3	24"	33,825	NA	35,452	NA
LEH0693CS4HTA	4	24"	37,027	NA	38,956	NA
LEH0883CS4HTA	4	24"	47,501	NA	49,430	NA
LEH1123CS6HTA	3	30"	48,885	NA	50,814	NA
LEH1343CS6HTA	3	30"	56,131	NA	58,060	NA
LEH1563CS6HTA	3	30"	61,502	NA	63,883	NA
LEH1823CS6HTA	3	30"	75,199	NA	77,580	NA
LEH2333CS6HTA	4	30"	94,712	NA	97,093	NA
LEH0983CS4HTA	3	30"	48,885	NA	50,814	NA
LEH1163CS4HTA	3	30"	55,060	NA	56,989	NA
LEH1343CS4HTA	3	30"	61,502	NA	63,883	NA
LEH1583CS4HTA	3	30"	76,810	NA	79,191	NA
LEH2053CS4HTA	4	30"	93,106	NA	95,487	NA



PREFERRED OPTION PACKAGES

intelliGen™				Standard Base +				TXV + Solenoid			
R-404A	R-448A/R-449A	R-407A/F	R-407C	R-404A	R-448A/R-449A	R-407A/F	R-407C	R-404A	R-448A/R-449A	R-407A/F	R-407C
B0250	B0251	B0252	B0253	B0450	B0453	B0456	B0459	B0451	B0454	B0457	B0460

HOT GAS DEFROST PREFERRED MODELS

Hot Gas Defrost Models with 3 Phase AC Totally Enclosed Rail Mount Motors - 380-400/3/50

Base Model	# of Fans	Fan Size (Inch)	List Price (\$US)			
			B0000	B0250, B0251, B0252, B0253	B0450, B0453, B0456, B0459	B0451, B0454, B0457, B0460
LEH0423XS6HTA	2	24"	24,187	NA	25,814	NA
LEH0513XS6HTA	2	24"	27,953	NA	29,580	NA
LEH0573XS6HTA	3	24"	30,876	NA	32,503	NA
LEH0713XS6HTA	3	24"	36,250	NA	37,877	NA
LEH0763XS6HTA	4	24"	43,475	NA	45,404	NA
LEH0963XS6HTA	4	24"	48,039	NA	49,968	NA
LEH0373XS4HTA	2	24"	22,848	NA	24,475	NA
LEH0473XS4HTA	2	24"	27,416	NA	29,043	NA
LEH0513XS4HTA	3	24"	30,609	NA	32,236	NA
LEH0653XS4HTA	3	24"	33,825	NA	35,452	NA
LEH0693XS4HTA	4	24"	37,027	NA	38,956	NA
LEH0883XS4HTA	4	24"	47,501	NA	49,430	NA
LEH1123XS6HTA	3	30"	48,885	NA	50,814	NA
LEH1343XS6HTA	3	30"	56,131	NA	58,060	NA
LEH1563XS6HTA	3	30"	61,502	NA	63,883	NA
LEH1823XS6HTA	3	30"	75,199	NA	77,580	NA
LEH2333XS6HTA	4	30"	94,712	NA	97,093	NA
LEH0983XS4HTA	3	30"	48,885	NA	50,814	NA
LEH1163XS4HTA	3	30"	55,060	NA	56,989	NA
LEH1343XS4HTA	3	30"	61,502	NA	63,883	NA
LEH1583XS4HTA	3	30"	76,810	NA	79,191	NA
LEH2053XS4HTA	4	30"	93,106	NA	95,487	NA



PREFERRED OPTION PACKAGES

intelliGen™				Standard Base +				TXV + Solenoid			
R-404A	R-448A/R-449A	R-407A/F	R-407C	R-404A	R-448A/R-449A	R-407A/F	R-407C	R-404A	R-448A/R-449A	R-407A/F	R-407C
B0250	B0251	B0252	B0253	B0450	B0453	B0456	B0459	B0451	B0454	B0457	B0460

HOT GAS DEFROST PREFERRED MODELS

Hot Gas Defrost Models with 3 Phase AC Totally Enclosed Rail Mount Motors - 460/3/60

Base Model	# of Fans	Fan Size (Inch)	List Price (\$US)			
			B0000	B0250, B0251, B0252, B0253	B0450, B0453, B0456, B0459	B0451, B0454, B0457, B0460
LEH0423DS6HTA	2	24"	24,187	NA	25,814	NA
LEH0513DS6HTA	2	24"	27,953	NA	29,580	NA
LEH0573DS6HTA	3	24"	30,876	NA	32,503	NA
LEH0713DS6HTA	3	24"	36,250	NA	37,877	NA
LEH0763DS6HTA	4	24"	43,475	NA	45,404	NA
LEH0963DS6HTA	4	24"	48,039	NA	49,968	NA
LEH0373DS4HTA	2	24"	22,848	NA	24,475	NA
LEH0473DS4HTA	2	24"	27,416	NA	29,043	NA
LEH0513DS4HTA	3	24"	30,609	NA	32,236	NA
LEH0653DS4HTA	3	24"	33,825	NA	35,452	NA
LEH0693DS4HTA	4	24"	37,027	NA	38,956	NA
LEH0883DS4HTA	4	24"	47,501	NA	49,430	NA
LEH1123DS6HTA	3	30"	48,885	NA	50,814	NA
LEH1343DS6HTA	3	30"	56,131	NA	58,060	NA
LEH1563DS6HTA	3	30"	61,502	NA	63,883	NA
LEH1823DS6HTA	3	30"	75,199	NA	77,580	NA
LEH2333DS6HTA	4	30"	94,712	NA	97,093	NA
LEH0983DS4HTA	3	30"	48,885	NA	50,814	NA
LEH1163DS4HTA	3	30"	55,060	NA	56,989	NA
LEH1343DS4HTA	3	30"	61,502	NA	63,883	NA
LEH1583DS4HTA	3	30"	76,810	NA	79,191	NA
LEH2053DS4HTA	4	30"	93,106	NA	95,487	NA



PREFERRED OPTION PACKAGES

intelliGen™				Standard Base +				TXV + Solenoid			
R-404A	R-448A/R-449A	R-407A/F	R-407C	TXV				TXV + Solenoid			
B0250	B0251	B0252	B0253	R-404A	R-448A/R-449A	R-407A/F	R-407C	R-404A	R-448A/R-449A	R-407A/F	R-407C
B0250	B0251	B0252	B0253	B0450	B0453	B0456	B0459	B0451	B0454	B0457	B0460

HOT GAS DEFROST PREFERRED MODELS

Hot Gas Defrost Models with 3 Phase AC Totally Enclosed Rail Mount Motors - 575/3/60

Base Model	# of Fans	Fan Size (Inch)	List Price (\$US)			
			B0000	B0250, B0251, B0252, B0253	B0450, B0453, B0456, B0459	B0451, B0454, B0457, B0460
LEH0423ES6HTA	2	24"	24,305	NA	25,932	NA
LEH0513ES6HTA	2	24"	28,140	NA	29,767	NA
LEH0573ES6HTA	3	24"	31,017	NA	32,644	NA
LEH0713ES6HTA	3	24"	36,495	NA	38,122	NA
LEH0763ES6HTA	4	24"	43,617	NA	45,546	NA
LEH0963ES6HTA	4	24"	48,286	NA	50,215	NA
LEH0373ES4HTA	2	24"	22,933	NA	24,560	NA
LEH0473ES4HTA	2	24"	27,595	NA	29,222	NA
LEH0513ES4HTA	3	24"	30,741	NA	32,368	NA
LEH0653ES4HTA	3	24"	34,026	NA	35,653	NA
LEH0693ES4HTA	4	24"	37,041	NA	38,970	NA
LEH0883ES4HTA	4	24"	47,720	NA	49,649	NA
LEH1823ES6HTA	3	30"	76,703	NA	79,084	NA
LEH2333ES6HTA	4	30"	96,605	NA	98,986	NA
LEH1583ES4HTA	3	30"	78,347	NA	80,728	NA
LEH2053ES4HTA	4	30"	94,967	NA	97,348	NA



PREFERRED OPTION PACKAGES

intelliGen™				Standard Base +				TXV + Solenoid			
R-404A	R-448A/R-449A	R-407A/F	R-407C	R-404A	R-448A/R-449A	R-407A/F	R-407C	R-404A	R-448A/R-449A	R-407A/F	R-407C
B0250	B0251	B0252	B0253	B0450	B0453	B0456	B0459	B0451	B0454	B0457	B0460

HOT GAS DEFROST PREFERRED MODELS

Hot Gas Defrost Models with 3 Phase AC Open Drip Proof Rail Mount Motors - 208-230/3/60

Base Model	# of Fans	Fan Size (Inch)	List Price (\$US)			
			B0000	B0250, B0251, B0252, B0253	B0450, B0453, B0456, B0459	B0451, B0454, B0457, B0460
LEH0423CS6HYA	2	24"	23,840	NA	25,467	NA
LEH0513CS6HYA	2	24"	27,598	NA	29,225	NA
LEH0573CS6HYA	3	24"	30,420	NA	32,047	NA
LEH0713CS6HYA	3	24"	35,787	NA	37,414	NA
LEH0763CS6HYA	4	24"	42,774	NA	44,703	NA
LEH0963CS6HYA	4	24"	47,332	NA	49,261	NA
LEH0373CS4HYA	2	24"	22,496	NA	24,123	NA
LEH0473CS4HYA	2	24"	27,067	NA	28,694	NA
LEH0513CS4HYA	3	24"	30,150	NA	31,777	NA
LEH0653CS4HYA	3	24"	33,369	NA	34,996	NA
LEH0693CS4HYA	4	24"	36,326	NA	38,255	NA
LEH0883CS4HYA	4	24"	46,792	NA	48,721	NA
LEH1123CS6HYA	3	30"	47,532	NA	49,461	NA
LEH1343CS6HYA	3	30"	54,777	NA	56,706	NA
LEH1563CS6HYA	3	30"	60,149	NA	62,530	NA
LEH1823CS6HYA	3	30"	73,847	NA	76,228	NA
LEH2333CS6HYA	4	30"	92,907	NA	95,288	NA
LEH0983CS4HYA	3	30"	47,532	NA	49,461	NA
LEH1163CS4HYA	3	30"	53,706	NA	55,635	NA
LEH1343CS4HYA	3	30"	60,149	NA	62,530	NA
LEH1583CS4HYA	3	30"	75,458	NA	77,839	NA
LEH2053CS4HYA	4	30"	91,301	NA	93,682	NA



PREFERRED OPTION PACKAGES

intelliGen™				Standard Base +				TXV + Solenoid			
R-404A	R-448A/R-449A	R-407A/F	R-407C	R-404A	R-448A/R-449A	R-407A/F	R-407C	R-404A	R-448A/R-449A	R-407A/F	R-407C
B0250	B0251	B0252	B0253	B0450	B0453	B0456	B0459	B0451	B0454	B0457	B0460

HOT GAS DEFROST PREFERRED MODELS

Hot Gas Defrost Models with 3 Phase AC Open Drip Proof Rail Mount Motors - 380-400/3/50

Base Model	# of Fans	Fan Size (Inch)	List Price (\$US)			
			B0000	B0250, B0251, B0252, B0253	B0450, B0453, B0456, B0459	B0451, B0454, B0457, B0460
LEH0423XS6HYA	2	24"	23,840	NA	25,467	NA
LEH0513XS6HYA	2	24"	27,598	NA	29,225	NA
LEH0573XS6HYA	3	24"	30,420	NA	32,047	NA
LEH0713XS6HYA	3	24"	35,787	NA	37,414	NA
LEH0763XS6HYA	4	24"	42,774	NA	44,703	NA
LEH0963XS6HYA	4	24"	47,332	NA	49,261	NA
LEH0373XS4HYA	2	24"	22,496	NA	24,123	NA
LEH0473XS4HYA	2	24"	27,067	NA	28,694	NA
LEH0513XS4HYA	3	24"	30,150	NA	31,777	NA
LEH0653XS4HYA	3	24"	33,369	NA	34,996	NA
LEH0693XS4HYA	4	24"	36,326	NA	38,255	NA
LEH0883XS4HYA	4	24"	46,792	NA	48,721	NA
LEH1563XS6HYA	3	30"	60,149	NA	62,530	NA
LEH1823XS6HYA	3	30"	73,847	NA	76,228	NA
LEH2333XS6HYA	4	30"	92,907	NA	95,288	NA
LEH1343XS4HYA	3	30"	60,149	NA	62,530	NA
LEH1583XS4HYA	3	30"	75,458	NA	77,839	NA
LEH2053XS4HYA	4	30"	91,301	NA	93,682	NA



PREFERRED OPTION PACKAGES

Standard Base +											
intelliGen™				TXV				TXV + Solenoid			
R-404A	R-448A/R-449A	R-407A/F	R-407C	R-404A	R-448A/R-449A	R-407A/F	R-407C	R-404A	R-448A/R-449A	R-407A/F	R-407C
B0250	B0251	B0252	B0253	B0450	B0453	B0456	B0459	B0451	B0454	B0457	B0460

HOT GAS DEFROST PREFERRED MODELS

Hot Gas Defrost Models with 3 Phase AC Open Drip Proof Rail Mount Motors - 460/3/60

Base Model	# of Fans	Fan Size (Inch)	List Price (\$US)			
			B0000	B0250, B0251, B0252, B0253	B0450, B0453, B0456, B0459	B0451, B0454, B0457, B0460
LEH0423DS6HYA	2	24"	23,840	NA	25,467	NA
LEH0513DS6HYA	2	24"	27,598	NA	29,225	NA
LEH0573DS6HYA	3	24"	30,420	NA	32,047	NA
LEH0713DS6HYA	3	24"	35,787	NA	37,414	NA
LEH0763DS6HYA	4	24"	42,774	NA	44,703	NA
LEH0963DS6HYA	4	24"	47,332	NA	49,261	NA
LEH0373DS4HYA	2	24"	22,496	NA	24,123	NA
LEH0473DS4HYA	2	24"	27,067	NA	28,694	NA
LEH0513DS4HYA	3	24"	30,150	NA	31,777	NA
LEH0653DS4HYA	3	24"	33,369	NA	34,996	NA
LEH0693DS4HYA	4	24"	36,326	NA	38,255	NA
LEH0883DS4HYA	4	24"	46,792	NA	48,721	NA
LEH1123DS6HYA	3	30"	47,532	NA	49,461	NA
LEH1343DS6HYA	3	30"	54,777	NA	56,706	NA
LEH1563DS6HYA	3	30"	60,149	NA	62,530	NA
LEH1823DS6HYA	3	30"	73,847	NA	76,228	NA
LEH2333DS6HYA	4	30"	92,907	NA	95,288	NA
LEH0983DS4HYA	3	30"	47,532	NA	49,461	NA
LEH1163DS4HYA	3	30"	53,706	NA	55,635	NA
LEH1343DS4HYA	3	30"	60,149	NA	62,530	NA
LEH1583DS4HYA	3	30"	75,458	NA	77,839	NA
LEH2053DS4HYA	4	30"	91,301	NA	93,682	NA



PREFERRED OPTION PACKAGES

Standard Base +											
intelliGen™				TXV				TXV + Solenoid			
R-404A	R-448A/R-449A	R-407A/F	R-407C	R-404A	R-448A/R-449A	R-407A/F	R-407C	R-404A	R-448A/R-449A	R-407A/F	R-407C
B0250	B0251	B0252	B0253	B0450	B0453	B0456	B0459	B0451	B0454	B0457	B0460

HOT GAS DEFROST PREFERRED MODELS

Hot Gas Defrost Models with 3 Phase AC Open Drip Proof Rail Mount Motors - 575/3/60

Base Model	# of Fans	Fan Size (Inch)	List Price (\$US)			
			B0000	B0250, B0251, B0252, B0253	B0450, B0453, B0456, B0459	B0451, B0454, B0457, B0460
LEH1123ES6HYA	3	30"	48,420	NA	50,349	NA
LEH1343ES6HYA	3	30"	55,875	NA	57,804	NA
LEH1563ES6HYA	3	30"	61,354	NA	63,735	NA
LEH0983ES4HYA	3	30"	48,479	NA	50,408	NA
LEH1163ES4HYA	3	30"	54,777	NA	56,706	NA
LEH1343ES4HYA	3	30"	61,354	NA	63,735	NA

Hot Gas Defrost Models with Variable Speed EC Rail Mount Motors - 208-230/3/60

Base Model	# of Fans	Fan Size (Inch)	List Price (\$US)			
			B0000	B0250, B0251, B0252, B0253	B0450, B0453, B0456, B0459	B0451, B0454, B0457, B0460
LEH0423CS6HVA	2	24"	36,605	NA	38,232	NA
LEH0513CS6HVA	2	24"	40,362	NA	41,989	NA
LEH0573CS6HVA	3	24"	49,566	NA	51,193	NA
LEH0713CS6HVA	3	24"	54,932	NA	56,559	NA
LEH0763CS6HVA	4	24"	68,301	NA	70,230	NA
LEH0963CS6HVA	4	24"	72,860	NA	74,789	NA
LEH0373CS4HVA	2	24"	35,260	NA	36,887	NA
LEH0473CS4HVA	2	24"	39,832	NA	41,459	NA
LEH0513CS4HVA	3	24"	49,298	NA	50,925	NA
LEH0653CS4HVA	3	24"	52,517	NA	54,144	NA
LEH0693CS4HVA	4	24"	61,855	NA	63,784	NA
LEH0883CS4HVA	4	24"	72,321	NA	74,250	NA
LEH1123CS6HVA	3	30"	74,446	NA	76,375	NA
LEH1343CS6HVA	3	30"	85,795	NA	87,724	NA
LEH1563CS6HVA	3	30"	94,207	NA	96,588	NA
LEH1823CS6HVA	3	30"	115,660	NA	118,041	NA
LEH2333CS6HVA	4	30"	145,513	NA	147,894	NA
LEH0983CS4HVA	3	30"	74,446	NA	76,375	NA
LEH1163CS4HVA	3	30"	84,116	NA	86,045	NA
LEH1343CS4HVA	3	30"	94,207	NA	96,588	NA
LEH1583CS4HVA	3	30"	118,182	NA	120,563	NA
LEH2053CS4HVA	4	30"	142,998	NA	145,379	NA



PREFERRED OPTION PACKAGES

intelliGen™				Standard Base +				TXV + Solenoid			
R-404A	R-448A/R-449A	R-407A/F	R-407C	R-404A	R-448A/R-449A	R-407A/F	R-407C	R-404A	R-448A/R-449A	R-407A/F	R-407C
B0250	B0251	B0252	B0253	B0450	B0453	B0456	B0459	B0451	B0454	B0457	B0460

HOT GAS DEFROST PREFERRED MODELS

Hot Gas Defrost Models with Variable Speed EC Rail Mount Motors - 460/3/60

Base Model	# of Fans	Fan Size (Inch)	List Price (\$US)			
			B0000	B0250, B0251, B0252, B0253	B0450, B0453, B0456, B0459	B0451, B0454, B0457, B0460
LEH0423DS6HVA	2	24"	36,605	NA	38,232	NA
LEH0513DS6HVA	2	24"	40,362	NA	41,989	NA
LEH0573DS6HVA	3	24"	49,566	NA	51,193	NA
LEH0713DS6HVA	3	24"	54,932	NA	56,559	NA
LEH0763DS6HVA	4	24"	68,301	NA	70,230	NA
LEH0963DS6HVA	4	24"	72,860	NA	74,789	NA
LEH0373DS4HVA	2	24"	35,260	NA	36,887	NA
LEH0473DS4HVA	2	24"	39,832	NA	41,459	NA
LEH0513DS4HVA	3	24"	49,298	NA	50,925	NA
LEH0653DS4HVA	3	24"	52,517	NA	54,144	NA
LEH0693DS4HVA	4	24"	61,855	NA	63,784	NA
LEH0883DS4HVA	4	24"	72,321	NA	74,250	NA
LEH1123DS6HVA	3	30"	75,396	NA	77,325	NA
LEH1343DS6HVA	3	30"	86,890	NA	88,819	NA
LEH1563DS6HVA	3	30"	95,410	NA	97,791	NA
LEH1823DS6HVA	3	30"	117,136	NA	119,517	NA
LEH2333DS6HVA	4	30"	147,371	NA	149,752	NA
LEH0983DS4HVA	3	30"	75,396	NA	77,325	NA
LEH1163DS4HVA	3	30"	85,190	NA	87,119	NA
LEH1343DS4HVA	3	30"	95,410	NA	97,791	NA
LEH1583DS4HVA	3	30"	119,691	NA	122,072	NA
LEH2053DS4HVA	4	30"	144,824	NA	147,205	NA



PREFERRED OPTION PACKAGES

intelliGen™				Standard Base +				TXV + Solenoid			
R-404A	R-448A/R-449A	R-407A/F	R-407C	R-404A	R-448A/R-449A	R-407A/F	R-407C	R-404A	R-448A/R-449A	R-407A/F	R-407C
B0250	B0251	B0252	B0253	B0450	B0453	B0456	B0459	B0451	B0454	B0457	B0460

HOT GAS DEFROST PREFERRED MODELS

Hot Gas Defrost Models with High CFM Rail Mount Motors - 208-230/3/60

Base Model	# of Fans	Fan Size (Inch)	List Price (\$US)			
			B0000	B0250, B0251, B0252, B0253	B0450, B0453, B0456, B0459	B0451, B0454, B0457, B0460
LEH0423CS6HHA	2	24"	27,327	NA	28,954	NA
LEH0513CS6HHA	2	24"	31,092	NA	32,719	NA
LEH0573CS6HHA	3	24"	35,584	NA	37,211	NA
LEH0713CS6HHA	3	24"	40,956	NA	42,583	NA
LEH0763CS6HHA	4	24"	49,755	NA	51,684	NA
LEH0963CS6HHA	4	24"	54,315	NA	56,244	NA
LEH0373CS4HHA	2	24"	25,992	NA	27,619	NA
LEH0473CS4HHA	2	24"	30,554	NA	32,181	NA
LEH0513CS4HHA	3	24"	35,316	NA	36,943	NA
LEH0653CS4HHA	3	24"	38,532	NA	40,159	NA
LEH0693CS4HHA	4	24"	43,304	NA	45,233	NA
LEH0883CS4HHA	4	24"	53,778	NA	55,707	NA
LEH1123CS6HHA	3	30"	54,127	NA	56,056	NA
LEH1343CS6HHA	3	30"	61,373	NA	63,302	NA
LEH1563CS6HHA	3	30"	66,743	NA	69,124	NA
LEH1823CS6HHA	3	30"	80,441	NA	82,822	NA
LEH2333CS6HHA	4	30"	101,700	NA	104,081	NA
LEH0983CS4HHA	3	30"	54,127	NA	56,056	NA
LEH1163CS4HHA	3	30"	60,301	NA	62,230	NA
LEH1343CS4HHA	3	30"	66,743	NA	69,124	NA
LEH1583CS4HHA	3	30"	82,052	NA	84,433	NA
LEH2053CS4HHA	4	30"	100,094	NA	102,475	NA



PREFERRED OPTION PACKAGES

intelliGen™				Standard Base +				TXV + Solenoid			
R-404A	R-448A/R-449A	R-407A/F	R-407C	R-404A	R-448A/R-449A	R-407A/F	R-407C	R-404A	R-448A/R-449A	R-407A/F	R-407C
B0250	B0251	B0252	B0253	B0450	B0453	B0456	B0459	B0451	B0454	B0457	B0460

HOT GAS DEFROST PREFERRED MODELS

Hot Gas Defrost Models with High CFM Rail Mount Motors - 460/3/60

Base Model	# of Fans	Fan Size (Inch)	List Price (\$US)			
			B0000	B0250, B0251, B0252, B0253	B0450, B0453, B0456, B0459	B0451, B0454, B0457, B0460
LEH0423DS6HHA	2	24"	27,327	NA	28,954	NA
LEH0513DS6HHA	2	24"	31,092	NA	32,719	NA
LEH0573DS6HHA	3	24"	35,584	NA	37,211	NA
LEH0713DS6HHA	3	24"	40,956	NA	42,583	NA
LEH0763DS6HHA	4	24"	49,755	NA	51,684	NA
LEH0963DS6HHA	4	24"	54,315	NA	56,244	NA
LEH0373DS4HHA	2	24"	25,992	NA	27,619	NA
LEH0473DS4HHA	2	24"	30,554	NA	32,181	NA
LEH0513DS4HHA	3	24"	35,316	NA	36,943	NA
LEH0653DS4HHA	3	24"	38,532	NA	40,159	NA
LEH0693DS4HHA	4	24"	43,304	NA	45,233	NA
LEH0883DS4HHA	4	24"	53,778	NA	55,707	NA
LEH1123DS6HHA	3	30"	54,127	NA	56,056	NA
LEH1343DS6HHA	3	30"	61,373	NA	63,302	NA
LEH1563DS6HHA	3	30"	66,743	NA	69,124	NA
LEH1823DS6HHA	3	30"	80,441	NA	82,822	NA
LEH2333DS6HHA	4	30"	101,700	NA	104,081	NA
LEH0983DS4HHA	3	30"	54,127	NA	56,056	NA
LEH1163DS4HHA	3	30"	60,301	NA	62,230	NA
LEH1343DS4HHA	3	30"	66,743	NA	69,124	NA
LEH1583DS4HHA	3	30"	82,052	NA	84,433	NA
LEH2053DS4HHA	4	30"	100,094	NA	102,475	NA



FACTORY INSTALLED: A LA CARTE OPTION PACKAGES

Refer to page 84 for Factory Installed: Preferred Option Packages.

Air Defrost

Base Model	# of Fans	Fan Size (Inch)	List Price Adder (\$US)							
			Electrical Options						Mechanical Options	
			intelliGen™	intelliGen Cards			Mech. Room T'stat	Electric Room T'stat	TXV	TXV & LLSV
	Webserver Card	Multi-system Card (MSC)	Integration Card							
LEH0553*S6A^A	2	24"	8,303	1,089	1,545	618	506	783	1,713	2,664
LEH0570*S6A^A	2	24"	8,303	1,089	1,545	618	506	783	1,713	2,664
LEH0700*S6AMA	2	24"	8,303	1,089	1,545	618	506	783	1,713	2,664
LEH0723*S6A^A	2	24"	8,303	1,089	1,545	618	506	783	1,713	2,664
LEH0743*S6A^A	3	24"	8,303	1,089	1,545	618	506	783	1,713	2,664
LEH0755*S6AMA	2	24"	8,303	1,089	1,545	618	506	783	1,713	2,664
LEH0900*S6A^A	3	24"	8,303	1,089	1,545	618	506	783	1,713	2,664
LEH0933*S6A^A	3	24"	8,303	1,089	1,545	618	506	783	1,713	2,664
LEH1053*S6A^A	4	24"	8,303	1,089	1,545	618	506	783	2,031	3,218
LEH1080*S6AMA	3	24"	8,303	1,089	1,545	618	506	783	1,713	2,664
LEH1245*S6AMA	3	24"	8,303	1,089	1,545	618	506	783	1,713	2,664
LEH1313*S6A^A	4	24"	8,303	1,089	1,545	618	506	783	2,031	3,218
LEH1445*S6AMA	4	24"	8,303	1,089	1,545	618	506	783	2,031	3,218
LEH1655*S6AMA	4	24"	8,303	1,089	1,545	618	506	783	2,031	3,218
LEH0620*S6AMA	1	30"	8,303	1,089	1,545	618	Call	783	2,506	3,546
LEH0730*S6AMA	1	30"	8,303	1,089	1,545	618	Call	783	2,222	3,546
LEH0840*S8AMA	1	30"	8,303	1,089	1,545	618	Call	783	2,222	3,546
LEH1250*S6AMA	2	30"	8,303	1,089	1,545	618	Call	783	2,506	3,546
LEH1333*S6A^A	3	30"	8,303	1,089	1,545	618	Call	783	2,031	3,218
LEH1470*S6AMA	2	30"	8,303	1,089	1,545	618	Call	783	2,222	3,546
LEH1623*S6A^A	3	30"	8,303	1,089	1,545	618	Call	783	2,031	3,218
LEH1870*S6AMA	3	30"	8,303	1,089	1,545	618	Call	783	2,905	4,111
LEH1873*S6A^A	3	30"	8,303	1,089	1,545	618	Call	783	2,506	3,546
LEH2200*S6AMA	3	30"	8,303	1,089	1,545	618	Call	783	2,358	3,762
LEH2203*S6A^A	3	30"	8,303	1,089	1,545	618	Call	783	2,222	3,546
LEH2553*S6A^A	4	30"	8,303	1,089	1,545	618	Call	783	2,222	3,546
LEH2883*S6A^A	4	30"	Call	1,089	1,545	618	Call	783	2,222	3,546
LEH2513*S8A^A	3	30"	8,303	1,089	1,545	618	Call	783	2,222	3,546
LEH2953*S8A^A	4	30"	Call	1,089	1,545	618	Call	783	2,222	3,546
LEH3283*S8A^A	4	30"	Call	1,089	1,545	618	Call	783	2,222	3,546

- Note**
- Call for Adj. Defrost Term./Fan Delay
 - Call for QCF, TXV, & LLSV
 - * = Voltage (B = 208-230/1/60, C = 208-230/3/60, M = 460/1/60, D = 460/3/60, E = 575/3/60, X = 380-400/3/50)
 - ^ = Motor (M = 2-Speed EC, Y = 3 Phase AC Open Drip Proof Rail Mount, T = 3 Phase AC Totally Enclosed Rail Mount, P = PSC Open Drip Proof Rail Mount, V = Variable Speed EC Rail Mount)



FACTORY INSTALLED: A LA CARTE OPTION PACKAGES

Refer to page 84 for Factory Installed: Preferred Option Packages.

Air Defrost

Base Model	# of Fans	Fan Size (Inch)	List Price Adder (\$US)							
			†Coil Options			Cabinet & Drain Pan Options				
			ProKote	Bronz Glow or ElectroFin	Copper Coil	Stainless Drain Pan and Stainless Cabinet	Insulated Drain Pan	Stainless Steel Drain Pan	^Stainless Insulated Drain Pan	Stainless Steel Cabinet
LEH0553*S6A^A	2	24"	2,273	6,546	9,503	5,772	1,286	2,131	4,089	3,641
LEH0570*S6A^A	2	24"	2,273	6,546	9,503	5,772	1,286	2,131	4,089	3,641
LEH0700*S6AMA	2	24"	2,273	6,546	9,503	5,772	1,286	2,131	4,089	3,641
LEH0723*S6A^A	2	24"	2,273	6,757	10,556	5,772	1,286	2,131	4,089	3,641
LEH0743*S6A^A	3	24"	2,413	8,090	12,803	7,879	1,440	2,431	4,474	5,448
LEH0755*S6AMA	2	24"	2,273	6,757	10,556	5,772	1,286	2,131	4,089	3,641
LEH0900*S6A^A	3	24"	2,413	8,090	12,803	7,879	1,440	2,431	4,474	5,448
LEH0933*S6A^A	3	24"	2,413	8,090	13,861	7,879	1,440	2,431	4,474	5,448
LEH1053*S6A^A	4	24"	2,595	9,910	14,917	9,529	1,545	2,959	5,730	6,570
LEH1080*S6AMA	3	24"	2,413	8,090	12,803	7,879	1,440	2,431	4,474	5,448
LEH1245*S6AMA	3	24"	2,413	8,090	13,861	7,879	1,440	2,431	4,474	5,448
LEH1313*S6A^A	4	24"	2,595	9,910	16,367	9,529	1,545	2,959	5,730	6,570
LEH1445*S6AMA	4	24"	2,595	9,910	14,917	9,529	1,545	2,959	5,730	6,570
LEH1655*S6AMA	4	24"	2,595	9,910	16,367	9,529	1,545	2,959	5,730	6,570
LEH0620*S6AMA	1	30"	925	4,179	8,404	7,623	640	991	1,246	6,632
LEH0730*S6AMA	1	30"	1,490	5,218	9,899	7,623	640	991	1,246	6,632
LEH0840*S8AMA	1	30"	1,490	5,218	9,899	7,623	640	991	1,246	6,632
LEH1250*S6AMA	2	30"	1,851	8,356	16,805	15,246	1,278	1,983	2,492	13,263
LEH1333*S6A^A	3	30"	2,777	11,487	21,251	17,713	1,865	2,974	3,739	14,739
LEH1470*S6AMA	2	30"	2,980	10,435	19,800	15,246	1,278	1,983	2,492	13,263
LEH1623*S6A^A	3	30"	2,777	11,487	23,895	0	1,865	NA	NA	14,739
LEH1870*S6AMA	3	30"	2,860	12,911	25,965	0	1,991	NA	NA	20,492
LEH1873*S6A^A	3	30"	2,777	12,535	25,209	0	1,933	NA	NA	19,895
LEH2200*S6AMA	3	30"	4,470	15,653	29,699	0	1,933	NA	NA	19,895
LEH2203*S6A^A	3	30"	4,470	15,653	29,699	0	1,933	NA	NA	19,895
LEH2553*S6A^A	4	30"	4,470	17,760	32,207	0	2,163	NA	NA	NA
LEH2883*S6A^A	4	30"	4,470	19,890	37,353	0	2,163	NA	NA	NA
LEH2513*S8A^A	3	30"	3,285	16,384	32,864	0	2,163	NA	NA	NA
LEH2953*S8A^A	4	30"	3,643	18,610	Call	0	2,163	NA	NA	NA
LEH3283*S8A^A	4	30"	3,643	20,852	Call	0	2,163	NA	NA	NA

- Note**
- ^ Stainless insulated drain pan is not applicable for legacy 3 phase models with Variable Speed EC Rail Mount motor, 3 Phase AC Open Drip Proof Rail Mount and 3 Phase AC Totally Enclosed Rail Mount
 - † Call for Bohn-Kote
 - * = Voltage (B = 208-230/1/60, C = 208-230/3/60, M = 460/1/60, D = 460/3/60, E = 575/3/60, X = 380-400/3/50)
 - ^ = Motor (M = 2-Speed EC, Y = 3 Phase AC Open Drip Proof Rail Mount, T = 3 Phase AC Totally Enclosed Rail Mount, P = PSC Open Drip Proof Rail Mount, V = Variable Speed EC Rail Mount)



FACTORY INSTALLED: A LA CARTE OPTION PACKAGES

Refer to page 92 for Factory Installed: Preferred Option Packages.

Electric Defrost

Base Model	# of Fans	Fan Size (Inch)	List Price Adder (\$US)							
			Electrical Options						Mechanical Options	
			intelliGen™	intelliGen Cards			Mech. Room T'stat	Electric Room T'stat	TXV	TXV & LLSV
	Webserver Card	Multi-system Card (MSC)	Integration Card							
LEH0423*S6E^A	2	24"	8,303	1,089	1,545	618	506	783	1,713	2,664
LEH0540*S6EMA	2	24"	8,303	1,089	1,545	618	506	783	1,713	2,664
LEH0573*S6E^A	3	24"	8,303	1,089	1,545	618	506	783	1,713	2,664
LEH0630*S6EMA	2	24"	8,303	1,089	1,545	618	506	783	1,713	2,664
LEH0713*S6E^A	3	24"	8,303	1,089	1,545	618	506	783	1,713	2,664
LEH0763*S6E^A	4	24"	8,303	1,089	1,545	618	506	783	2,031	3,218
LEH0805*S6EMA	3	24"	8,303	1,089	1,545	618	506	783	1,713	2,664
LEH0925*S6EMA	3	24"	8,303	1,089	1,545	618	506	783	2,031	3,218
LEH0963*S6E^A	4	24"	8,303	1,089	1,545	618	506	783	2,031	3,218
LEH1125*S6EMA	4	24"	8,303	1,089	1,545	618	506	783	2,031	3,218
LEH1210*S6EMA	4	24"	8,303	1,089	1,545	618	506	783	2,031	3,218
LEH0373*S4E^A	2	24"	8,303	1,089	1,545	618	506	783	1,713	2,664
LEH0473*S4E^A	2	24"	8,303	1,089	1,545	618	506	783	1,713	2,664
LEH0480*S4EMA	2	24"	8,303	1,089	1,545	618	506	783	1,713	2,664
LEH0513*S4E^A	3	24"	8,303	1,089	1,545	618	506	783	1,713	2,664
LEH0565*S4EMA	2	24"	8,303	1,089	1,545	618	506	783	1,713	2,664
LEH0653*S4E^A	3	24"	8,303	1,089	1,545	618	506	783	1,713	2,664
LEH0693*S4E^A	4	24"	8,303	1,089	1,545	618	506	783	2,031	3,218
LEH0730*S4EMA	3	24"	8,303	1,089	1,545	618	506	783	1,713	2,664
LEH0845*S4EMA	3	24"	8,303	1,089	1,545	618	506	783	1,713	2,664
LEH0883*S4E^A	4	24"	8,303	1,089	1,545	618	506	783	2,031	3,218
LEH1010*S4EMA	4	24"	8,303	1,089	1,545	618	0	783	2,031	3,218
LEH1085*S4EMA	4	24"	8,303	1,089	1,545	618	506	783	2,031	3,218
LEH1123*S6E^A	3	30"	8,303	1,089	1,545	618	0	783	2,031	3,218
LEH1340*S6EMA	3	30"	8,303	1,089	1,545	618	0	783	2,155	3,414
LEH1343*S6E^A	3	30"	8,303	1,089	1,545	618	0	783	2,031	3,218
LEH1560*S6EMA	3	30"	8,303	1,089	1,545	618	0	783	2,506	0
LEH1563*S6E^A	3	30"	8,303	1,089	1,545	618	0	783	2,506	0
LEH1820*S6EMA	3	30"	8,303	1,089	1,545	618	0	783	2,658	3,546
LEH1823*S6E^A	3	30"	8,303	1,089	1,545	618	0	783	2,658	3,546
LEH2330*S6EMA	4	30"	8,303	1,089	1,545	618	0	783	2,155	3,762
LEH2333*S6E^A	4	30"	0	1,089	1,545	618	0	783	2,031	3,546
LEH0983*S4E^A	3	30"	8,303	1,089	1,545	618	0	783	2,031	3,218
LEH1163*S4E^A	3	30"	8,303	1,089	1,545	618	0	783	2,031	3,218
LEH1343*S4E^A	3	30"	8,303	1,089	1,545	618	0	783	2,506	3,218
LEH1583*S4E^A	3	30"	8,303	1,089	1,545	618	0	783	2,031	3,546
LEH2053*S4E^A	4	30"	8,303	1,089	1,545	618	0	783	2,031	3,546

Note

- Call for Adj. Defrost Term./Fan Delay
- Call for QCF, TXV, & LLSV
- * = Voltage (B = C = 208-230/3/60, D = 460/3/60, E = 575/3/60, X = 380-400/3/50)
- ^ = Motor (M = 2-Speed EC, Y = 3 Phase AC Open Drip Proof Rail Mount, T = 3 Phase AC Totally Enclosed Rail Mount, P = PSC Open Drip Proof Rail Mount, V = Variable Speed EC Rail Mount, H = High CFM Rail Mount)



FACTORY INSTALLED: A LA CARTE OPTION PACKAGES

Refer to page 92 for Factory Installed: Preferred Option Packages.

Electric Defrost

Base Model	# of Fans	Fan Size (Inch)	List Price Adder (\$US)				
			†Coil Options		TXV, LLS & T-Stat	Cabinet & Drain Pan Options	
			Bronz Glow or ElectroFin	†Copper Coil		Stainless Drain Pan and Stainless Cabinet	Insulated Drain Pan
LEH0423*S6E^A	2	24"	7,928	9,503	3,170	5,055	1,286
LEH0540*S6EMA	2	24"	7,928	10,556	3,170	5,055	1,286
LEH0573*S6E^A	3	24"	9,262	12,803	3,170	7,490	1,440
LEH0630*S6EMA	2	24"	7,928	10,556	3,170	5,055	1,286
LEH0713*S6E^A	3	24"	9,262	13,861	3,170	7,490	1,440
LEH0763*S6E^A	4	24"	11,084	14,917	3,724	7,961	1,545
LEH0805*S6EMA	3	24"	9,262	12,803	3,170	7,490	1,440
LEH0925*S6EMA	3	24"	11,084	13,861	3,724	7,490	1,440
LEH0963*S6E^A	4	24"	11,084	16,367	3,724	7,961	1,545
LEH1125*S6EMA	4	24"	11,084	14,917	3,724	7,961	1,545
LEH1210*S6EMA	4	24"	11,084	16,367	3,724	7,961	1,545
LEH0373*S4E^A	2	24"	7,928	NA	3,170	5,055	1,286
LEH0473*S4E^A	2	24"	7,928	NA	3,170	5,055	1,286
LEH0480*S4EMA	2	24"	7,928	NA	3,170	5,055	1,286
LEH0513*S4E^A	3	24"	9,262	NA	3,170	7,490	1,440
LEH0565*S4EMA	2	24"	7,928	NA	3,170	5,055	1,286
LEH0653*S4E^A	3	24"	9,262	NA	3,170	7,490	1,440
LEH0693*S4E^A	4	24"	11,084	NA	3,724	7,975	1,545
LEH0730*S4EMA	3	24"	9,262	NA	3,170	7,490	1,440
LEH0845*S4EMA	3	24"	9,262	NA	3,170	7,490	1,440
LEH0883*S4E^A	4	24"	11,084	NA	3,724	7,961	1,545
LEH1010*S4EMA	4	24"	11,084	NA	NA	7,975	1,545
LEH1085*S4EMA	4	24"	11,084	NA	3,724	7,961	1,545
LEH1123*S6E^A	3	30"	12,661	21,251	NA	14,418	1,865
LEH1340*S6EMA	3	30"	12,661	23,895	NA	14,418	1,865
LEH1343*S6E^A	3	30"	12,661	23,895	NA	14,418	1,865
LEH1560*S6EMA	3	30"	13,710	25,209	NA	18,644	1,865
LEH1563*S6E^A	3	30"	13,710	25,209	NA	18,644	1,865
LEH1820*S6EMA	3	30"	15,653	29,699	NA	19,895	1,933
LEH1823*S6E^A	3	30"	15,653	29,699	NA	19,895	1,933
LEH2330*S6EMA	4	30"	21,065	37,353	NA	0	2,163
LEH2333*S6E^A	4	30"	21,065	37,353	NA	0	2,163
LEH0983*S4E^A	3	30"	12,661	NA	NA	14,418	1,865
LEH1163*S4E^A	3	30"	12,661	NA	NA	14,418	1,865
LEH1343*S4E^A	3	30"	13,710	NA	NA	18,644	1,865
LEH1583*S4E^A	3	30"	16,828	NA	NA	0	1,933
LEH2053*S4E^A	4	30"	21,065	NA	NA	0	2,163

- Note**
- † Call for Bohn-Kote coil option
 - † Copper Coil is not applicable for models with 4 FPI or 2-Speed EC Motor (Motor Code M)
 - * = Voltage (B = C = 208-230/3/60, D = 460/3/60, E = 575/3/60, X = 380-400/3/50)
 - ^ = Motor (M = 2-Speed EC, Y = 3 Phase AC Open Drip Proof Rail Mount, T = 3 Phase AC Totally Enclosed Rail Mount, P = PSC Open Drip Proof Rail Mount, V = Variable Speed EC Rail Mount, H = High CFM Rail Mount)



FACTORY INSTALLED: A LA CARTE OPTION PACKAGES

Refer to page 106 for Factory Installed: Preferred Option Packages.

Hot Gas Defrost

Base Model	# of Fans	Fan Size (Inch)	List Price Adder (\$US)								
			Electrical Option	Mechanical Option	Coil Options		Hot Gas Loop	Drain Pan Options			Defrost Control Options
			Mech. Room T-stat	TXV	Bronz Glow or ElectroFin	Copper Coil		Stainless Drain Pan and Stainless Cabinet	Insulated Drain Pan	Stainless Steel Cabinet	Mohave Hot Gas
LEH0423*S6H^A	2	24"	506	1,713	6,757	9,503	958	5,055	1,286	5,055	2,647
LEH0513*S6H^A	2	24"	506	1,713	6,757	10,556	958	5,055	1,286	5,055	3,548
LEH0540*S6HMA	2	24"	506	1,713	6,757	10,556	958	5,055	1,286	5,055	2,647
LEH0573*S6H^A	3	24"	506	1,713	8,090	12,803	958	7,490	1,440	7,490	2,502
LEH0630*S6HMA	2	24"	506	1,713	6,757	10,556	958	5,055	1,286	5,055	3,548
LEH0713*S6H^A	3	24"	506	1,713	8,090	13,861	958	7,490	1,440	7,490	3,790
LEH0763*S6H^A	4	24"	506	2,031	9,910	14,917	958	7,961	1,545	7,961	4,782
LEH0805*S6HMA	3	24"	506	1,713	8,090	12,803	958	7,490	1,440	7,490	2,502
LEH0925*S6HMA	3	24"	506	2,031	8,090	13,861	958	7,490	1,440	7,490	3,790
LEH0963*S6H^A	4	24"	506	2,031	9,910	16,367	958	7,961	1,545	7,961	5,880
LEH1125*S6HMA	4	24"	506	2,031	9,910	14,917	958	7,961	1,545	7,961	4,782
LEH1210*S6HMA	4	24"	506	2,031	9,910	16,367	958	7,961	1,545	7,961	5,880
LEH0373*S4H^A	2	24"	506	1,713	6,757	NA	958	5,055	1,286	5,055	2,329
LEH0473*S4H^A	2	24"	506	1,713	6,757	NA	958	5,055	1,286	5,055	3,413
LEH0480*S4HMA	2	24"	506	1,713	6,757	NA	958	5,055	1,286	5,055	2,329
LEH0513*S4H^A	3	24"	506	1,713	8,090	NA	958	7,490	1,440	7,490	2,440
LEH0565*S4HMA	2	24"	506	1,713	6,757	NA	958	5,055	1,286	5,055	3,413
LEH0653*S4H^A	3	24"	506	1,713	8,090	NA	958	7,490	1,440	7,490	3,211
LEH0693*S4H^A	4	24"	506	2,031	9,910	NA	958	7,961	1,545	7,961	3,240
LEH0730*S4HMA	3	24"	506	1,713	8,090	NA	958	7,490	1,440	7,490	2,440
LEH0845*S4HMA	3	24"	506	1,713	8,090	NA	958	7,490	1,440	7,490	3,211
LEH0883*S4H^A	4	24"	506	2,031	9,910	NA	958	7,961	1,545	7,961	5,752
LEH1010*S4HMA	4	24"	506	2,031	9,910	NA	958	7,975	1,545	7,975	3,240
LEH1085*S4HMA	4	24"	506	2,031	9,910	NA	958	7,961	1,545	7,961	5,752
LEH1123*S6H^A	3	30"	0	2,031	11,487	20,635	1,712	14,418	1,865	14,418	Call
LEH1340*S6HMA	3	30"	0	2,031	11,487	21,251	1,763	14,418	1,865	14,418	Call
LEH1343*S6H^A	3	30"	0	2,031	11,487	23,197	1,712	14,418	1,865	14,418	Call
LEH1560*S6HMA	3	30"	0	2,658	12,535	25,209	1,712	18,644	1,865	18,644	Call
LEH1563*S6H^A	3	30"	0	2,506	13,310	24,474	1,712	18,644	1,865	18,644	Call
LEH1820*S6HMA	3	30"	0	2,658	15,653	29,699	1,763	NA	1,933	NA	Call
LEH1823*S6H^A	3	30"	0	2,506	16,336	28,833	1,712	NA	1,933	NA	Call
LEH2330*S6HMA	4	30"	0	2,658	19,890	37,353	2,538	NA	2,163	NA	Call
LEH2333*S6H^A	4	30"	0	2,506	20,452	36,267	5,938	NA	2,163	NA	Call
LEH0983*S4H^A	3	30"	0	2,031	11,487	NA	1,712	14,418	1,865	14,418	Call
LEH1163*S4H^A	3	30"	0	2,031	11,487	NA	1,712	14,418	1,865	14,418	Call
LEH1343*S4H^A	3	30"	0	2,506	13,310	NA	1,712	18,644	1,865	18,644	Call
LEH1583*S4H^A	3	30"	0	2,506	16,336	NA	1,712	NA	1,933	NA	Call
LEH2053*S4H^A	4	30"	0	2,506	20,452	NA	5,938	NA	2,163	NA	Call

- Note**
- Call for Adj. Defrost Term./Fan Delay
 - Call for QCF, TXV, & LLSV
 - Hot Gas Loop is not available for legacy 4 FPI (BHF models) E Voltage models
 - † Call for Bohn-Kote
 - * = Voltage (B = 208-230/1/60, C = 208-230/3/60, M = 460/1/60, D = 460/3/60, E = 575/3/60, X = 380-400/3/50)
 - ^ = Motor (M = 2-Speed EC, Y = 3 Phase AC Open Drip Proof Rail Mount, T = 3 Phase AC Totally Enclosed Rail Mount, P = PSC Open Drip Proof Rail Mount, V = Variable Speed EC Rail Mount, H = High CFM Rail Mount)



SHIPPED-LOOSE ACCESSORIES

A wide range of shipped-loose accessories are available to order. Can't find something? Other options and accessories might be available on a custom order basis. Please contact your local Sales Representative or Account Engineer for assistance.

Part No	Description	List Price (\$US)	Notes
Room Thermostat			
2891040	Room Thermostat	490	
28963301	Electronic Room Thermostat	798	
Extended Throw			
89910701	Collar for Air Throw (24" fan)	851	Must be used with wire fan guards. Must order 1 per fan
89904401	Collar for Air Throw (30" fan)	1132	Must be used with wire fan guards. Must order 1 per fan
Defrost Controls			
21340101	Electric Defrost Timer (60 Hz)	576	
5505R	30-Amp Contactor	644	Use as fan or heater contactor
5738N	50-Amp Contactor	699	Use Interlink part 2252340
Check Valves			
5731F	1 5/8" Suction Line Check Valve	1400	
2933034	2 1/8" Suction Line Check Valve	2869	
2933042	2 5/8" Suction Line Check Valve	3302	
Drain Line Heaters			
5508Q	6 ft. Drain Line heater (208-230V, 42 Watts)	247	
5594P	12 ft. Drain Line heater (208-230V, 84 Watts)	331	
5595P	18 ft. Drain Line heater (208-230V, 126 Watts)	435	
5596P	36 ft. Drain Line heater (208-230V, 252 Watts)	492	
5597P	60 ft. Drain Line heater (208-230V, 420 Watts)	885	
Heat Exchangers			
24200009	Heat Exchanger used on 520 - 630 Air Defrost Models, 450 - 550 Electric & Hot Gas Defrost Models (6 FPI), and 400 - 480 Electric & Hot Gas Defrost Models (4.5 FPI)	960	
24200010	Heat Exchanger used on 750 - 850 Air Defrost Model	1477	
24200011	Heat Exchanger used on 930 - 1400 Air Defrost Models, 640 Electric & Hot Gas Defrost Models (6 FPI), and 560 - 650 Electric & Hot Gas Defrost Models (4.5 FPI)	2027	
24200012	Heat Exchanger used on 740 - 1390 Electric & Hot Gas Defrost Models (6 FPI), and 710 - 1220 Electric & Hot Gas Defrost Models (4.5 FPI)	2377	
24200013	Heat Exchanger used on 1610 - 2440 Air Defrost Models	2554	
24200015	Heat Exchanger used on 2500 - 2780 Air Defrost Models, 1650 - 2120 Electric & Hot Gas Defrost Models (6 FPI), and 1440 - 1860 Electric & Hot Gas Defrost Models (4.5 FPI)	3446	



SHIPPED-LOOSE ACCESSORIES

When placing order, please specify refrigerant type, saturated suction temperature (SST), liquid temperature, and room temperature.

Part No	List Price (\$US)	Capacity Rang (BTUH)
Expansion Valves (TXV)		
TXV036	571	24000 BTUH to 36000 BTUH
TXV060	925	36000 BTUH to 60000 BTUH
TXV120	1173	60000 BTUH to 120000 BTUH
TXV360	1478	120000 BTUH to 360000 BTUH
TXV540	2148	360000 BTUH to 540000 BTUH

Part No	List Price	Size	Capacity Range (R-404A)	
Liquid-line Solenoid Valves (LLSV)			Medium Temp Application (BTUH)	Low Temp Application (BTUH)
5766Y	589	1/2	51,000 BTUH to 72,000 BTUH	44,000 BTUH to 62,000 BTUH
5768Y	782	5/8	72,000 BTUH to 144,000 BTUH	62,000 BTUH to 120,000 BTUH
5804E	965	7/8	144,000 BTUH to 216,000 BTUH	120,000 BTUH to 185,000 BTUH
5803E	1208	1-1/8	216,000 BTUH to 380,000 BTUH	185,000 BTUH to 315,000 BTUH
29318011	589	3/8	24,000 BTUH to 44,000 BTUH	21,000 BTUH to 38,000 BTUH
29318012	589	1/2	36,000 BTUH to 51,000 BTUH	31,000 BTUH to 44,000 BTUH
2930117 (120V)	0	1-3/8	380,000 BTUH to 652,000 BTUH	315,000 BTUH to 540,000 BTUH
2930104	1740	1-3/8	380,000 BTUH to 652,000 BTUH	315,000 BTUH to 540,000 BTUH



SHIPPED-LOOSE ACCESSORIES

intelliGen™ Service Parts

Part Number	Description	List Price (US \$)
Field Mount Kit		
59755002	intelliGen Field Mount (iFM) Kit with 25ft sensor lead wires	\$2,600
Power Harness		
22699903	15ft harness for power, fan, defrost heater, solenoid valve	\$500
22699902	25ft harness for power, fan, defrost heater, solenoid valve	\$830
22699901	40ft harness for power, fan, defrost heater, solenoid valve	\$1,230
Temperature Sensors		
89904903	Temperature Sensor Kit - White Leads, 3ft	\$79
59755302	15ft sensor kit (3 temperature sensors, 1 pressure transducer harness)	\$270
59755301	40ft sensor kit (3 temperature sensors, 1 pressure transducer harness)	\$390
Pressure Transducer & Harnesses		
28911202	Pressure Transducer 0 - 300 PSIA	\$367
22515107	Pressure Transducer Harness, 15ft	\$110
22515105	Pressure Transducer Harness, 40ft	\$190
Transformers		
22529601	Transformer 120/24 volt - 40 VA	\$116
22529602	Transformer 240/24 volt - 40 VA	\$117
22529603	Transformer 460/24 - 40 VA	\$143
22529701	Transformer 575/24 - 40 VA	\$197
Electronic Expansion Valve (EXV) & Cables		
29326101	Carel EXV E2V11FWAE0 - 3/8" x 3/8" Conn	\$1,263
29326201	Carel EXV E2V24FWAE0 - 3/8" x 3/8" Conn	\$1,263
29326401	Carel EXV E2V24FSME0 - 5/8" X 5/8" Conn	\$1,263
29326501	Carel EXV E3V45ASTE0 - 7/8" X 1 3/8" Conn	\$2,481
29326601	Carel EXV E3V55ASTE0 - 7/8" X 1 3/8" Conn	\$2,481
22592201	Cable for Carel EXV, 10ft	\$150
22592103	Cable for Carel EXV, 25ft	\$260
22592102	Cable for Carel EXV, 40ft	\$320
Control Boards		
28918001S	iRC Main Control Board Replacement Kit	\$1,288
28918201S	iRCUI User Interface Replacement Kit	\$871
28918301S	iWC Webserver Card Replacement Kit	\$1,141
28918302S	Multi-system Control with Lead-lag (MSC) Card Field Mount Kit	\$1,575
28918401S	iC Integration Card Replacement Kit	\$660
UI to iRC Ribbon Cables		
22602104	For Medium Profile and Large Unit Cooler, 24" Replacement Kit	\$481
EV-COM Cable		
22596801	EV-COM Cable 28" for Large Unit Cooler DUAL iRC Board Replacement Kit	
Door Switch		
28918001S	Door Switch Kit (includes door switch and 2 ft cable)	\$1,288



SHIPPED-LOOSE ACCESSORIES

intelliGen Retrofit Kits for Beacon II and QRC Controls

Part Number	Defrost Type	Voltage/Phase	Models	Color Finish	List Price (US \$)
intelliGen Retrofit Kits for Beacon II and QRC Controls					
89730401	Air Defrost	230-460/1	24" Fan	Plain Aluminum	\$2,500
89730402			30" Fan		\$2,500
89730403		208-230/3	24" Fan		\$2,500
89730404			30" Fan		\$2,500
897304051			30" Fan		\$5,000
89730406	Electric Defrost	230-460/1	24" Fan		\$2,500
89730407			30" Fan		\$2,500
89730408		208-230/3	24" Fan		\$2,500
89730409			30" Fan		\$2,500
89730410			460/3		24" Fan
89730411		30" Fan		\$2,500	
89730412		575/3	24" Fan	\$2,500	
89730413			30" Fan	\$2,500	
897304141			30" Fan	\$5,000	

Note

1. Part number 89730405 and 89730414 have two intelliGen controls for dual circuited Large Unit Coolers. intelliGen Field Mount (iFM) kit could be used for these models. Ask Heatcraft sales representatives for details.



SHIPPED-LOOSE ACCESSORIES

Hot Gas Reverse Cycle Kits

Need help? Please contact your local Sales Representative or Account Engineer for assistance.

Kits for Models with Standard Electric Pan

Larkin Hot Gas Models Used On		Factory-Installed		Shipped-Loose	
LEH*6H	LEH*4H	Option Code	List Price Adder (\$US)	Part Number	List Price (\$US)
0540	0480 - 0565	RCK.EP-1	5,115	89910901	1,494
0805 - 1210	0730 - 1085	RCK.EP-2	5,115	89910902	1,713
1123	983	RCK.EP-3	5,298	89910903	2,134
1340	1340	RCK.EP-4	7,463	89910904	2,369
1560	1560	RCK.EP-5	7,686	89911101	2,639
1820 - 2330	1820 - 2330	RCK.EP-6	7,686	89911301	2,639

Note

- Factory-installed kits include expansion valve and TXV bypass check valve assembly. Specify valve model style, refrigerant, and SST on order.
- Shipped-loose kits include one check valve and piping for TXV bypass around expansion valve. Kit does not include expansion valve.

Kits for Models with Optional Hot Gas Pan

Larkin Hot Gas Models Used On		Factory-Installed		Shipped-Loose	
LEH*6H	LEH*4H	Option Code	List Price Adder (\$US)	Part Number	List Price (\$US)
0540	0480 - 0565	RCK.HGP-1	7,827	89910905	3,703
0805 - 1210	0730 - 1085	RCK.HGP-2	8,785	89910906	4,702
1123	983	RCK.HGP-3	9,472	89910907	5,126
1340	1340	RCK.HGP-4	10,544	89910908	5,766
1560	1560	RCK.HGP-5	13,816	89911102	9,043
1820 - 2330	1820 - 2330	RCK.HGP-6	15,132	89911302	9,957
2333	2333	RCK.HGP-7	15,159	89911303	9,986

Note

- Factory installed kits included expansion valve, TXV Bypass check valve assembly, suction check valve assembly, and drain pan check valve assembly. Kit does not include hot gas pan price. Specify valve model style, refrigerant, and SST on order.
- Shipped-loose kits include one check valve and piping for TXV bypass around expansion valve, one check valve and piping for drain pan assembly and one check valve and piping for suction assembly. Kit does not include Hot gas pan pricing. Kit does not include expansion valve.

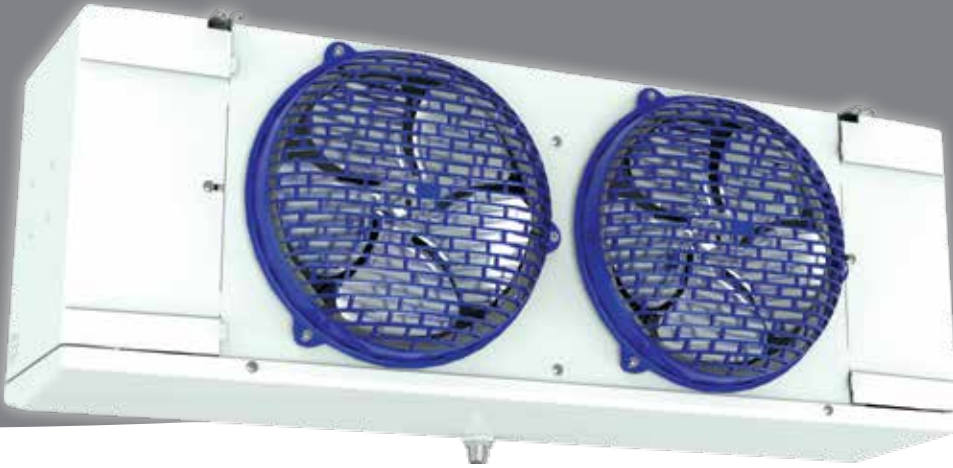

CO₂ DX LOW PROFILE UNIT COOLER

PREFERRED OPTION PACKAGES

Heatcraft now offers pre-defined kits that represent frequently ordered options or combinations of options. The preferred kits make it easier for customers to configure their units and may provide a savings over factory installed a la carte option selections.

Package	Description (standard base model features + indicated options below)
B0500 Standard Base	Danfoss EEV (120V) with 1/4" MPT Transducer Connection (Pressure Transducer not included)
B0501	Danfoss EEV (120V) with 1/4" MPT Transducer Connection (Pressure Transducer not included) + Filter Drier
B0502	Sporlan EEV (120V) with 1/4" MPT Transducer Connection (Pressure Transducer not included) + Filter Drier
B0503	Danfoss EEV (120V) with Danfoss Pressure Transducer
B0504	Danfoss EEV (120V) with Danfoss Pressure Transducer + Filter Drier
B0505	Danfoss EEV (120V) with CPC Pressure Transducer
B0506	Danfoss EEV (120V) with CPC Pressure Transducer + Filter Drier
B0507	Sporlan EEV (120V) with Microthermo Pressure Transducer + Filter Drier



AIR DEFROST PREFERRED MODELS

Please refer to AWEF table in technical bulletin to confirm DOE compliance.

Air Defrost Preferred Models with 2 Speed EC Motors - 115/1/60

Base Model	List Price (\$US)							
	B0500	B0501	B0502	B0503	B0504	B0505	B0506	B0507
LEL0045AC6AMA	8,273	8,273	8,273	8,273	8,273	8,273	8,273	8,273
LEL0055AC6AMA	8,481	8,481	8,481	8,481	8,481	8,481	8,481	8,481
LEL0060AC6AMA	8,694	8,694	8,694	8,694	8,694	8,694	8,694	8,694
LEL0095AC6AMA	10,236	10,236	10,236	10,236	10,236	10,236	10,236	10,236
LEL0105AC6AMA	10,535	10,535	10,535	10,535	10,535	10,535	10,535	10,535
LEL0115AC6AMA	10,871	10,871	10,871	10,871	10,871	10,871	10,871	10,871
LEL0125AC6AMA	11,226	11,226	11,226	11,226	11,226	11,226	11,226	11,226
LEL0155AC6AMA	12,814	12,814	12,814	12,814	12,814	12,814	12,814	12,814
LEL0190AC6AMA	13,725	13,725	13,725	13,725	13,725	13,725	13,725	13,725
LEL0250AC6AMA	15,112	15,112	15,112	15,112	15,112	15,112	15,112	15,112
LEL0295AC6AMA	17,541	17,541	17,541	17,541	17,541	17,541	17,541	17,541
LEL0350AC6AMA	19,409	19,409	19,409	19,409	19,409	19,409	19,409	19,409
LEL0380AC6AMA	21,212	21,212	21,212	21,212	21,212	21,212	21,212	21,212

Air Defrost Preferred Models with 2 Speed EC Motors - 208-230/1/60

Base Model	List Price (\$US)							
	B0500	B0501	B0502	B0503	B0504	B0505	B0506	B0507
LEL0045BC6AMA	8,311	8,311	8,311	8,311	8,311	8,311	8,311	8,311
LEL0055BC6AMA	8,613	8,613	8,613	8,613	8,613	8,613	8,613	8,613
LEL0060BC6AMA	8,916	8,916	8,916	8,916	8,916	8,916	8,916	8,916
LEL0095BC6AMA	10,297	10,297	10,297	10,297	10,297	10,297	10,297	10,297
LEL0105BC6AMA	10,602	10,602	10,602	10,602	10,602	10,602	10,602	10,602
LEL0115BC6AMA	10,936	10,936	10,936	10,936	10,936	10,936	10,936	10,936
LEL0125BC6AMA	11,292	11,292	11,292	11,292	11,292	11,292	11,292	11,292
LEL0155BC6AMA	12,908	12,908	12,908	12,908	12,908	12,908	12,908	12,908
LEL0190BC6AMA	13,811	13,811	13,811	13,811	13,811	13,811	13,811	13,811
LEL0250BC6AMA	15,710	15,710	15,710	15,710	15,710	15,710	15,710	15,710
LEL0295BC6AMA	18,288	18,288	18,288	18,288	18,288	18,288	18,288	18,288
LEL0350BC6AMA	20,257	20,257	20,257	20,257	20,257	20,257	20,257	20,257
LEL0380BC6AMA	21,992	21,992	21,992	21,992	21,992	21,992	21,992	21,992



AIR DEFROST PREFERRED MODELS

Please refer to AWEF table in technical bulletin to confirm DOE compliance.

Air Defrost Preferred Models with EC Motors - 115/1/60

Base Model	List Price (\$US)							
	B0500	B0501	B0502	B0503	B0504	B0505	B0506	B0507
LEL0045AC6AEA	8,185	8,185	8,185	8,185	8,185	8,185	8,185	8,185
LEL0055AC6AEA	8,391	8,391	8,391	8,391	8,391	8,391	8,391	8,391
LEL0060AC6AEA	8,595	8,595	8,595	8,595	8,595	8,595	8,595	8,595
LEL0095AC6AEA	10,095	10,095	10,095	10,095	10,095	10,095	10,095	10,095
LEL0105AC6AEA	10,387	10,387	10,387	10,387	10,387	10,387	10,387	10,387
LEL0115AC6AEA	10,712	10,712	10,712	10,712	10,712	10,712	10,712	10,712
LEL0125AC6AEA	11,056	11,056	11,056	11,056	11,056	11,056	11,056	11,056
LEL0155AC6AEA	12,673	12,673	12,673	12,673	12,673	12,673	12,673	12,673
LEL0190AC6AEA	13,564	13,564	13,564	13,564	13,564	13,564	13,564	13,564
LEL0250AC6AEA	14,926	14,926	14,926	14,926	14,926	14,926	14,926	14,926
LEL0295AC6AEA	17,311	17,311	17,311	17,311	17,311	17,311	17,311	17,311
LEL0350AC6AEA	19,148	19,148	19,148	19,148	19,148	19,148	19,148	19,148
LEL0380AC6AEA	20,915	20,915	20,915	20,915	20,915	20,915	20,915	20,915

Air Defrost Preferred Models with EC Motors - 208-230/1/60

Base Model	List Price (\$US)							
	B0500	B0501	B0502	B0503	B0504	B0505	B0506	B0507
LEL0045BC6AEA	8,224	8,224	8,224	8,224	8,224	8,224	8,224	8,224
LEL0055BC6AEA	8,517	8,517	8,517	8,517	8,517	8,517	8,517	8,517
LEL0060BC6AEA	8,812	8,812	8,812	8,812	8,812	8,812	8,812	8,812
LEL0095BC6AEA	10,154	10,154	10,154	10,154	10,154	10,154	10,154	10,154
LEL0105BC6AEA	10,449	10,449	10,449	10,449	10,449	10,449	10,449	10,449
LEL0115BC6AEA	10,774	10,774	10,774	10,774	10,774	10,774	10,774	10,774
LEL0125BC6AEA	11,122	11,122	11,122	11,122	11,122	11,122	11,122	11,122
LEL0155BC6AEA	12,767	12,767	12,767	12,767	12,767	12,767	12,767	12,767
LEL0190BC6AEA	13,654	13,654	13,654	13,654	13,654	13,654	13,654	13,654
LEL0250BC6AEA	15,514	15,514	15,514	15,514	15,514	15,514	15,514	15,514
LEL0295BC6AEA	18,045	18,045	18,045	18,045	18,045	18,045	18,045	18,045
LEL0350BC6AEA	19,977	19,977	19,977	19,977	19,977	19,977	19,977	19,977
LEL0380BC6AEA	21,683	21,683	21,683	21,683	21,683	21,683	21,683	21,683



AIR DEFROST PREFERRED MODELS

Please refer to AWEF table in technical bulletin to confirm DOE compliance.

Air Defrost Preferred Models with PSC Motors - 115/1/60

Base Model	List Price (\$US)							
	B0500	B0501	B0502	B0503	B0504	B0505	B0506	B0507
LEL0045AC6ACA	7,592	7,592	7,592	7,592	7,592	7,592	7,592	7,592
LEL0055AC6ACA	7,798	7,798	7,798	7,798	7,798	7,798	7,798	7,798
LEL0060AC6ACA	8,003	8,003	8,003	8,003	8,003	8,003	8,003	8,003
LEL0095AC6ACA	8,910	8,910	8,910	8,910	8,910	8,910	8,910	8,910
LEL0105AC6ACA	9,203	9,203	9,203	9,203	9,203	9,203	9,203	9,203
LEL0115AC6ACA	9,526	9,526	9,526	9,526	9,526	9,526	9,526	9,526
LEL0125AC6ACA	9,872	9,872	9,872	9,872	9,872	9,872	9,872	9,872
LEL0155AC6ACA	10,898	10,898	10,898	10,898	10,898	10,898	10,898	10,898
LEL0190AC6ACA	11,789	11,789	11,789	11,789	11,789	11,789	11,789	11,789
LEL0250AC6ACA	12,560	12,560	12,560	12,560	12,560	12,560	12,560	12,560
LEL0295AC6ACA	14,352	14,352	14,352	14,352	14,352	14,352	14,352	14,352
LEL0350AC6ACA	15,593	15,593	15,593	15,593	15,593	15,593	15,593	15,593
LEL0380AC6ACA	17,364	17,364	17,364	17,364	17,364	17,364	17,364	17,364

Air Defrost Preferred Models with PSC Motors - 208-230/1/60

Base Model	List Price (\$US)							
	B0500	B0501	B0502	B0503	B0504	B0505	B0506	B0507
LEL0045BC6ACA	7,633	7,633	7,633	7,633	7,633	7,633	7,633	7,633
LEL0055BC6ACA	7,926	7,926	7,926	7,926	7,926	7,926	7,926	7,926
LEL0060BC6ACA	8,219	8,219	8,219	8,219	8,219	8,219	8,219	8,219
LEL0095BC6ACA	8,972	8,972	8,972	8,972	8,972	8,972	8,972	8,972
LEL0105BC6ACA	9,267	9,267	9,267	9,267	9,267	9,267	9,267	9,267
LEL0115BC6ACA	9,590	9,590	9,590	9,590	9,590	9,590	9,590	9,590
LEL0125BC6ACA	9,936	9,936	9,936	9,936	9,936	9,936	9,936	9,936
LEL0155BC6ACA	10,990	10,990	10,990	10,990	10,990	10,990	10,990	10,990
LEL0190BC6ACA	11,877	11,877	11,877	11,877	11,877	11,877	11,877	11,877
LEL0250BC6ACA	13,147	13,147	13,147	13,147	13,147	13,147	13,147	13,147
LEL0295BC6ACA	15,082	15,082	15,082	15,082	15,082	15,082	15,082	15,082
LEL0350BC6ACA	16,425	16,425	16,425	16,425	16,425	16,425	16,425	16,425
LEL0380BC6ACA	18,130	18,130	18,130	18,130	18,130	18,130	18,130	18,130



AIR DEFROST PREFERRED MODELS

Please refer to AWEF table in technical bulletin to confirm DOE compliance.

Air Defrost Preferred Models with PSC Motors - 460/1/60

Base Model	List Price (\$US)							
	B0500	B0501	B0502	B0503	B0504	B0505	B0506	B0507
LEL0045MC6ACA	7,923	7,923	7,923	7,923	7,923	7,923	7,923	7,923
LEL0055MC6ACA	8,217	8,217	8,217	8,217	8,217	8,217	8,217	8,217
LEL0060MC6ACA	8,511	8,511	8,511	8,511	8,511	8,511	8,511	8,511
LEL0095MC6ACA	9,562	9,562	9,562	9,562	9,562	9,562	9,562	9,562
LEL0105MC6ACA	9,852	9,852	9,852	9,852	9,852	9,852	9,852	9,852
LEL0115MC6ACA	10,173	10,173	10,173	10,173	10,173	10,173	10,173	10,173
LEL0125MC6ACA	10,529	10,529	10,529	10,529	10,529	10,529	10,529	10,529
LEL0155MC6ACA	11,871	11,871	11,871	11,871	11,871	11,871	11,871	11,871
LEL0190MC6ACA	12,756	12,756	12,756	12,756	12,756	12,756	12,756	12,756
LEL0250MC6ACA	14,320	14,320	14,320	14,320	14,320	14,320	14,320	14,320
LEL0295MC6ACA	16,547	16,547	16,547	16,547	16,547	16,547	16,547	16,547
LEL0350MC6ACA	18,186	18,186	18,186	18,186	18,186	18,186	18,186	18,186
LEL0380MC6ACA	19,894	19,894	19,894	19,894	19,894	19,894	19,894	19,894



ELECTRIC DEFROST PREFERRED MODELS

Please refer to AWEF table in technical bulletin to confirm DOE compliance.

Electric Defrost Preferred Models with 2 Speed EC Motors - 208-230/1/60

Base Model	List Price (\$US)							
	B0500	B0501	B0502	B0503	B0504	B0505	B0506	B0507
LELO040BC6EMA	9,593	9,593	9,593	9,593	9,593	9,593	9,593	9,593
LELO045BC6EMA	10,072	10,072	10,072	10,072	10,072	10,072	10,072	10,072
LELO065BC6EMA	10,789	10,789	10,789	10,789	10,789	10,789	10,789	10,789
LELO080BC6EMA	11,506	11,506	11,506	11,506	11,506	11,506	11,506	11,506
LELO100BC6EMA	12,162	12,162	12,162	12,162	12,162	12,162	12,162	12,162
LELO130BC6EMA	14,127	14,127	14,127	14,127	14,127	14,127	14,127	14,127
LELO155BC6EMA	15,326	15,326	15,326	15,326	15,326	15,326	15,326	15,326
LELO170BC6EMA	17,102	17,102	17,102	17,102	17,102	17,102	17,102	17,102
LELO205BC6EMA	18,355	18,355	18,355	18,355	18,355	18,355	18,355	18,355
LELO240BC6EMA	20,312	20,312	20,312	20,312	20,312	20,312	20,312	20,312
LELO255BC6EMA	22,465	22,465	22,465	22,465	22,465	22,465	22,465	22,465
LELO310BC6EMA	24,562	24,562	24,562	24,562	24,562	24,562	24,562	24,562
LELO045BC4EMA	9,245	9,245	9,245	9,245	9,245	9,245	9,245	9,245
LELO070BC4EMA	12,020	12,020	12,020	12,020	12,020	12,020	12,020	12,020
LELO090BC4EMA	12,522	12,522	12,522	12,522	12,522	12,522	12,522	12,522
LELO135BC4EMA	14,051	14,051	14,051	14,051	14,051	14,051	14,051	14,051
LELO180BC4EMA	16,912	16,912	16,912	16,912	16,912	16,912	16,912	16,912
LELO220BC4EMA	20,001	20,001	20,001	20,001	20,001	20,001	20,001	20,001
LELO275BC4EMA	24,235	24,235	24,235	24,235	24,235	24,235	24,235	24,235



ELECTRIC DEFROST PREFERRED MODELS

Please refer to AWEF table in technical bulletin to confirm DOE compliance.

Electric Defrost Preferred Models with 2-Speed EC Motors - 208-230/3/60

Base Model	List Price (\$US)							
	B0500	B0501	B0502	B0503	B0504	B0505	B0506	B0507
LEL0040CC6EMA	9,719	9,719	9,719	9,719	9,719	9,719	9,719	9,719
LEL0045CC6EMA	10,347	10,347	10,347	10,347	10,347	10,347	10,347	10,347
LEL0065CC6EMA	11,164	11,164	11,164	11,164	11,164	11,164	11,164	11,164
LEL0080CC6EMA	11,979	11,979	11,979	11,979	11,979	11,979	11,979	11,979
LEL0100CC6EMA	12,638	12,638	12,638	12,638	12,638	12,638	12,638	12,638
LEL0130CC6EMA	14,597	14,597	14,597	14,597	14,597	14,597	14,597	14,597
LEL0155CC6EMA	15,834	15,834	15,834	15,834	15,834	15,834	15,834	15,834
LEL0170CC6EMA	17,567	17,567	17,567	17,567	17,567	17,567	17,567	17,567
LEL0205CC6EMA	18,967	18,967	18,967	18,967	18,967	18,967	18,967	18,967
LEL0240CC6EMA	20,782	20,782	20,782	20,782	20,782	20,782	20,782	20,782
LEL0255CC6EMA	22,935	22,935	22,935	22,935	22,935	22,935	22,935	22,935
LEL0310CC6EMA	25,282	25,282	25,282	25,282	25,282	25,282	25,282	25,282
LEL0045CC4EMA	9,452	9,452	9,452	9,452	9,452	9,452	9,452	9,452
LEL0070CC4EMA	12,301	12,301	12,301	12,301	12,301	12,301	12,301	12,301
LEL0090CC4EMA	12,727	12,727	12,727	12,727	12,727	12,727	12,727	12,727
LEL0135CC4EMA	14,518	14,518	14,518	14,518	14,518	14,518	14,518	14,518
LEL0180CC4EMA	17,390	17,390	17,390	17,390	17,390	17,390	17,390	17,390
LEL0220CC4EMA	20,470	20,470	20,470	20,470	20,470	20,470	20,470	20,470
LEL0275CC4EMA	24,831	24,831	24,831	24,831	24,831	24,831	24,831	24,831



ELECTRIC DEFROST PREFERRED MODELS

Please refer to AWEF table in technical bulletin to confirm DOE compliance.

Electric Defrost Preferred Models with EC Motors - 208-230/1/60

Base Model	List Price (\$US)							
	B0500	B0501	B0502	B0503	B0504	B0505	B0506	B0507
LEL0040BC6EEA	9,468	9,468	9,468	9,468	9,468	9,468	9,468	9,468
LEL0045BC6EEA	9,934	9,934	9,934	9,934	9,934	9,934	9,934	9,934
LEL0065BC6EEA	10,632	10,632	10,632	10,632	10,632	10,632	10,632	10,632
LEL0080BC6EEA	11,331	11,331	11,331	11,331	11,331	11,331	11,331	11,331
LEL0100BC6EEA	11,967	11,967	11,967	11,967	11,967	11,967	11,967	11,967
LEL0130BC6EEA	13,962	13,962	13,962	13,962	13,962	13,962	13,962	13,962
LEL0155BC6EEA	15,141	15,141	15,141	15,141	15,141	15,141	15,141	15,141
LEL0170BC6EEA	16,881	16,881	16,881	16,881	16,881	16,881	16,881	16,881
LEL0205BC6EEA	18,111	18,111	18,111	18,111	18,111	18,111	18,111	18,111
LEL0240BC6EEA	20,031	20,031	20,031	20,031	20,031	20,031	20,031	20,031
LEL0255BC6EEA	22,143	22,143	22,143	22,143	22,143	22,143	22,143	22,143
LEL0310BC6EEA	24,205	24,205	24,205	24,205	24,205	24,205	24,205	24,205
LEL0045BC4EEA	9,131	9,131	9,131	9,131	9,131	9,131	9,131	9,131
LEL0070BC4EEA	11,832	11,832	11,832	11,832	11,832	11,832	11,832	11,832
LEL0090BC4EEA	12,316	12,316	12,316	12,316	12,316	12,316	12,316	12,316
LEL0135BC4EEA	13,884	13,884	13,884	13,884	13,884	13,884	13,884	13,884
LEL0180BC4EEA	16,692	16,692	16,692	16,692	16,692	16,692	16,692	16,692
LEL0220BC4EEA	19,726	19,726	19,726	19,726	19,726	19,726	19,726	19,726
LEL0275BC4EEA	23,881	23,881	23,881	23,881	23,881	23,881	23,881	23,881



ELECTRIC DEFROST PREFERRED MODELS

Please refer to AWEF table in technical bulletin to confirm DOE compliance.

Electric Defrost Preferred Models with EC Motors - 208-230/3/60

Base Model	List Price (\$US)							
	B0500	B0501	B0502	B0503	B0504	B0505	B0506	B0507
LEL0040CC6EEA	9,592	9,592	9,592	9,592	9,592	9,592	9,592	9,592
LEL0045CC6EEA	10,205	10,205	10,205	10,205	10,205	10,205	10,205	10,205
LEL0065CC6EEA	10,994	10,994	10,994	10,994	10,994	10,994	10,994	10,994
LEL0080CC6EEA	11,789	11,789	11,789	11,789	11,789	11,789	11,789	11,789
LEL0100CC6EEA	12,431	12,431	12,431	12,431	12,431	12,431	12,431	12,431
LEL0130CC6EEA	14,421	14,421	14,421	14,421	14,421	14,421	14,421	14,421
LEL0155CC6EEA	15,637	15,637	15,637	15,637	15,637	15,637	15,637	15,637
LEL0170CC6EEA	17,337	17,337	17,337	17,337	17,337	17,337	17,337	17,337
LEL0205CC6EEA	18,712	18,712	18,712	18,712	18,712	18,712	18,712	18,712
LEL0240CC6EEA	20,495	20,495	20,495	20,495	20,495	20,495	20,495	20,495
LEL0255CC6EEA	22,605	22,605	22,605	22,605	22,605	22,605	22,605	22,605
LEL0310CC6EEA	24,912	24,912	24,912	24,912	24,912	24,912	24,912	24,912
LEL0045CC4EEA	9,331	9,331	9,331	9,331	9,331	9,331	9,331	9,331
LEL0070CC4EEA	12,100	12,100	12,100	12,100	12,100	12,100	12,100	12,100
LEL0090CC4EEA	12,515	12,515	12,515	12,515	12,515	12,515	12,515	12,515
LEL0135CC4EEA	14,346	14,346	14,346	14,346	14,346	14,346	14,346	14,346
LEL0180CC4EEA	17,164	17,164	17,164	17,164	17,164	17,164	17,164	17,164
LEL0220CC4EEA	20,188	20,188	20,188	20,188	20,188	20,188	20,188	20,188
LEL0275CC4EEA	24,466	24,466	24,466	24,466	24,466	24,466	24,466	24,466



ELECTRIC DEFROST PREFERRED MODELS

Please refer to AWEF table in technical bulletin to confirm DOE compliance.

Electric Defrost Preferred Models with PSC Motors - 208-230/1/60

Base Model	List Price (\$US)							
	B0500	B0501	B0502	B0503	B0504	B0505	B0506	B0507
LEL0040BC6ECA	8,876	8,876	8,876	8,876	8,876	8,876	8,876	8,876
LEL0045BC6ECA	9,343	9,343	9,343	9,343	9,343	9,343	9,343	9,343
LEL0065BC6ECA	9,744	9,744	9,744	9,744	9,744	9,744	9,744	9,744
LEL0080BC6ECA	10,146	10,146	10,146	10,146	10,146	10,146	10,146	10,146
LEL0100BC6ECA	10,783	10,783	10,783	10,783	10,783	10,783	10,783	10,783
LEL0130BC6ECA	12,187	12,187	12,187	12,187	12,187	12,187	12,187	12,187
LEL0155BC6ECA	13,364	13,364	13,364	13,364	13,364	13,364	13,364	13,364
LEL0170BC6ECA	14,513	14,513	14,513	14,513	14,513	14,513	14,513	14,513
LEL0205BC6ECA	15,743	15,743	15,743	15,743	15,743	15,743	15,743	15,743
LEL0240BC6ECA	17,072	17,072	17,072	17,072	17,072	17,072	17,072	17,072
LEL0255BC6ECA	18,590	18,590	18,590	18,590	18,590	18,590	18,590	18,590
LEL0310BC6ECA	20,655	20,655	20,655	20,655	20,655	20,655	20,655	20,655
LEL0045BC4ECA	8,538	8,538	8,538	8,538	8,538	8,538	8,538	8,538
LEL0070BC4ECA	10,645	10,645	10,645	10,645	10,645	10,645	10,645	10,645
LEL0090BC4ECA	11,131	11,131	11,131	11,131	11,131	11,131	11,131	11,131
LEL0135BC4ECA	12,111	12,111	12,111	12,111	12,111	12,111	12,111	12,111
LEL0180BC4ECA	14,324	14,324	14,324	14,324	14,324	14,324	14,324	14,324
LEL0220BC4ECA	16,766	16,766	16,766	16,766	16,766	16,766	16,766	16,766
LEL0275BC4ECA	20,328	20,328	20,328	20,328	20,328	20,328	20,328	20,328



ELECTRIC DEFROST PREFERRED MODELS

Please refer to AWEF table in technical bulletin to confirm DOE compliance.

Electric Defrost Preferred Models with PSC Motors - 208-230/3/60

Base Model	List Price (\$US)							
	B0500	B0501	B0502	B0503	B0504	B0505	B0506	B0507
LEL0040CC6ECA	9,001	9,001	9,001	9,001	9,001	9,001	9,001	9,001
LEL0045CC6ECA	9,614	9,614	9,614	9,614	9,614	9,614	9,614	9,614
LEL0065CC6ECA	10,108	10,108	10,108	10,108	10,108	10,108	10,108	10,108
LEL0080CC6ECA	10,605	10,605	10,605	10,605	10,605	10,605	10,605	10,605
LEL0100CC6ECA	11,248	11,248	11,248	11,248	11,248	11,248	11,248	11,248
LEL0130CC6ECA	12,647	12,647	12,647	12,647	12,647	12,647	12,647	12,647
LEL0155CC6ECA	13,859	13,859	13,859	13,859	13,859	13,859	13,859	13,859
LEL0170CC6ECA	14,971	14,971	14,971	14,971	14,971	14,971	14,971	14,971
LEL0205CC6ECA	16,344	16,344	16,344	16,344	16,344	16,344	16,344	16,344
LEL0240CC6ECA	17,534	17,534	17,534	17,534	17,534	17,534	17,534	17,534
LEL0255CC6ECA	19,053	19,053	19,053	19,053	19,053	19,053	19,053	19,053
LEL0310CC6ECA	21,358	21,358	21,358	21,358	21,358	21,358	21,358	21,358
LEL0045CC4ECA	8,742	8,742	8,742	8,742	8,742	8,742	8,742	8,742
LEL0070CC4ECA	10,916	10,916	10,916	10,916	10,916	10,916	10,916	10,916
LEL0090CC4ECA	11,333	11,333	11,333	11,333	11,333	11,333	11,333	11,333
LEL0135CC4ECA	12,569	12,569	12,569	12,569	12,569	12,569	12,569	12,569
LEL0180CC4ECA	14,799	14,799	14,799	14,799	14,799	14,799	14,799	14,799
LEL0220CC4ECA	17,228	17,228	17,228	17,228	17,228	17,228	17,228	17,228
LEL0275CC4ECA	20,914	20,914	20,914	20,914	20,914	20,914	20,914	20,914



ELECTRIC DEFROST PREFERRED MODELS

Please refer to AWEF table in technical bulletin to confirm DOE compliance.

Electric Defrost Preferred Models with PSC Motors - 460/1/60

Base Model	List Price (\$US)							
	B0500	B0501	B0502	B0503	B0504	B0505	B0506	B0507
LEL0040MC6ECA	9,296	9,296	9,296	9,296	9,296	9,296	9,296	9,296
LEL0045MC6ECA	9,910	9,910	9,910	9,910	9,910	9,910	9,910	9,910
LEL0065MC6ECA	10,550	10,550	10,550	10,550	10,550	10,550	10,550	10,550
LEL0080MC6ECA	11,192	11,192	11,192	11,192	11,192	11,192	11,192	11,192
LEL0100MC6ECA	11,836	11,836	11,836	11,836	11,836	11,836	11,836	11,836
LEL0130MC6ECA	13,526	13,526	13,526	13,526	13,526	13,526	13,526	13,526
LEL0155MC6ECA	14,747	14,747	14,747	14,747	14,747	14,747	14,747	14,747
LEL0170MC6ECA	16,148	16,148	16,148	16,148	16,148	16,148	16,148	16,148
LEL0205MC6ECA	17,515	17,515	17,515	17,515	17,515	17,515	17,515	17,515
LEL0240MC6ECA	18,999	18,999	18,999	18,999	18,999	18,999	18,999	18,999
LEL0255MC6ECA	20,818	20,818	20,818	20,818	20,818	20,818	20,818	20,818
LEL0310MC6ECA	23,116	23,116	23,116	23,116	23,116	23,116	23,116	23,116
LEL0045MC4ECA	9,031	9,031	9,031	9,031	9,031	9,031	9,031	9,031
LEL0070MC4ECA	11,208	11,208	11,208	11,208	11,208	11,208	11,208	11,208
LEL0090MC4ECA	11,626	11,626	11,626	11,626	11,626	11,626	11,626	11,626
LEL0135MC4ECA	13,454	13,454	13,454	13,454	13,454	13,454	13,454	13,454
LEL0180MC4ECA	15,966	15,966	15,966	15,966	15,966	15,966	15,966	15,966
LEL0220MC4ECA	18,698	18,698	18,698	18,698	18,698	18,698	18,698	18,698
LEL0275MC4ECA	22,675	22,675	22,675	22,675	22,675	22,675	22,675	22,675

CO₂ DX LOW PROFILE UNIT COOLER



SHIPPED-LOOSE ACCESSORIES

Part Number	Description	List Price (US \$)
Electronic Expansion Valves (EEV)		
29330610	Valve Expansion Akv 10P0 W/O Coil	2,809
29330601	Valve Expansion Akv 10P1 W/O Coil	2,809
29330602	Valve Expansion Akv 10P2 W/O Coil	2,809
29330603	Valve Expansion Akv 10P3 W/O Coil	2,809
29330604	Valve Expansion Akv 10P4 W/O Coil	2,809
29330605	Valve Expansion Akv 10P5 W/O Coil	2,809
29330606	Valve Expansion Akv 10P6 W/O Coil	2,809
29330607	Valve Expansion Akv 10P7 W/O Coil	2,809
29326004	Valve Expansion Akv 10Ps4 W/O Coil	3,137
29326005	Valve Expansion Akv 10Ps5 W/O Coil	3,137
29326006	Valve Expansion Akv 10Ps6 W/O Coil	3,254
29326007	Valve Expansion Akv 10Ps7 W/O Coil	3,254
29390201	Valve Expansion Ser-Aa	2,429
29390101	Valve Expansion Ser-A	2,890
29389401	Valve Expansion Ser-B Cable With Strippe	1,992
29389501	Valve Expansion Ser-C With Cable With St	1,992
29389601	Valve Expansion Ser-C 4X5 Odf-10'-S, 805	1,992
29389701	Valve Expansion Ser-D 4X5 Odf-10'-S, 805	1,992
29389801	Valve Expansion Ser-D 4X7Odf-10'-S, 8052	1,992
EEV Coils		
29321201	Valve Expansion Elec Coil 208/240Vac	560
29378101	Valve Expansion Elec Xv Coil 120V 16W	558
29321303	Valve Expansion Elec Xv Coil 24Vac	960
Pressure Transducer		
28977108	Pressure Tansducer	4,006
28977045	CPC Transducer	4,867
28912701	Slo- Trans Press Microthermo 952-0008	2,266
Transducer Cable		
28912401	Cable Pressure Transducer 5M	707
Filter Drier		
22103201	Filter Drier DMT 083S, R-744 CO2	644
22103301	Filter Drier DMT 084S, R744 CO2	836
2210059	Filter Drier C-084-S 1/2SOLDER	176
4600C	Filter Drier 3/8" ODF EK-033S (22101711)	220



SHIPPED-LOOSE ACCESSORIES

Part Number	Description	List Price (US \$)
Sensors		
22524602	Temp Sensor Cpc BI5011125, Blue - Ent Air	162
22524605	Sensor Temp Cpc Red - Suc Temp	219
22524606	Temp Sensor Cpc Green (20 Ft) - Leave Air	872
22524607	Temp Sensor Orange - Def Term	162
22527201	Sensor Temperature Sensor Danfoss Ak11	446
28923072	Sensor Microthermo Probe #23-0072 - Def Term	608
28923073	Microthermo Probe #23-0073 - Ent Air	567
28923074	Sensor Microthermo Temp 23-0076 - Suc Temp	378
Defrost Control		
4267W	Adjustable Defrost Control/Fan Delay Switch	483
Drain Line Heaters		
5508Q	6 ft. Drain Line Heater (208-230V, 42 Watts)	247
5594P	12 ft. Drain Line Heater (208-230V, 84 Watts)	331
5595P	18 ft. Drain Line Heater (208-230V, 126 Watts)	435
5596P	36 ft. Drain Line Heater (208-230V, 252 Watts)	492
5597P	60 ft. Drain Line Heater (208-230V, 420 Watts)	885

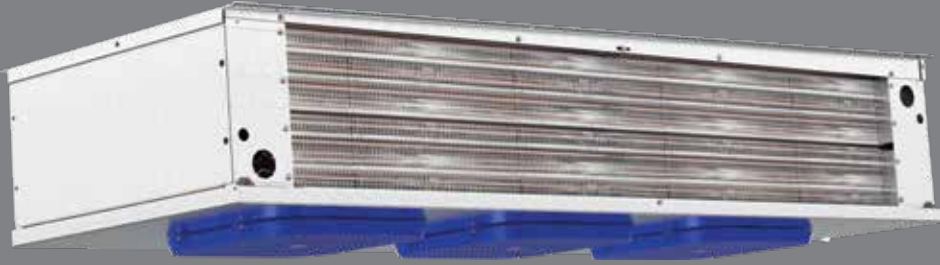

CO₂ DX LOW VELOCITY CENTER MOUNT UNIT COOLER

PREFERRED OPTION PACKAGES

Heatcraft now offers pre-defined kits that represent frequently ordered options or combinations of options. The preferred kits make it easier for customers to configure their units and may provide a savings over factory installed a la carte option selections.

Package	Description (standard base model features + indicated options below)
B0500 Standard Base	Danfoss EEV (120V) with 1/4" MPT Transducer Connection (Pressure Transducer not included)
B0501	Danfoss EEV (120V) with 1/4" MPT Transducer Connection (Pressure Transducer not included) + Filter Drier
B0502	Sporlan EEV (120V) with 1/4" MPT Transducer Connection (Pressure Transducer not included) + Filter Drier
B0503	Danfoss EEV (120V) with Danfoss Pressure Transducer
B0504	Danfoss EEV (120V) with Danfoss Pressure Transducer + Filter Drier
B0505	Danfoss EEV (120V) with CPC Pressure Transducer
B0506	Danfoss EEV (120V) with CPC Pressure Transducer + Filter Drier
B0507	Sporlan EEV (120V) with Microthermo Pressure Transducer + Filter Drier



AIR DEFROST PREFERRED MODELS

Please refer to AWEF table in technical bulletin to confirm DOE compliance.

Air Defrost Models with 2 Speed EC Motors - 115/1/60

Base Model	List Price (\$US)							
	B0500	B0501	B0502	B0503	B0504	B0505	B0506	B0507
LEV0055AC6AMA	14,717	14,717	14,717	14,717	14,717	14,717	14,717	14,717
LEV0080AC6AMA	15,754	15,754	15,754	15,754	15,754	15,754	15,754	15,754
LEV0125AC6AMA	17,469	17,469	17,469	17,469	17,469	17,469	17,469	17,469
LEV0160AC6AMA	19,012	19,012	19,012	19,012	19,012	19,012	19,012	19,012
LEV0180AC6AMA	20,284	20,284	20,284	20,284	20,284	20,284	20,284	20,284
LEV0215AC6AMA	23,008	23,008	23,008	23,008	23,008	23,008	23,008	23,008
LEV0245AC6AMA	24,986	24,986	24,986	24,986	24,986	24,986	24,986	24,986
LEV0290AC6AMA	26,588	26,588	26,588	26,588	26,588	26,588	26,588	26,588
LEV0360AC6AMA	31,792	31,792	31,792	31,792	31,792	31,792	31,792	31,792

Air Defrost Models with 2 Speed EC Motors - 208-230/1/60

Base Model	List Price (\$US)							
	B0500	B0501	B0502	B0503	B0504	B0505	B0506	B0507
LEV0055BC6AMA	15,066	15,066	15,066	15,066	15,066	15,066	15,066	15,066
LEV0080BC6AMA	16,166	16,166	16,166	16,166	16,166	16,166	16,166	16,166
LEV0125BC6AMA	17,944	17,944	17,944	17,944	17,944	17,944	17,944	17,944
LEV0160BC6AMA	19,585	19,585	19,585	19,585	19,585	19,585	19,585	19,585
LEV0180BC6AMA	20,932	20,932	20,932	20,932	20,932	20,932	20,932	20,932
LEV0215BC6AMA	23,784	23,784	23,784	23,784	23,784	23,784	23,784	23,784
LEV0245BC6AMA	25,843	25,843	25,843	25,843	25,843	25,843	25,843	25,843
LEV0290BC6AMA	27,531	27,531	27,531	27,531	27,531	27,531	27,531	27,531
LEV0360BC6AMA	33,011	33,011	33,011	33,011	33,011	33,011	33,011	33,011

CO₂ DX - LOW VELOCITY CENTER MOUNT UNIT COOLER



ELECTRIC DEFROST PREFERRED MODELS

Please refer to AWEF table in technical bulletin to confirm DOE compliance.

Electric Defrost Models with 2 Speed EC Motors - 208-230/1/60

Base Model	List Price (\$US)							
	B0500	B0501	B0502	B0503	B0504	B0505	B0506	B0507
LEV0055BC6EMA	15,827	15,827	15,827	15,827	15,827	15,827	15,827	15,827
LEV0080BC6EMA	17,059	17,059	17,059	17,059	17,059	17,059	17,059	17,059
LEV0125BC6EMA	18,988	18,988	18,988	18,988	18,988	18,988	18,988	18,988
LEV0160BC6EMA	20,816	20,816	20,816	20,816	20,816	20,816	20,816	20,816
LEV0180BC6EMA	22,335	22,335	22,335	22,335	22,335	22,335	22,335	22,335
LEV0215BC6EMA	25,447	25,447	25,447	25,447	25,447	25,447	25,447	25,447
LEV0245BC6EMA	27,680	27,680	27,680	27,680	27,680	27,680	27,680	27,680
LEV0290BC6EMA	29,582	29,582	29,582	29,582	29,582	29,582	29,582	29,582
LEV0360BC6EMA	35,658	35,658	35,658	35,658	35,658	35,658	35,658	35,658



CO₂ DX - LOW VELOCITY CENTER MOUNT UNIT COOLER

SHIPPED-LOOSE ACCESSORIES

Part Number	Description	List Price (US \$)
Electronic Expansion Valves (EEV)		
29330610	Valve Expansion Akv 10P0 W/O Coil	2,809
29330601	Valve Expansion Akv 10P1 W/O Coil	2,809
29330602	Valve Expansion Akv 10P2 W/O Coil	2,809
29330603	Valve Expansion Akv 10P3 W/O Coil	2,809
29330604	Valve Expansion Akv 10P4 W/O Coil	2,809
29330605	Valve Expansion Akv 10P5 W/O Coil	2,809
29330606	Valve Expansion Akv 10P6 W/O Coil	2,809
29330607	Valve Expansion Akv 10P7 W/O Coil	2,809
29326004	Valve Expansion Akv 10Ps4 W/O Coil	3,137
29326005	Valve Expansion Akv 10Ps5 W/O Coil	3,137
29326006	Valve Expansion Akv 10Ps6 W/O Coil	3,254
29326007	Valve Expansion Akv 10Ps7 W/O Coil	3,254
29390201	Valve Expansion Ser-Aa	2,429
29390101	Valve Expansion Ser-A	2,890
29389401	Valve Expansion Ser-B Cable With Strippe	1,992
29389501	Valve Expansion Ser-C With Cable With St	1,992
29389601	Valve Expansion Ser-C 4X5 Odf-10'-S, 805	1,992
29389701	Valve Expansion Ser-D 4X5 Odf-10'-S, 805	1,992
29389801	Valve Expansion Ser-D 4X7Odf-10'-S, 8052	1,992
EEV Coils		
29321201	Valve Expansion Elec Coil 208/240Vac	560
29378101	Valve Expansion Elec Xv Coil 120V 16W	558
29321303	Valve Expansion Elec Xv Coil 24Vac	960
Pressure Transducer		
28977108	Pressure Tansducer	4,006
28977045	CPC Transducer	4,867
28912701	Slo- Trans Press Microthermo 952-0008	2,266
Transducer Cable		
28912401	Cable Pressure Transducer 5M	707
Filter Drier		
22103201	Filter Drier DMT 083S, R-744 CO2	644
22103301	Filter Drier DMT 084S, R744 CO2	836
2210059	Filter Drier C-084-S 1/2SOLDER	176
4600C	Filter Drier 3/8" ODF EK-033S (22101711)	220



SHIPPED-LOOSE ACCESSORIES

Part Number	Description	List Price (US \$)
Sensors		
22524602	Temp Sensor Cpc BI5011125, Blue - Ent Air	162
22524605	Sensor Temp Cpc Red - Suc Temp	219
22524606	Temp Sensor Cpc Green (20 Ft) - Leave Air	872
22524607	Temp Sensor Orange - Def Term	162
22527201	Sensor Temperature Sensor Danfoss Ak11	446
28923072	Sensor Microthermo Probe #23-0072 - Def Term	608
28923073	Microthermo Probe #23-0073 - Ent Air	567
28923074	Sensor Microthermo Temp 23-0076 - Suc Temp	378
Defrost Control		
4267W	Adjustable Defrost Control/Fan Delay Switch	483
Drain Line Heaters		
5508Q	6 ft. Drain Line Heater (208-230V, 42 Watts)	247
5594P	12 ft. Drain Line Heater (208-230V, 84 Watts)	331
5595P	18 ft. Drain Line Heater (208-230V, 126 Watts)	435
5596P	36 ft. Drain Line Heater (208-230V, 252 Watts)	492
5597P	60 ft. Drain Line Heater (208-230V, 420 Watts)	885

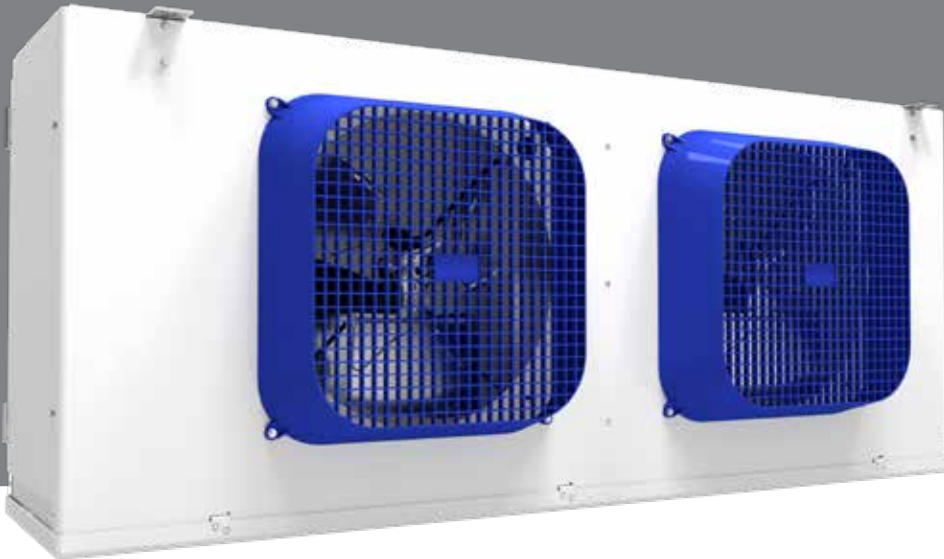

CO₂ DX MEDIUM PROFILE UNIT COOLER

NOMENCLATURE

PRODUCT IDENTIFIER E = Evaporator	NOMINAL CAPACITY x100 = BTU/h	APPLICATION S = Standard Refrigerants C = CO ₂	DEFROST A = Air E = Electric H = Hot Gas	REVISION						
L	E	M	0185	A	C	8	A	M	B	B0000
BRAND L = Larkin	EVAPORATOR STYLE M = Medium Profile	VOLTAGE A = 115/1/60 B = 208-230/1/60 C = 208-230/3/60 M = 460/1/60 D = 460/3/60 E = 575/3/60 L = 575/1/60	FINS PER INCH (fpi) 4 6 8	MOTOR M = 2 Speed EC E = Fixed Speed EC C = PSC Totally Enclosed V = Variable Speed EC P = PSC	FACTORY-INSTALLED OPTION PACKAGES B#### = Preferred Option Packages D#### = A la Carte Options Y#### = Custom Option Packages					



PREFERRED OPTION PACKAGES

Heatcraft now offers pre-defined kits that represent frequently ordered options or combinations of options. The preferred kits make it easier for customers to configure their units and may provide a savings over factory installed a la carte option selections.

Package	Description (standard base model features + indicated options below)
B0500 Standard Base	Danfoss EEV (120V) with 1/4”MPT Transducer Connection (Pressure Transducer not included)
B0501	Danfoss EEV (120V) with 1/4”MPT Transducer Connection (Pressure Transducer not included) + Filter Drier
B0502	Sporlan EEV (120V) with 1/4”MPT Transducer Connection (Pressure Transducer not included) + Filter Drier
B0503	Danfoss EEV (120V) with Danfoss Pressure Transducer
B0504	Danfoss EEV (120V) with Danfoss Pressure Transducer + Filter Drier
B0505	Danfoss EEV (120V) with CPC Pressure Transducer
B0506	Danfoss EEV (120V) with CPC Pressure Transducer + Filter Drier
B0507	Sporlan EEV (120V) with Microthermo Pressure Transducer + Filter Drier



AIR DEFROST PREFERRED MODELS

Please consult AWEF and Net Capacity table of Technical bulletin to confirm DOE compliance per model

Air Defrost Preferred Models with 2 Speed EC Motors - 115/1/60

Base Model	List Price (\$US)							
	B0500	B0501	B0502	B0503	B0504	B0505	B0506	B0507
LEM0185AC8AMA	14,763	14,763	14,763	14,763	14,763	14,763	14,763	14,763
LEM0225AC8AMA	16,040	16,040	16,040	16,040	16,040	16,040	16,040	16,040
LEM0405AC8AMA	20,669	20,669	20,669	20,669	20,669	20,669	20,669	20,669
LEM0475AC8AMA	23,902	23,902	23,902	23,902	23,902	23,902	23,902	23,902
LEM0575AC8AMA	28,543	28,543	28,543	28,543	28,543	28,543	28,543	28,543
LEM0675AC8AMA	32,190	32,190	32,190	32,190	32,190	32,190	32,190	32,190
LEM0775AC8AMA	36,971	36,971	36,971	36,971	36,971	36,971	36,971	36,971
LEM0975AC8AMA	38,555	38,555	38,555	38,555	38,555	38,555	38,555	38,555

Air Defrost Preferred Models with 2 Speed EC Motors - 208-230/1/60

Base Model	List Price (\$US)							
	B0500	B0501	B0502	B0503	B0504	B0505	B0506	B0507
LEM0185BC8AMA	14,890	14,890	14,890	14,890	14,890	14,890	14,890	14,890
LEM0225BC8AMA	16,156	16,156	16,156	16,156	16,156	16,156	16,156	16,156
LEM0405BC8AMA	20,907	20,907	20,907	20,907	20,907	20,907	20,907	20,907
LEM0475BC8AMA	24,143	24,143	24,143	24,143	24,143	24,143	24,143	24,143
LEM0575BC8AMA	28,917	28,917	28,917	28,917	28,917	28,917	28,917	28,917
LEM0675BC8AMA	32,562	32,562	32,562	32,562	32,562	32,562	32,562	32,562
LEM0775BC8AMA	37,451	37,451	37,451	37,451	37,451	37,451	37,451	37,451
LEM0975BC8AMA	39,044	39,044	39,044	39,044	39,044	39,044	39,044	39,044
LEM1115BC8AMA	43,973	43,973	43,973	43,973	43,973	43,973	43,973	43,973

Air Defrost Preferred Models with 2 Speed EC Motors - 460/1/60

Base Model	List Price (\$US)							
	B0500	B0501	B0502	B0503	B0504	B0505	B0506	B0507
LEM0185MC8AMA	17,417	17,417	17,417	17,417	17,417	17,417	17,417	17,417
LEM0225MC8AMA	19,069	19,069	19,069	19,069	19,069	19,069	19,069	19,069
LEM0405MC8AMA	25,266	25,266	25,266	25,266	25,266	25,266	25,266	25,266
LEM0475MC8AMA	29,488	29,488	29,488	29,488	29,488	29,488	29,488	29,488
LEM0575MC8AMA	35,711	35,711	35,711	35,711	35,711	35,711	35,711	35,711
LEM0675MC8AMA	40,466	40,466	40,466	40,466	40,466	40,466	40,466	40,466
LEM0775MC8AMA	46,850	46,850	46,850	46,850	46,850	46,850	46,850	46,850
LEM0975MC8AMA	48,923	48,923	48,923	48,923	48,923	48,923	48,923	48,923
LEM1115MC8AMA	55,352	55,352	55,352	55,352	55,352	55,352	55,352	55,352



AIR DEFROST PREFERRED MODELS

Please consult AWEF and Net Capacity table of Technical bulletin to confirm DOE compliance per model

Air Defrost Preferred Models with EC Motors - 115/1/60

Base Model	List Price (\$US)							
	B0500	B0501	B0502	B0503	B0504	B0505	B0506	B0507
LEM0185AC8AEA	14,336	14,336	14,336	14,336	14,336	14,336	14,336	14,336
LEM0225AC8AEA	15,549	15,549	15,549	15,549	15,549	15,549	15,549	15,549
LEM0405AC8AEA	19,935	19,935	19,935	19,935	19,935	19,935	19,935	19,935
LEM0475AC8AEA	22,999	22,999	22,999	22,999	22,999	22,999	22,999	22,999
LEM0575AC8AEA	27,398	27,398	27,398	27,398	27,398	27,398	27,398	27,398
LEM0675AC8AEA	30,852	30,852	30,852	30,852	30,852	30,852	30,852	30,852
LEM0775AC8AEA	35,385	35,385	35,385	35,385	35,385	35,385	35,385	35,385
LEM0975AC8AEA	36,889	36,889	36,889	36,889	36,889	36,889	36,889	36,889

Air Defrost Preferred Models with EC Motors - 208-230/1/60

Base Model	List Price (\$US)							
	B0500	B0501	B0502	B0503	B0504	B0505	B0506	B0507
LEM0185BC8AEA	14,456	14,456	14,456	14,456	14,456	14,456	14,456	14,456
LEM0225BC8AEA	15,656	15,656	15,656	15,656	15,656	15,656	15,656	15,656
LEM0405BC8AEA	20,159	20,159	20,159	20,159	20,159	20,159	20,159	20,159
LEM0475BC8AEA	23,227	23,227	23,227	23,227	23,227	23,227	23,227	23,227
LEM0575BC8AEA	27,752	27,752	27,752	27,752	27,752	27,752	27,752	27,752
LEM0675BC8AEA	31,204	31,204	31,204	31,204	31,204	31,204	31,204	31,204
LEM0775BC8AEA	35,841	35,841	35,841	35,841	35,841	35,841	35,841	35,841
LEM0975BC8AEA	37,353	37,353	37,353	37,353	37,353	37,353	37,353	37,353
LEM1115BC8AEA	42,021	42,021	42,021	42,021	42,021	42,021	42,021	42,021



AIR DEFROST PREFERRED MODELS

Please consult AWEF and Net Capacity table of Technical bulletin to confirm DOE compliance per model

Air Defrost Preferred Models with PSC Motors Totally Enclosed - 208-230/1/60

Base Model	List Price (\$US)							
	B0500	B0501	B0502	B0503	B0504	B0505	B0506	B0507
LEM0185BC8ACA	13,799	13,799	13,799	13,799	13,799	13,799	13,799	13,799
LEM0225BC8ACA	15,011	15,011	15,011	15,011	15,011	15,011	15,011	15,011
LEM0405BC8ACA	18,826	18,826	18,826	18,826	18,826	18,826	18,826	18,826
LEM0475BC8ACA	21,923	21,923	21,923	21,923	21,923	21,923	21,923	21,923
LEM0575BC8ACA	25,756	25,756	25,756	25,756	25,756	25,756	25,756	25,756
LEM0675BC8ACA	29,244	29,244	29,244	29,244	29,244	29,244	29,244	29,244
LEM0775BC8ACA	33,195	33,195	33,195	33,195	33,195	33,195	33,195	33,195
LEM0975BC8ACA	34,719	34,719	34,719	34,719	34,719	34,719	34,719	34,719
LEM1115BC8ACA	38,701	38,701	38,701	38,701	38,701	38,701	38,701	38,701

Air Defrost Preferred Models with PSC Motors Totally Enclosed - 460/1/60

Base Model	List Price (\$US)							
	B0500	B0501	B0502	B0503	B0504	B0505	B0506	B0507
LEM0185MC8ACA	14,143	14,143	14,143	14,143	14,143	14,143	14,143	14,143
LEM0225MC8ACA	15,360	15,360	15,360	15,360	15,360	15,360	15,360	15,360
LEM0405MC8ACA	19,519	19,519	19,519	19,519	19,519	19,519	19,519	19,519
LEM0475MC8ACA	22,611	22,611	22,611	22,611	22,611	22,611	22,611	22,611
LEM0575MC8ACA	26,779	26,779	26,779	26,779	26,779	26,779	26,779	26,779
LEM0675MC8ACA	30,274	30,274	30,274	30,274	30,274	30,274	30,274	30,274
LEM0775MC8ACA	34,566	34,566	34,566	34,566	34,566	34,566	34,566	34,566
LEM0975MC8ACA	36,089	36,089	36,089	36,089	36,089	36,089	36,089	36,089
LEM1115MC8ACA	40,415	40,415	40,415	40,415	40,415	40,415	40,415	40,415



AIR DEFROST PREFERRED MODELS

Please consult AWEF and Net Capacity table of Technical bulletin to confirm DOE compliance per model

Air Defrost Preferred Models with PSC Motors - 115/1/60

Base Model	List Price (\$US)							
	B0500	B0501	B0502	B0503	B0504	B0505	B0506	B0507
LEM0185AC8APA	13,226	13,226	13,226	13,226	13,226	13,226	13,226	13,226
LEM0225AC8APA	14,450	14,450	14,450	14,450	14,450	14,450	14,450	14,450
LEM0405AC8APA	17,693	17,693	17,693	17,693	17,693	17,693	17,693	17,693
LEM0475AC8APA	20,786	20,786	20,786	20,786	20,786	20,786	20,786	20,786
LEM0575AC8APA	24,043	24,043	24,043	24,043	24,043	24,043	24,043	24,043
LEM0675AC8APA	27,530	27,530	27,530	27,530	27,530	27,530	27,530	27,530
LEM0775AC8APA	30,922	30,922	30,922	30,922	30,922	30,922	30,922	30,922
LEM0975AC8APA	32,441	32,441	32,441	32,441	32,441	32,441	32,441	32,441

Air Defrost Preferred Models with PSC Motors - 208-230/1/60

Base Model	List Price (\$US)							
	B0500	B0501	B0502	B0503	B0504	B0505	B0506	B0507
LEM0185BC8APA	13,345	13,345	13,345	13,345	13,345	13,345	13,345	13,345
LEM0225BC8APA	14,560	14,560	14,560	14,560	14,560	14,560	14,560	14,560
LEM0405BC8APA	17,919	17,919	17,919	17,919	17,919	17,919	17,919	17,919
LEM0475BC8APA	21,016	21,016	21,016	21,016	21,016	21,016	21,016	21,016
LEM0575BC8APA	24,397	24,397	24,397	24,397	24,397	24,397	24,397	24,397
LEM0675BC8APA	27,884	27,884	27,884	27,884	27,884	27,884	27,884	27,884
LEM0775BC8APA	31,383	31,383	31,383	31,383	31,383	31,383	31,383	31,383
LEM0975BC8APA	32,906	32,906	32,906	32,906	32,906	32,906	32,906	32,906
LEM1115BC8APA	36,436	36,436	36,436	36,436	36,436	36,436	36,436	36,436

Air Defrost Preferred Models with PSC Motors - 460/1/60

Base Model	List Price (\$US)							
	B0500	B0501	B0502	B0503	B0504	B0505	B0506	B0507
LEM0185MC8APA	13,690	13,690	13,690	13,690	13,690	13,690	13,690	13,690
LEM0225MC8APA	14,907	14,907	14,907	14,907	14,907	14,907	14,907	14,907
LEM0405MC8APA	18,611	18,611	18,611	18,611	18,611	18,611	18,611	18,611
LEM0475MC8APA	21,706	21,706	21,706	21,706	21,706	21,706	21,706	21,706
LEM0575MC8APA	25,422	25,422	25,422	25,422	25,422	25,422	25,422	25,422
LEM0675MC8APA	28,912	28,912	28,912	28,912	28,912	28,912	28,912	28,912
LEM0775MC8APA	32,753	32,753	32,753	32,753	32,753	32,753	32,753	32,753
LEM0975MC8APA	34,280	34,280	34,280	34,280	34,280	34,280	34,280	34,280
LEM1115MC8APA	38,151	38,151	38,151	38,151	38,151	38,151	38,151	38,151



AIR DEFROST PREFERRED MODELS

Please consult AWEF and Net Capacity table of Technical bulletin to confirm DOE compliance per model

Air Defrost Preferred Models with VSEC Motors - 115/1/60

Base Model	List Price (\$US)							
	B0500	B0501	B0502	B0503	B0504	B0505	B0506	B0507
LEM0185AC8AVA	15,218	15,218	15,218	15,218	15,218	15,218	15,218	15,218
LEM0225AC8AVA	16,495	16,495	16,495	16,495	16,495	16,495	16,495	16,495
LEM0405AC8AVA	21,579	21,579	21,579	21,579	21,579	21,579	21,579	21,579
LEM0475AC8AVA	24,812	24,812	24,812	24,812	24,812	24,812	24,812	24,812
LEM0575AC8AVA	29,909	29,909	29,909	29,909	29,909	29,909	29,909	29,909
LEM0675AC8AVA	33,554	33,554	33,554	33,554	33,554	33,554	33,554	33,554
LEM0775AC8AVA	38,793	38,793	38,793	38,793	38,793	38,793	38,793	38,793
LEM0975AC8AVA	40,378	40,378	40,378	40,378	40,378	40,378	40,378	40,378

Air Defrost Preferred Models with VSEC Motors - 208-230/1/60

Base Model	List Price (\$US)							
	B0500	B0501	B0502	B0503	B0504	B0505	B0506	B0507
LEM0185BC8AVA	15,346	15,346	15,346	15,346	15,346	15,346	15,346	15,346
LEM0225BC8AVA	16,611	16,611	16,611	16,611	16,611	16,611	16,611	16,611
LEM0405BC8AVA	21,820	21,820	21,820	21,820	21,820	21,820	21,820	21,820
LEM0475BC8AVA	25,055	25,055	25,055	25,055	25,055	25,055	25,055	25,055
LEM0575BC8AVA	30,282	30,282	30,282	30,282	30,282	30,282	30,282	30,282
LEM0675BC8AVA	33,925	33,925	33,925	33,925	33,925	33,925	33,925	33,925
LEM0775BC8AVA	39,275	39,275	39,275	39,275	39,275	39,275	39,275	39,275
LEM0975BC8AVA	40,872	40,872	40,872	40,872	40,872	40,872	40,872	40,872
LEM1115BC8AVA	46,251	46,251	46,251	46,251	46,251	46,251	46,251	46,251



ELECTRIC DEFROST PREFERRED MODELS

Please consult AWEF and Net Capacity table of Technical bulletin to confirm DOE compliance per model

Electric Defrost Preferred Models with 2 Speed EC Motors - 208-230/1/60

Base Model	List Price (\$US)							
	B0500	B0501	B0502	B0503	B0504	B0505	B0506	B0507
LEM0125BC6EMA	16,261	16,261	16,261	16,261	16,261	16,261	16,261	16,261
LEM0135BC6EMA	17,818	17,818	17,818	17,818	17,818	17,818	17,818	17,818
LEM0250BC6EMA	22,508	22,508	22,508	22,508	22,508	22,508	22,508	22,508
LEM0300BC6EMA	27,511	27,511	27,511	27,511	27,511	27,511	27,511	27,511
LEM0370BC6EMA	30,237	30,237	30,237	30,237	30,237	30,237	30,237	30,237
LEM0475BC6EMA	34,757	34,757	34,757	34,757	34,757	34,757	34,757	34,757
LEM0125BC4EMA	16,585	16,585	16,585	16,585	16,585	16,585	16,585	16,585
LEM0225BC4EMA	21,172	21,172	21,172	21,172	21,172	21,172	21,172	21,172
LEM0250BC4EMA	25,665	25,665	25,665	25,665	25,665	25,665	25,665	25,665
LEM0325BC4EMA	28,023	28,023	28,023	28,023	28,023	28,023	28,023	28,023
LEM0420BC4EMA	33,777	33,777	33,777	33,777	33,777	33,777	33,777	33,777

Electric Defrost Preferred Models with 2-Speed EC Motors - 208-230/3/60

Base Model	List Price (\$US)							
	B0500	B0501	B0502	B0503	B0504	B0505	B0506	B0507
LEM0125CC6EMA	16,261	16,261	16,261	16,261	16,261	16,261	16,261	16,261
LEM0135CC6EMA	17,818	17,818	17,818	17,818	17,818	17,818	17,818	17,818
LEM0250CC6EMA	22,508	22,508	22,508	22,508	22,508	22,508	22,508	22,508
LEM0300CC6EMA	27,511	27,511	27,511	27,511	27,511	27,511	27,511	27,511
LEM0370CC6EMA	30,237	30,237	30,237	30,237	30,237	30,237	30,237	30,237
LEM0475CC6EMA	34,757	34,757	34,757	34,757	34,757	34,757	34,757	34,757
LEM0595CC6EMA	38,146	38,146	38,146	38,146	38,146	38,146	38,146	38,146
LEM0735CC6EMA	41,714	41,714	41,714	41,714	41,714	41,714	41,714	41,714
LEM0850CC6EMA	45,210	45,210	45,210	45,210	45,210	45,210	45,210	45,210
LEM0125CC4EMA	16,585	16,585	16,585	16,585	16,585	16,585	16,585	16,585
LEM0225CC4EMA	21,172	21,172	21,172	21,172	21,172	21,172	21,172	21,172
LEM0250CC4EMA	25,665	25,665	25,665	25,665	25,665	25,665	25,665	25,665
LEM0325CC4EMA	28,023	28,023	28,023	28,023	28,023	28,023	28,023	28,023
LEM0420CC4EMA	33,777	33,777	33,777	33,777	33,777	33,777	33,777	33,777
LEM0490CC4EMA	37,082	37,082	37,082	37,082	37,082	37,082	37,082	37,082
LEM0620CC4EMA	40,445	40,445	40,445	40,445	40,445	40,445	40,445	40,445
LEM0720CC4EMA	43,914	43,914	43,914	43,914	43,914	43,914	43,914	43,914



ELECTRIC DEFROST PREFERRED MODELS

Please consult AWEF and Net Capacity table of Technical bulletin to confirm DOE compliance per model

Electric Defrost Preferred Models with 2-Speed EC Motors - 460/1/60

Base Model	List Price (\$US)							
	B0500	B0501	B0502	B0503	B0504	B0505	B0506	B0507
LEM0125MC6EMA	19,206	19,206	19,206	19,206	19,206	19,206	19,206	19,206
LEM0135MC6EMA	21,236	21,236	21,236	21,236	21,236	21,236	21,236	21,236
LEM0250MC6EMA	27,356	27,356	27,356	27,356	27,356	27,356	27,356	27,356
LEM0300MC6EMA	33,880	33,880	33,880	33,880	33,880	33,880	33,880	33,880
LEM0370MC6EMA	37,436	37,436	37,436	37,436	37,436	37,436	37,436	37,436
LEM0475MC6EMA	43,330	43,330	43,330	43,330	43,330	43,330	43,330	43,330
LEM0595MC6EMA	47,752	47,752	47,752	47,752	47,752	47,752	47,752	47,752
LEM0735MC6EMA	52,407	52,407	52,407	52,407	52,407	52,407	52,407	52,407
LEM0850MC6EMA	56,967	56,967	56,967	56,967	56,967	56,967	56,967	56,967
LEM0125MC4EMA	19,633	19,633	19,633	19,633	19,633	19,633	19,633	19,633
LEM0225MC4EMA	25,612	25,612	25,612	25,612	25,612	25,612	25,612	25,612
LEM0250MC4EMA	31,473	31,473	31,473	31,473	31,473	31,473	31,473	31,473
LEM0325MC4EMA	34,551	34,551	34,551	34,551	34,551	34,551	34,551	34,551
LEM0420MC4EMA	42,055	42,055	42,055	42,055	42,055	42,055	42,055	42,055
LEM0490MC4EMA	46,364	46,364	46,364	46,364	46,364	46,364	46,364	46,364
LEM0620MC4EMA	50,749	50,749	50,749	50,749	50,749	50,749	50,749	50,749
LEM0720MC4EMA	55,277	55,277	55,277	55,277	55,277	55,277	55,277	55,277



ELECTRIC DEFROST PREFERRED MODELS

Please consult AWEF and Net Capacity table of Technical bulletin to confirm DOE compliance per model

Electric Defrost Preferred Models with 2-Speed EC Motors - 460/3/60

Base Model	List Price (\$US)							
	B0500	B0501	B0502	B0503	B0504	B0505	B0506	B0507
LEM0125MC6EMA	19,206	19,206	19,206	19,206	19,206	19,206	19,206	19,206
LEM0135MC6EMA	21,236	21,236	21,236	21,236	21,236	21,236	21,236	21,236
LEM0250MC6EMA	27,356	27,356	27,356	27,356	27,356	27,356	27,356	27,356
LEM0300MC6EMA	33,880	33,880	33,880	33,880	33,880	33,880	33,880	33,880
LEM0370MC6EMA	37,436	37,436	37,436	37,436	37,436	37,436	37,436	37,436
LEM0475MC6EMA	43,330	43,330	43,330	43,330	43,330	43,330	43,330	43,330
LEM0595MC6EMA	47,752	47,752	47,752	47,752	47,752	47,752	47,752	47,752
LEM0735MC6EMA	52,407	52,407	52,407	52,407	52,407	52,407	52,407	52,407
LEM0850MC6EMA	56,967	56,967	56,967	56,967	56,967	56,967	56,967	56,967
LEM0125MC4EMA	19,633	19,633	19,633	19,633	19,633	19,633	19,633	19,633
LEM0225MC4EMA	25,612	25,612	25,612	25,612	25,612	25,612	25,612	25,612
LEM0250MC4EMA	31,473	31,473	31,473	31,473	31,473	31,473	31,473	31,473
LEM0325MC4EMA	34,551	34,551	34,551	34,551	34,551	34,551	34,551	34,551
LEM0420MC4EMA	42,055	42,055	42,055	42,055	42,055	42,055	42,055	42,055
LEM0490MC4EMA	46,364	46,364	46,364	46,364	46,364	46,364	46,364	46,364
LEM0620MC4EMA	50,749	50,749	50,749	50,749	50,749	50,749	50,749	50,749
LEM0720MC4EMA	55,277	55,277	55,277	55,277	55,277	55,277	55,277	55,277

CO₂ DX MEDIUM PROFILE UNIT COOLER



ELECTRIC DEFROST PREFERRED MODELS

Please consult AWEF and Net Capacity table of Technical bulletin to confirm DOE compliance per model

Electric Defrost Preferred Models with EC Motors - 208-230/1/60

Base Model	List Price (\$US)							
	B0500	B0501	B0502	B0503	B0504	B0505	B0506	B0507
LEM0125BC6EEA	15,716	15,716	15,716	15,716	15,716	15,716	15,716	15,716
LEM0135BC6EEA	17,184	17,184	17,184	17,184	17,184	17,184	17,184	17,184
LEM0250BC6EEA	21,610	21,610	21,610	21,610	21,610	21,610	21,610	21,610
LEM0300BC6EEA	26,327	26,327	26,327	26,327	26,327	26,327	26,327	26,327
LEM0370BC6EEA	28,899	28,899	28,899	28,899	28,899	28,899	28,899	28,899
LEM0475BC6EEA	33,165	33,165	33,165	33,165	33,165	33,165	33,165	33,165
LEM0125BC4EEA	16,021	16,021	16,021	16,021	16,021	16,021	16,021	16,021
LEM0225BC4EEA	20,346	20,346	20,346	20,346	20,346	20,346	20,346	20,346
LEM0250BC4EEA	24,587	24,587	24,587	24,587	24,587	24,587	24,587	24,587
LEM0325BC4EEA	26,811	26,811	26,811	26,811	26,811	26,811	26,811	26,811
LEM0420BC4EEA	32,243	32,243	32,243	32,243	32,243	32,243	32,243	32,243

Electric Defrost Preferred Models with EC Motors - 208-230/3/60

Base Model	List Price (\$US)							
	B0500	B0501	B0502	B0503	B0504	B0505	B0506	B0507
LEM0125CC6EEA	15,716	15,716	15,716	15,716	15,716	15,716	15,716	15,716
LEM0135CC6EEA	17,184	17,184	17,184	17,184	17,184	17,184	17,184	17,184
LEM0250CC6EEA	21,610	21,610	21,610	21,610	21,610	21,610	21,610	21,610
LEM0300CC6EEA	26,327	26,327	26,327	26,327	26,327	26,327	26,327	26,327
LEM0370CC6EEA	28,899	28,899	28,899	28,899	28,899	28,899	28,899	28,899
LEM0475CC6EEA	33,165	33,165	33,165	33,165	33,165	33,165	33,165	33,165
LEM0595CC6EEA	36,361	36,361	36,361	36,361	36,361	36,361	36,361	36,361
LEM0735CC6EEA	39,730	39,730	39,730	39,730	39,730	39,730	39,730	39,730
LEM0850CC6EEA	43,026	43,026	43,026	43,026	43,026	43,026	43,026	43,026
LEM0125CC4EEA	16,021	16,021	16,021	16,021	16,021	16,021	16,021	16,021
LEM0225CC4EEA	20,346	20,346	20,346	20,346	20,346	20,346	20,346	20,346
LEM0250CC4EEA	24,587	24,587	24,587	24,587	24,587	24,587	24,587	24,587
LEM0325CC4EEA	26,811	26,811	26,811	26,811	26,811	26,811	26,811	26,811
LEM0420CC4EEA	32,243	32,243	32,243	32,243	32,243	32,243	32,243	32,243
LEM0490CC4EEA	35,357	35,357	35,357	35,357	35,357	35,357	35,357	35,357
LEM0620CC4EEA	38,530	38,530	38,530	38,530	38,530	38,530	38,530	38,530
LEM0720CC4EEA	41,805	41,805	41,805	41,805	41,805	41,805	41,805	41,805



ELECTRIC DEFROST PREFERRED MODELS

Please consult AWEF and Net Capacity table of Technical bulletin to confirm DOE compliance per model

Electric Defrost Preferred Models with PSC Motors Totally Enclosed - 208-230/1/60

Base Model	List Price (\$US)							
	B0500	B0501	B0502	B0503	B0504	B0505	B0506	B0507
LEM0125BC6ECA	15,073	15,073	15,073	15,073	15,073	15,073	15,073	15,073
LEM0135BC6ECA	16,555	16,555	16,555	16,555	16,555	16,555	16,555	16,555
LEM0250BC6ECA	20,295	20,295	20,295	20,295	20,295	20,295	20,295	20,295
LEM0300BC6ECA	25,060	25,060	25,060	25,060	25,060	25,060	25,060	25,060
LEM0370BC6ECA	26,929	26,929	26,929	26,929	26,929	26,929	26,929	26,929
LEM0475BC6ECA	31,234	31,234	31,234	31,234	31,234	31,234	31,234	31,234
LEM0125BC4ECA	15,384	15,384	15,384	15,384	15,384	15,384	15,384	15,384
LEM0225BC4ECA	19,022	19,022	19,022	19,022	19,022	19,022	19,022	19,022
LEM0250BC4ECA	23,303	23,303	23,303	23,303	23,303	23,303	23,303	23,303
LEM0325BC4ECA	24,820	24,820	24,820	24,820	24,820	24,820	24,820	24,820
LEM0420BC4ECA	30,303	30,303	30,303	30,303	30,303	30,303	30,303	30,303

Electric Defrost Preferred Models with PSC Motors Totally Enclosed - 208-230/3/60

Base Model	List Price (\$US)							
	B0500	B0501	B0502	B0503	B0504	B0505	B0506	B0507
LEM0125CC6ECA	15,073	15,073	15,073	15,073	15,073	15,073	15,073	15,073
LEM0135CC6ECA	16,555	16,555	16,555	16,555	16,555	16,555	16,555	16,555
LEM0250CC6ECA	20,295	20,295	20,295	20,295	20,295	20,295	20,295	20,295
LEM0300CC6ECA	25,060	25,060	25,060	25,060	25,060	25,060	25,060	25,060
LEM0370CC6ECA	26,929	26,929	26,929	26,929	26,929	26,929	26,929	26,929
LEM0475CC6ECA	31,234	31,234	31,234	31,234	31,234	31,234	31,234	31,234
LEM0595CC6ECA	33,734	33,734	33,734	33,734	33,734	33,734	33,734	33,734
LEM0735CC6ECA	37,134	37,134	37,134	37,134	37,134	37,134	37,134	37,134
LEM0850CC6ECA	39,735	39,735	39,735	39,735	39,735	39,735	39,735	39,735
LEM0125CC4ECA	15,384	15,384	15,384	15,384	15,384	15,384	15,384	15,384
LEM0225CC4ECA	19,022	19,022	19,022	19,022	19,022	19,022	19,022	19,022
LEM0250CC4ECA	23,303	23,303	23,303	23,303	23,303	23,303	23,303	23,303
LEM0325CC4ECA	24,820	24,820	24,820	24,820	24,820	24,820	24,820	24,820
LEM0420CC4ECA	30,303	30,303	30,303	30,303	30,303	30,303	30,303	30,303
LEM0490CC4ECA	32,720	32,720	32,720	32,720	32,720	32,720	32,720	32,720
LEM0620CC4ECA	35,923	35,923	35,923	35,923	35,923	35,923	35,923	35,923
LEM0720CC4ECA	38,501	38,501	38,501	38,501	38,501	38,501	38,501	38,501



ELECTRIC DEFROST PREFERRED MODELS

Please consult AWEF and Net Capacity table of Technical bulletin to confirm DOE compliance per model

Electric Defrost Preferred Models with PSC Motors Totally Enclosed - 460/1/60

Base Model	List Price (\$US)							
	B0500	B0501	B0502	B0503	B0504	B0505	B0506	B0507
LEM0125MC6ECA	15,559	15,559	15,559	15,559	15,559	15,559	15,559	15,559
LEM0135MC6ECA	17,039	17,039	17,039	17,039	17,039	17,039	17,039	17,039
LEM0250MC6ECA	21,249	21,249	21,249	21,249	21,249	21,249	21,249	21,249
LEM0300MC6ECA	26,016	26,016	26,016	26,016	26,016	26,016	26,016	26,016
LEM0370MC6ECA	28,354	28,354	28,354	28,354	28,354	28,354	28,354	28,354
LEM0475MC6ECA	32,666	32,666	32,666	32,666	32,666	32,666	32,666	32,666
LEM0595MC6ECA	35,641	35,641	35,641	35,641	35,641	35,641	35,641	35,641
LEM0735MC6ECA	39,043	39,043	39,043	39,043	39,043	39,043	39,043	39,043
LEM0850MC6ECA	42,122	42,122	42,122	42,122	42,122	42,122	42,122	42,122
LEM0125MC4ECA	15,857	15,857	15,857	15,857	15,857	15,857	15,857	15,857
LEM0225MC4ECA	19,978	19,978	19,978	19,978	19,978	19,978	19,978	19,978
LEM0250MC4ECA	24,262	24,262	24,262	24,262	24,262	24,262	24,262	24,262
LEM0325MC4ECA	25,768	25,768	25,768	25,768	25,768	25,768	25,768	25,768
LEM0420MC4ECA	31,737	31,737	31,737	31,737	31,737	31,737	31,737	31,737
LEM0490MC4ECA	34,624	34,624	34,624	34,624	34,624	34,624	34,624	34,624
LEM0620MC4ECA	37,821	37,821	37,821	37,821	37,821	37,821	37,821	37,821
LEM0720MC4ECA	40,883	40,883	40,883	40,883	40,883	40,883	40,883	40,883



ELECTRIC DEFROST PREFERRED MODELS

Please consult AWEF and Net Capacity table of Technical bulletin to confirm DOE compliance per model

Electric Defrost Preferred Models with PSC Motors Totally Enclosed - 460/3/60

Base Model	List Price (\$US)							
	B0500	B0501	B0502	B0503	B0504	B0505	B0506	B0507
LEM0125DC6ECA	15,559	15,559	15,559	15,559	15,559	15,559	15,559	15,559
LEM0135DC6ECA	17,039	17,039	17,039	17,039	17,039	17,039	17,039	17,039
LEM0250DC6ECA	21,249	21,249	21,249	21,249	21,249	21,249	21,249	21,249
LEM0300DC6ECA	26,016	26,016	26,016	26,016	26,016	26,016	26,016	26,016
LEM0370DC6ECA	28,354	28,354	28,354	28,354	28,354	28,354	28,354	28,354
LEM0475DC6ECA	32,666	32,666	32,666	32,666	32,666	32,666	32,666	32,666
LEM0595DC6ECA	35,641	35,641	35,641	35,641	35,641	35,641	35,641	35,641
LEM0735DC6ECA	39,043	39,043	39,043	39,043	39,043	39,043	39,043	39,043
LEM0850DC6ECA	42,122	42,122	42,122	42,122	42,122	42,122	42,122	42,122
LEM0125DC4ECA	15,857	15,857	15,857	15,857	15,857	15,857	15,857	15,857
LEM0225DC4ECA	19,978	19,978	19,978	19,978	19,978	19,978	19,978	19,978
LEM0250DC4ECA	24,262	24,262	24,262	24,262	24,262	24,262	24,262	24,262
LEM0325DC4ECA	25,768	25,768	25,768	25,768	25,768	25,768	25,768	25,768
LEM0420DC4ECA	31,737	31,737	31,737	31,737	31,737	31,737	31,737	31,737
LEM0490DC4ECA	34,624	34,624	34,624	34,624	34,624	34,624	34,624	34,624
LEM0620DC4ECA	37,821	37,821	37,821	37,821	37,821	37,821	37,821	37,821
LEM0720DC4ECA	40,883	40,883	40,883	40,883	40,883	40,883	40,883	40,883

CO₂ DX MEDIUM PROFILE UNIT COOLER



ELECTRIC DEFROST PREFERRED MODELS

Please consult AWEF and Net Capacity table of Technical bulletin to confirm DOE compliance per model

Electric Defrost Preferred Models with PSC Motors Totally Enclosed - 575/3/60

Base Model	List Price (\$US)							
	B0500	B0501	B0502	B0503	B0504	B0505	B0506	B0507
LEM0125EC6ECA	15,281	15,281	15,281	15,281	15,281	15,281	15,281	15,281
LEM0135EC6ECA	16,783	16,783	16,783	16,783	16,783	16,783	16,783	16,783
LEM0250EC6ECA	20,621	20,621	20,621	20,621	20,621	20,621	20,621	20,621
LEM0300EC6ECA	25,492	25,492	25,492	25,492	25,492	25,492	25,492	25,492
LEM0370EC6ECA	27,414	27,414	27,414	27,414	27,414	27,414	27,414	27,414
LEM0475EC6ECA	31,808	31,808	31,808	31,808	31,808	31,808	31,808	31,808
LEM0595EC6ECA	34,387	34,387	34,387	34,387	34,387	34,387	34,387	34,387
LEM0735EC6ECA	37,852	37,852	37,852	37,852	37,852	37,852	37,852	37,852
LEM0850EC6ECA	40,532	40,532	40,532	40,532	40,532	40,532	40,532	40,532
LEM0125EC4ECA	15,585	15,585	15,585	15,585	15,585	15,585	15,585	15,585
LEM0225EC4ECA	19,321	19,321	19,321	19,321	19,321	19,321	19,321	19,321
LEM0250EC4ECA	23,695	23,695	23,695	23,695	23,695	23,695	23,695	23,695
LEM0325EC4ECA	24,769	24,769	24,769	24,769	24,769	24,769	24,769	24,769
LEM0420EC4ECA	30,862	30,862	30,862	30,862	30,862	30,862	30,862	30,862
LEM0490EC4ECA	33,348	33,348	33,348	33,348	33,348	33,348	33,348	33,348
LEM0620EC4ECA	36,606	36,606	36,606	36,606	36,606	36,606	36,606	36,606
LEM0720EC4ECA	39,267	39,267	39,267	39,267	39,267	39,267	39,267	39,267



ELECTRIC DEFROST PREFERRED MODELS

Please consult AWEF and Net Capacity table of Technical bulletin to confirm DOE compliance per model

Electric Defrost Preferred Models with PSC Motors - 208-230/1/60

Base Model	List Price (\$US)							
	B0500	B0501	B0502	B0503	B0504	B0505	B0506	B0507
LEM0125BC6EPA	14,622	14,622	14,622	14,622	14,622	14,622	14,622	14,622
LEM0135BC6EPA	16,105	16,105	16,105	16,105	16,105	16,105	16,105	16,105
LEM0250BC6EPA	19,392	19,392	19,392	19,392	19,392	19,392	19,392	19,392
LEM0300BC6EPA	24,159	24,159	24,159	24,159	24,159	24,159	24,159	24,159
LEM0370BC6EPA	25,575	25,575	25,575	25,575	25,575	25,575	25,575	25,575
LEM0475BC6EPA	29,880	29,880	29,880	29,880	29,880	29,880	29,880	29,880
LEM0125BC4EPA	14,934	14,934	14,934	14,934	14,934	14,934	14,934	14,934
LEM0225BC4EPA	18,118	18,118	18,118	18,118	18,118	18,118	18,118	18,118
LEM0250BC4EPA	22,403	22,403	22,403	22,403	22,403	22,403	22,403	22,403
LEM0325BC4EPA	23,466	23,466	23,466	23,466	23,466	23,466	23,466	23,466
LEM0420BC4EPA	28,947	28,947	28,947	28,947	28,947	28,947	28,947	28,947

Electric Defrost Preferred Models with PSC Motors - 208-230/3/60

Base Model	List Price (\$US)							
	B0500	B0501	B0502	B0503	B0504	B0505	B0506	B0507
LEM0125CC6EPA	14,622	14,622	14,622	14,622	14,622	14,622	14,622	14,622
LEM0135CC6EPA	16,105	16,105	16,105	16,105	16,105	16,105	16,105	16,105
LEM0250CC6EPA	19,392	19,392	19,392	19,392	19,392	19,392	19,392	19,392
LEM0300CC6EPA	24,159	24,159	24,159	24,159	24,159	24,159	24,159	24,159
LEM0370CC6EPA	25,575	25,575	25,575	25,575	25,575	25,575	25,575	25,575
LEM0475CC6EPA	29,880	29,880	29,880	29,880	29,880	29,880	29,880	29,880
LEM0595CC6EPA	31,929	31,929	31,929	31,929	31,929	31,929	31,929	31,929
LEM0735CC6EPA	35,329	35,329	35,329	35,329	35,329	35,329	35,329	35,329
LEM0850CC6EPA	37,478	37,478	37,478	37,478	37,478	37,478	37,478	37,478
LEM0125CC4EPA	14,934	14,934	14,934	14,934	14,934	14,934	14,934	14,934
LEM0225CC4EPA	18,118	18,118	18,118	18,118	18,118	18,118	18,118	18,118
LEM0250CC4EPA	22,403	22,403	22,403	22,403	22,403	22,403	22,403	22,403
LEM0325CC4EPA	23,466	23,466	23,466	23,466	23,466	23,466	23,466	23,466
LEM0420CC4EPA	28,947	28,947	28,947	28,947	28,947	28,947	28,947	28,947
LEM0490CC4EPA	30,917	30,917	30,917	30,917	30,917	30,917	30,917	30,917
LEM0620CC4EPA	34,121	34,121	34,121	34,121	34,121	34,121	34,121	34,121
LEM0720CC4EPA	36,242	36,242	36,242	36,242	36,242	36,242	36,242	36,242

CO₂ DX MEDIUM PROFILE UNIT COOLER



ELECTRIC DEFROST PREFERRED MODELS

Please consult AWEF and Net Capacity table of Technical bulletin to confirm DOE compliance per model

Electric Defrost Preferred Models with PSC Motors - 460/1/60

Base Model	List Price (\$US)							
	B0500	B0501	B0502	B0503	B0504	B0505	B0506	B0507
LEM0125MC6EPA	15,107	15,107	15,107	15,107	15,107	15,107	15,107	15,107
LEM0135MC6EPA	16,588	16,588	16,588	16,588	16,588	16,588	16,588	16,588
LEM0250MC6EPA	20,348	20,348	20,348	20,348	20,348	20,348	20,348	20,348
LEM0300MC6EPA	25,114	25,114	25,114	25,114	25,114	25,114	25,114	25,114
LEM0370MC6EPA	27,003	27,003	27,003	27,003	27,003	27,003	27,003	27,003
LEM0475MC6EPA	31,311	31,311	31,311	31,311	31,311	31,311	31,311	31,311
LEM0595MC6EPA	33,838	33,838	33,838	33,838	33,838	33,838	33,838	33,838
LEM0735MC6EPA	37,240	37,240	37,240	37,240	37,240	37,240	37,240	37,240
LEM0850MC6EPA	39,866	39,866	39,866	39,866	39,866	39,866	39,866	39,866
LEM0125MC4EPA	15,406	15,406	15,406	15,406	15,406	15,406	15,406	15,406
LEM0225MC4EPA	19,074	19,074	19,074	19,074	19,074	19,074	19,074	19,074
LEM0250MC4EPA	23,360	23,360	23,360	23,360	23,360	23,360	23,360	23,360
LEM0325MC4EPA	24,414	24,414	24,414	24,414	24,414	24,414	24,414	24,414
LEM0420MC4EPA	30,382	30,382	30,382	30,382	30,382	30,382	30,382	30,382
LEM0490MC4EPA	32,821	32,821	32,821	32,821	32,821	32,821	32,821	32,821
LEM0620MC4EPA	36,018	36,018	36,018	36,018	36,018	36,018	36,018	36,018
LEM0720MC4EPA	38,630	38,630	38,630	38,630	38,630	38,630	38,630	38,630



ELECTRIC DEFROST PREFERRED MODELS

Please consult AWEF and Net Capacity table of Technical bulletin to confirm DOE compliance per model

Electric Defrost Preferred Models with PSC Motors - 460/3/60

Base Model	List Price (\$US)							
	B0500	B0501	B0502	B0503	B0504	B0505	B0506	B0507
LEM0125DC6EPA	15,107	15,107	15,107	15,107	15,107	15,107	15,107	15,107
LEM0135DC6EPA	16,588	16,588	16,588	16,588	16,588	16,588	16,588	16,588
LEM0250DC6EPA	20,348	20,348	20,348	20,348	20,348	20,348	20,348	20,348
LEM0300DC6EPA	25,114	25,114	25,114	25,114	25,114	25,114	25,114	25,114
LEM0370DC6EPA	27,003	27,003	27,003	27,003	27,003	27,003	27,003	27,003
LEM0475DC6EPA	31,311	31,311	31,311	31,311	31,311	31,311	31,311	31,311
LEM0595DC6EPA	33,838	33,838	33,838	33,838	33,838	33,838	33,838	33,838
LEM0735DC6EPA	37,240	37,240	37,240	37,240	37,240	37,240	37,240	37,240
LEM0850DC6EPA	39,866	39,866	39,866	39,866	39,866	39,866	39,866	39,866
LEM0125DC4EPA	15,406	15,406	15,406	15,406	15,406	15,406	15,406	15,406
LEM0225DC4EPA	19,074	19,074	19,074	19,074	19,074	19,074	19,074	19,074
LEM0250DC4EPA	23,360	23,360	23,360	23,360	23,360	23,360	23,360	23,360
LEM0325DC4EPA	24,414	24,414	24,414	24,414	24,414	24,414	24,414	24,414
LEM0420DC4EPA	30,382	30,382	30,382	30,382	30,382	30,382	30,382	30,382
LEM0490DC4EPA	32,821	32,821	32,821	32,821	32,821	32,821	32,821	32,821
LEM0620DC4EPA	36,018	36,018	36,018	36,018	36,018	36,018	36,018	36,018
LEM0720DC4EPA	38,630	38,630	38,630	38,630	38,630	38,630	38,630	38,630

CO₂ DX MEDIUM PROFILE UNIT COOLER



ELECTRIC DEFROST PREFERRED MODELS

Please consult AWEF and Net Capacity table of Technical bulletin to confirm DOE compliance per model

Electric Defrost Preferred Models with PSC Motors - 575/3/60

Base Model	List Price (\$US)							
	B0500	B0501	B0502	B0503	B0504	B0505	B0506	B0507
LEM0125EC6ECA	15,281	15,281	15,281	15,281	15,281	15,281	15,281	15,281
LEM0135EC6ECA	16,783	16,783	16,783	16,783	16,783	16,783	16,783	16,783
LEM0250EC6ECA	20,621	20,621	20,621	20,621	20,621	20,621	20,621	20,621
LEM0300EC6ECA	25,492	25,492	25,492	25,492	25,492	25,492	25,492	25,492
LEM0370EC6ECA	27,414	27,414	27,414	27,414	27,414	27,414	27,414	27,414
LEM0475EC6ECA	31,808	31,808	31,808	31,808	31,808	31,808	31,808	31,808
LEM0595EC6ECA	34,387	34,387	34,387	34,387	34,387	34,387	34,387	34,387
LEM0735EC6ECA	37,852	37,852	37,852	37,852	37,852	37,852	37,852	37,852
LEM0850EC6ECA	40,532	40,532	40,532	40,532	40,532	40,532	40,532	40,532
LEM0125EC4ECA	15,585	15,585	15,585	15,585	15,585	15,585	15,585	15,585
LEM0225EC4ECA	19,321	19,321	19,321	19,321	19,321	19,321	19,321	19,321
LEM0250EC4ECA	23,695	23,695	23,695	23,695	23,695	23,695	23,695	23,695
LEM0325EC4ECA	24,769	24,769	24,769	24,769	24,769	24,769	24,769	24,769
LEM0420EC4ECA	30,862	30,862	30,862	30,862	30,862	30,862	30,862	30,862
LEM0490EC4ECA	33,348	33,348	33,348	33,348	33,348	33,348	33,348	33,348
LEM0620EC4ECA	36,606	36,606	36,606	36,606	36,606	36,606	36,606	36,606
LEM0720EC4ECA	39,267	39,267	39,267	39,267	39,267	39,267	39,267	39,267



ELECTRIC DEFROST PREFERRED MODELS

Please consult AWEF and Net Capacity table of Technical bulletin to confirm DOE compliance per model

Electric Defrost Preferred Models with VSEC Motors - 208-230/1/60

Base Model	List Price (\$US)							
	B0500	B0501	B0502	B0503	B0504	B0505	B0506	B0507
LEM0125BC6EVA	16,718	16,718	16,718	16,718	16,718	16,718	16,718	16,718
LEM0135BC6EVA	18,272	18,272	18,272	18,272	18,272	18,272	18,272	18,272
LEM0250BC6EVA	23,420	23,420	23,420	23,420	23,420	23,420	23,420	23,420
LEM0300BC6EVA	28,422	28,422	28,422	28,422	28,422	28,422	28,422	28,422
LEM0370BC6EVA	31,605	31,605	31,605	31,605	31,605	31,605	31,605	31,605
LEM0475BC6EVA	36,125	36,125	36,125	36,125	36,125	36,125	36,125	36,125
LEM0125BC4EVA	17,041	17,041	17,041	17,041	17,041	17,041	17,041	17,041
LEM0225BC4EVA	22,082	22,082	22,082	22,082	22,082	22,082	22,082	22,082
LEM0250BC4EVA	26,574	26,574	26,574	26,574	26,574	26,574	26,574	26,574
LEM0325BC4EVA	29,388	29,388	29,388	29,388	29,388	29,388	29,388	29,388
LEM0420BC4EVA	35,145	35,145	35,145	35,145	35,145	35,145	35,145	35,145

Electric Defrost Preferred Models with VSEC Motors - 208-230/3/60

Base Model	List Price (\$US)							
	B0500	B0501	B0502	B0503	B0504	B0505	B0506	B0507
LEM0125CC6EVA	16,718	16,718	16,718	16,718	16,718	16,718	16,718	16,718
LEM0135CC6EVA	18,272	18,272	18,272	18,272	18,272	18,272	18,272	18,272
LEM0250CC6EVA	23,420	23,420	23,420	23,420	23,420	23,420	23,420	23,420
LEM0300CC6EVA	28,422	28,422	28,422	28,422	28,422	28,422	28,422	28,422
LEM0370CC6EVA	31,605	31,605	31,605	31,605	31,605	31,605	31,605	31,605
LEM0475CC6EVA	36,125	36,125	36,125	36,125	36,125	36,125	36,125	36,125
LEM0595CC6EVA	39,969	39,969	39,969	39,969	39,969	39,969	39,969	39,969
LEM0735CC6EVA	43,540	43,540	43,540	43,540	43,540	43,540	43,540	43,540
LEM0850CC6EVA	47,491	47,491	47,491	47,491	47,491	47,491	47,491	47,491
LEM0125CC4EVA	17,041	17,041	17,041	17,041	17,041	17,041	17,041	17,041
LEM0225CC4EVA	22,082	22,082	22,082	22,082	22,082	22,082	22,082	22,082
LEM0250CC4EVA	26,574	26,574	26,574	26,574	26,574	26,574	26,574	26,574
LEM0325CC4EVA	29,388	29,388	29,388	29,388	29,388	29,388	29,388	29,388
LEM0420CC4EVA	35,145	35,145	35,145	35,145	35,145	35,145	35,145	35,145
LEM0490CC4EVA	38,907	38,907	38,907	38,907	38,907	38,907	38,907	38,907
LEM0620CC4EVA	42,266	42,266	42,266	42,266	42,266	42,266	42,266	42,266
LEM0720CC4EVA	45,384	45,384	45,384	45,384	45,384	45,384	45,384	45,384

CO₂ DX MEDIUM PROFILE UNIT COOLER



SHIPPED-LOOSE ACCESSORIES

Part Number	Description	List Price (US \$)
Electronic Expansion Valves (EEV)		
29330610	Valve Expansion Akv 10P0 W/O Coil	2,809
29330601	Valve Expansion Akv 10P1 W/O Coil	2,809
29330602	Valve Expansion Akv 10P2 W/O Coil	2,809
29330603	Valve Expansion Akv 10P3 W/O Coil	2,809
29330604	Valve Expansion Akv 10P4 W/O Coil	2,809
29330605	Valve Expansion Akv 10P5 W/O Coil	2,809
29330606	Valve Expansion Akv 10P6 W/O Coil	2,809
29330607	Valve Expansion Akv 10P7 W/O Coil	2,809
29326004	Valve Expansion Akv 10Ps4 W/O Coil	3,137
29326005	Valve Expansion Akv 10Ps5 W/O Coil	3,137
29326006	Valve Expansion Akv 10Ps6 W/O Coil	3,254
29326007	Valve Expansion Akv 10Ps7 W/O Coil	3,254
29390201	Valve Expansion Ser-Aa	2,429
29390101	Valve Expansion Ser-A	2,890
29389401	Valve Expansion Ser-B Cable With Strippe	1,992
29389501	Valve Expansion Ser-C With Cable With St	1,992
29389601	Valve Expansion Ser-C 4X5 Odf-10'-S, 805	1,992
29389701	Valve Expansion Ser-D 4X5 Odf-10'-S, 805	1,992
29389801	Valve Expansion Ser-D 4X7Odf-10'-S, 8052	1,992
EEV Coils		
29321201	Valve Expansion Elec Coil 208/240Vac	560
29378101	Valve Expansion Elec Xv Coil 120V 16W	558
29321303	Valve Expansion Elec Xv Coil 24Vac	960
Pressure Transducer		
28977108	Pressure Tansducer	4,006
28977045	CPC Transducer	4,867
28912701	Slo- Trans Press Microthermo 952-0008	2,266
Transducer Cable		
28912401	Cable Pressure Transducer 5M	707
Filter Drier		
22103201	Filter Drier DMT 083S, R-744 CO2	644
22103301	Filter Drier DMT 084S, R744 CO2	836
2210059	Filter Drier C-084-S 1/2SOLDER	176
4600C	Filter Drier 3/8" ODF EK-033S (22101711)	220



SHIPPED-LOOSE ACCESSORIES

Part Number	Description	List Price (US \$)
Sensors		
22524602	Temp Sensor Cpc BI5011125, Blue - Ent Air	162
22524605	Sensor Temp Cpc Red - Suc Temp	219
22524606	Temp Sensor Cpc Green (20 Ft) - Leave Air	872
22524607	Temp Sensor Orange - Def Term	162
22527201	Sensor Temperature Sensor Danfoss Ak11	446
28923072	Sensor Microthermo Probe #23-0072 - Def Term	608
28923073	Microthermo Probe #23-0073 - Ent Air	567
28923074	Sensor Microthermo Temp 23-0076 - Suc Temp	378
Defrost Control		
4267W	Adjustable Defrost Control/Fan Delay Switch	483
Drain Line Heaters		
5508Q	6 ft. Drain Line Heater (208-230V, 42 Watts)	247
5594P	12 ft. Drain Line Heater (208-230V, 84 Watts)	331
5595P	18 ft. Drain Line Heater (208-230V, 126 Watts)	435
5596P	36 ft. Drain Line Heater (208-230V, 252 Watts)	492
5597P	60 ft. Drain Line Heater (208-230V, 420 Watts)	885



GLYCOL UNIT COOLERS

Low Profile Evaporator

Low profile glycol unit coolers, are available in air or electric defrost. These units are designed to offer an environmentally-friendly product that provides maximum capacity while occupying a minimum amount of space inside a walk-in cooler or freezer. These units are ideal for many applications including restaurants and convenience stores.

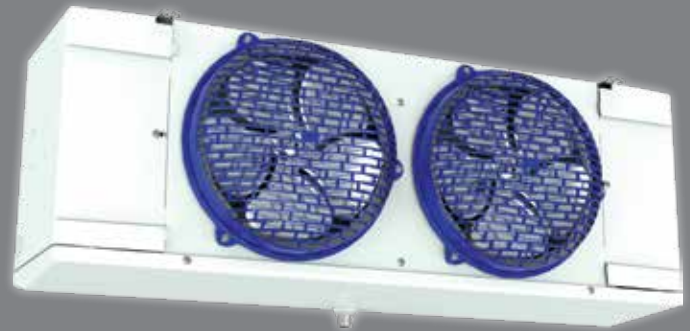

NOMENCLATURE

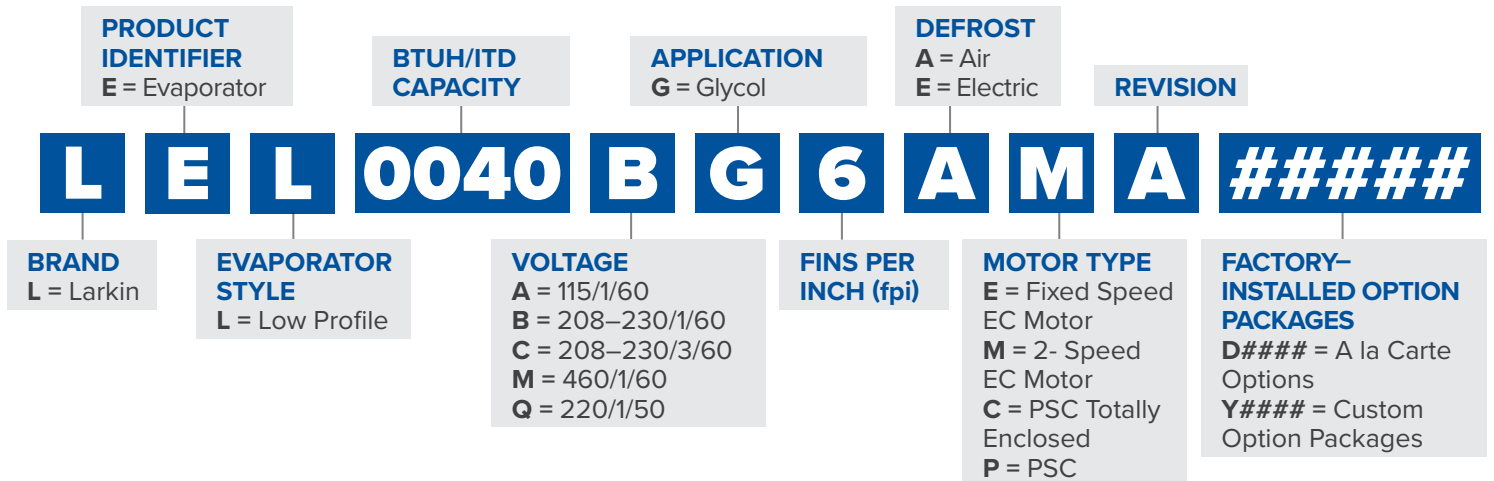

OVERVIEW

Cabinet

- Minimal height of the low profile series makes it ideal for low ceiling coolers, allowing for maximum headroom and more product storage
- Textured aluminum cabinet design features front access panels on each side for easy access to electrical and refrigeration components
- All electrical components factory wired to terminal board and identified, making it easy to field wire the unit.
- Internal panels are "isolated" which provides for quiet unit operation

Heaters & Coil

- Not supporting warm fluid defrost for Low Profile due to very low volume (ETO only).
- All warm-fluid defrost models have heater/fan control factory set and wired
- All electric defrost models include defrost termination thermostats
- Coils are dehydrated and sealed at the factory
- Sweat connections to reduce potential for leaks
- Vent and drain fittings for proper charging of system

Guards & Motors

- Featuring molded guards and a motor mount design that is optimized to minimize vibration
- Motors plug into wiring harness for easier servicing

Drain Pan

- Optimized drain fitting position

Options

- Energy-efficient PSC motors 115/1/60, 208-230/1/60 (TEAO motors are standard on 115V and special order on 230V and 460V)
- Optional Energy-Efficient EC Motors (115/1/60 or 208-230/1/60)
- 575 volt units are not available
- Available in stainless steel cabinets and/or drain pan
- Copper fin or coil coating
- Shipped loose shut-off and balance valves available.



GLYCOL UNIT COOLERS

Low Profile Evaporators

AIR DEFROST PREFERRED MODELS

2-Speed EC Motors - 115/1/60

Base Model	List Price (\$US)	Factory Installed: A la Carte Options (List Price Adder US\$)				
		Coated Coil (Black)	ProKote	Bronz-Glow	Insulated Drain Pan	Adj. Def. Control
LELO400AG6AMAB0000	5,045	1,187	1,772	2,725	300	843
LELO550AG6AMAB0000	5,246	1,187	1,772	2,725	300	843
LELO650AG6AMAB0000	5,812	1,187	1,772	2,725	300	843
LELO800AG6AMAB0000	7,836	1,733	1,809	2,725	372	843
LELO1000AG6AMAB0000	10,354	2,181	1,848	2,725	457	843
LELO1150AG6AMAB0000	12,917	2,413	1,889	3,255	503	843
LELO1350AG6AMAB0000	13,408	2,413	1,889	3,255	503	843
LELO1500AG6AMAB0000	14,896	2,746	1,926	3,620	571	843

2-Speed EC Motors - 208-230/1/60

Base Model	List Price (\$US)	Factory Installed: A la Carte Options (List Price Adder US\$)				
		Coated Coil (Black)	ProKote	Bronz-Glow	Insulated Drain Pan	Adj. Def. Control
LELO400BG6AMAB0000	5,175	1,187	1,772	2,725	300	843
LELO550BG6AMAB0000	5,371	1,187	1,772	2,725	300	843
LELO650BG6AMAB0000	5,931	1,187	1,772	2,725	300	843
LELO800BG6AMAB0000	8,028	1,733	1,809	2,725	372	843
LELO1000BG6AMAB0000	11,483	2,181	1,848	2,725	457	843
LELO1150BG6AMAB0000	14,425	2,413	1,889	3,255	503	843
LELO1350BG6AMAB0000	14,917	2,413	1,889	3,255	503	843
LELO1500BG6AMAB0000	16,606	2,746	1,926	3,620	571	843

Notes:

- Base price includes vent and drain valves.
- Plastic fan guards are standard.
- Stainless Steel Cabinet & Pan and Copper Fin Coils are available. Contact your Sales Representative or Account Engineer for more information.
- Shipped loose shut-off and balance valves available.
- Must specify which coating at time of order entry.



GLYCOL UNIT COOLERS

Low Profile Evaporators

AIR DEFROST PREFERRED MODELS

2-Speed EC Motors - 220/1/50

Base Model	List Price (\$US)	Factory Installed: A la Carte Options (List Price Adder US\$)				
		Coated Coil (Black)	ProKote	Bronz-Glow	Insulated Drain Pan	Adj. Def. Control
LEL0400QG6AMAB0000	5,175	1,187	1,772	2,725	300	843
LEL0550QG6AMAB0000	5,371	1,187	1,772	2,725	300	843
LEL0650QG6AMAB0000	5,931	1,187	1,772	2,725	300	843
LEL0800QG6AMAB0000	8,028	1,733	1,809	2,725	372	843
LEL1000QG6AMAB0000	11,483	2,181	1,848	2,725	457	843
LEL1150QG6AMAB0000	14,425	2,413	1,889	3,255	503	843
LEL1350QG6AMAB0000	14,917	2,413	1,889	3,255	503	843
LEL1500QG6AMAB0000	16,606	2,746	1,926	3,620	571	843

Fixed Speed EC Motors - 115/1/60

Base Model	List Price (\$US)	Factory Installed: A la Carte Options (List Price Adder US\$)				
		Coated Coil (Black)	ProKote	Bronz-Glow	Insulated Drain Pan	Adj. Def. Control
LEL0400AG6AEAB0000	4,856	1,187	1,772	2,725	300	843
LEL0550AG6AEAB0000	5,052	1,187	1,772	2,725	300	843
LEL0650AG6AEAB0000	5,598	1,187	1,772	2,725	300	843
LEL0800AG6AEAB0000	7,543	1,733	1,809	2,725	372	843
LEL1000AG6AEAB0000	9,968	2,181	1,848	2,725	457	843
LEL1150AG6AEAB0000	12,439	2,413	1,889	3,255	503	843
LEL1350AG6AEAB0000	12,910	2,413	1,889	3,255	503	843
LEL1500AG6AEAB0000	14,345	2,746	1,926	3,620	571	843

Notes:

- Base price includes vent and drain valves.
- Plastic fan guards are standard.
- Stainless Steel Cabinet & Pan and Copper Fin Coils are available. Contact your Sales Representative or Account Engineer for more information.
- Shipped loose shut-off and balance valves available.
- Must specify which coating at time of order entry.



GLYCOL UNIT COOLERS

Low Profile Evaporators

AIR DEFROST PREFERRED MODELS

Fixed Speed EC Motors - 208-230/1/60

Base Model	List Price (\$US)	Factory Installed: A la Carte Options (List Price Adder US\$)				
		Coated Coil (Black)	ProKote	Bronz-Glow	Insulated Drain Pan	Adj. Def. Control
LEL0400BG6AEAB0000	4,983	1,187	1,772	2,725	300	843
LEL0550BG6AEAB0000	5,174	1,187	1,772	2,725	300	843
LEL0650BG6AEAB0000	5,713	1,187	1,772	2,725	300	843
LEL0800BG6AEAB0000	7,728	1,733	1,809	2,725	372	843
LEL1000BG6AEAB0000	11,163	2,181	1,848	2,725	457	843
LEL1150BG6AEAB0000	13,891	2,413	1,889	3,255	503	843
LEL1350BG6AEAB0000	14,364	2,413	1,889	3,255	503	843
LEL1500BG6AEAB0000	15,989	2,746	1,926	3,620	571	843

Fixed Speed EC Motors - 220/1/50

Base Model	List Price (\$US)	Factory Installed: A la Carte Options (List Price Adder US\$)				
		Coated Coil (Black)	ProKote	Bronz-Glow	Insulated Drain Pan	Adj. Def. Control
LEL0400QG6AEAB0000	4,983	1,187	1,772	2,725	300	843
LEL0550QG6AEAB0000	5,174	1,187	1,772	2,725	300	843
LEL0650QG6AEAB0000	5,713	1,187	1,772	2,725	300	843
LEL0800QG6AEAB0000	7,728	1,733	1,809	2,725	372	843
LEL1000QG6AEAB0000	11,163	2,181	1,848	2,725	457	843
LEL1150QG6AEAB0000	13,891	2,413	1,889	3,255	503	843
LEL1350QG6AEAB0000	14,364	2,413	1,889	3,255	503	843
LEL1500QG6AEAB0000	15,989	2,746	1,926	3,620	571	843

Notes:

- Base price includes vent and drain valves.
- Plastic fan guards are standard.
- Stainless Steel Cabinet & Pan and Copper Fin Coils are available. Contact your Sales Representative or Account Engineer for more information.
- Shipped loose shut-off and balance valves available.
- Must specify which coating at time of order entry.



GLYCOL UNIT COOLERS

Low Profile Evaporators

AIR DEFROST PREFERRED MODELS

PSC Totally Enclosed Motors - 115/1/60

Base Model	List Price (\$US)	Factory Installed: A la Carte Options (List Price Adder US\$)				
		Coated Coil (Black)	ProKote	Bronz-Glow	Insulated Drain Pan	Adj. Def. Control
LELO400AG6ACAB0000	4,065	1,187	1,772	2,725	300	843
LELO550AG6ACAB0000	4,229	1,187	1,772	2,725	300	843
LELO650AG6ACAB0000	4,683	1,187	1,772	2,725	300	843
LELO800AG6ACAB0000	6,152	1,733	1,809	2,725	372	843
LEL1000AG6ACAB0000	8,824	2,181	1,848	2,725	457	843
LEL1150AG6ACAB0000	10,896	2,413	1,889	3,255	503	843
LEL1350AG6ACAB0000	11,295	2,413	1,889	3,255	503	843
LEL1500AG6ACAB0000	12,427	2,746	1,926	3,620	571	843

PSC Totally Enclosed Motors - 208-230/1/60

Base Model	List Price (\$US)	Factory Installed: A la Carte Options (List Price Adder US\$)				
		Coated Coil (Black)	ProKote	Bronz-Glow	Insulated Drain Pan	Adj. Def. Control
LELO400BG6ACAB0000	4,304	1,187	1,772	2,725	300	843
LELO550BG6ACAB0000	4,479	1,187	1,772	2,725	300	843
LELO650BG6ACAB0000	4,959	1,187	1,772	2,725	300	843
LELO800BG6ACAB0000	6,514	1,733	1,809	2,725	372	843
LEL1000BG6ACAB0000	9,342	2,181	1,848	2,725	457	843
LEL1150BG6ACAB0000	11,537	2,413	1,889	3,255	503	843
LEL1350BG6ACAB0000	11,959	2,413	1,889	3,255	503	843
LEL1500BG6ACAB0000	13,159	2,746	1,926	3,620	571	843

Notes:

- Base price includes vent and drain valves.
- Plastic fan guards are standard.
- Stainless Steel Cabinet & Pan and Copper Fin Coils are available. Contact your Sales Representative or Account Engineer for more information.
- Shipped loose shut-off and balance valves available.
- Must specify which coating at time of order entry.



GLYCOL UNIT COOLERS

Low Profile Evaporators

AIR DEFROST PREFERRED MODELS

PSC Totally Enclosed Motors - 460/1/60

Base Model	List Price (\$US)	Factory Installed: A la Carte Options (List Price Adder US\$)				
		Coated Coil (Black)	ProKote	Bronz-Glow	Insulated Drain Pan	Adj. Def. Control
LEL0400MG6ACAB0000	4,783	1,187	1,772	2,725	300	843
LEL0550MG6ACAB0000	4,976	1,187	1,772	2,725	300	843
LEL0650MG6ACAB0000	5,511	1,187	1,772	2,725	300	843
LEL0800MG6ACAB0000	7,239	1,733	1,809	2,725	372	843
LEL1000MG6ACAB0000	10,382	2,181	1,848	2,725	457	843
LEL1150MG6ACAB0000	12,817	2,413	1,889	3,255	503	843
LEL1350MG6ACAB0000	13,289	2,413	1,889	3,255	503	843
LEL1500MG6ACAB0000	14,622	2,746	1,926	3,620	571	843

PSC Totally Enclosed Motors - 220/1/50

Base Model	List Price (\$US)	Factory Installed: A la Carte Options (List Price Adder US\$)				
		Coated Coil (Black)	ProKote	Bronz-Glow	Insulated Drain Pan	Adj. Def. Control
LEL0400QG6ACAB0000	4,304	1,187	1,772	2,725	300	843
LEL0550QG6ACAB0000	4,479	1,187	1,772	2,725	300	843
LEL0650QG6ACAB0000	4,959	1,187	1,772	2,725	300	843
LEL0800QG6ACAB0000	6,514	1,733	1,809	2,725	372	843
LEL1000QG6ACAB0000	9,342	2,181	1,848	2,725	457	843
LEL1150QG6ACAB0000	11,537	2,413	1,889	3,255	503	843
LEL1350QG6ACAB0000	11,959	2,413	1,889	3,255	503	843
LEL1500QG6ACAB0000	13,159	2,746	1,926	3,620	571	843

Notes:

- Base price includes vent and drain valves.
- Plastic fan guards are standard.
- Stainless Steel Cabinet & Pan and Copper Fin Coils are available. Contact your Sales Representative or Account Engineer for more information.
- Shipped loose shut-off and balance valves available.
- Must specify which coating at time of order entry.



GLYCOL UNIT COOLERS

Low Profile Evaporators

ELECTRIC DEFROST PREFERRED MODELS

2-Speed EC Motors - 208-230/1/60

Base Model	List Price (\$US)	Factory Installed: A la Carte Options (List Price Adder US\$)				
		Coated Coil (Black)	ProKote	Bronz-Glow	Insulated Drain Pan	Adj. Def. Control
LELO400BG6EMAB0000	7,015	NA	NA	2,725	300	Standard
LELO550BG6EMAB0000	7,117	NA	NA	2,725	300	Standard
LELO650BG6EMAB0000	7,424	NA	NA	2,725	300	Standard
LELO800BG6EMAB0000	9,701	NA	NA	2,725	372	Standard
LEL1000BG6EMAB0000	12,603	NA	NA	2,725	457	Standard
LEL1150BG6EMAB0000	15,632	NA	NA	3,255	503	Standard
LEL1350BG6EMAB0000	16,120	NA	NA	3,255	503	Standard
LEL1500BG6EMAB0000	17,791	NA	NA	3,620	571	Standard

2-Speed EC Motors - 208-230/3/60

Base Model	List Price (\$US)	Factory Installed: A la Carte Options (List Price Adder US\$)				
		Coated Coil (Black)	ProKote	Bronz-Glow	Insulated Drain Pan	Adj. Def. Control
LELO400CG6EMAB0000	7,491	NA	NA	2,725	300	Standard
LELO550CG6EMAB0000	7,595	NA	NA	2,725	300	Standard
LELO650CG6EMAB0000	7,903	NA	NA	2,725	300	Standard
LELO800CG6EMAB0000	10,174	NA	NA	2,725	372	Standard
LEL1000CG6EMAB0000	13,072	NA	NA	2,725	457	Standard
LEL1150CG6EMAB0000	16,103	NA	NA	3,255	503	Standard
LEL1350CG6EMAB0000	16,590	NA	NA	3,255	503	Standard
LEL1500CG6EMAB0000	18,263	NA	NA	3,620	571	Standard

Notes:

- Base price includes vent and drain valves.
- Plastic fan guards are standard.
- Stainless Steel Cabinet & Pan and Copper Fin Coils are available. Contact your Sales Representative or Account Engineer for more information.
- Shipped loose shut-off and balance valves available.
- Must specify which coating at time of order entry.



GLYCOL UNIT COOLERS

Low Profile Evaporators

ELECTRIC DEFROST PREFERRED MODELS

2-Speed EC Motors - 220/1/50

Base Model	List Price (\$US)	Factory Installed: A la Carte Options (List Price Adder US\$)				
		Coated Coil (Black)	ProKote	Bronz-Glow	Insulated Drain Pan	Adj. Def. Control
LEL0400QG6EMAB0000	7,015	NA	NA	2,725	300	Standard
LEL0550QG6EMAB0000	7,117	NA	NA	2,725	300	Standard
LEL0650QG6EMAB0000	7,424	NA	NA	2,725	300	Standard
LEL0800QG6EMAB0000	9,701	NA	NA	2,725	372	Standard
LEL1000QG6EMAB0000	12,603	NA	NA	2,725	457	Standard
LEL1150QG6EMAB0000	15,632	NA	NA	3,255	503	Standard
LEL1350QG6EMAB0000	16,120	NA	NA	3,255	503	Standard
LEL1500QG6EMAB0000	17,791	NA	NA	3,620	571	Standard

Fixed Speed EC Motors - 208-230/1/60

Base Model	List Price (\$US)	Factory Installed: A la Carte Options (List Price Adder US\$)				
		Coated Coil (Black)	ProKote	Bronz-Glow	Insulated Drain Pan	Adj. Def. Control
LEL0400BG6EEAB0000	6,756	NA	NA	2,725	300	Standard
LEL0550BG6EEAB0000	6,852	NA	NA	2,725	300	Standard
LEL0650BG6EEAB0000	7,151	NA	NA	2,725	300	Standard
LEL0800BG6EEAB0000	9,432	NA	NA	2,725	372	Standard
LEL1000BG6EEAB0000	12,254	NA	NA	2,725	457	Standard
LEL1150BG6EEAB0000	15,198	NA	NA	3,255	503	Standard
LEL1350BG6EEAB0000	15,671	NA	NA	3,255	503	Standard
LEL1500BG6EEAB0000	17,295	NA	NA	3,620	571	Standard

Notes:

- Base price includes vent and drain valves.
- Plastic fan guards are standard.
- Stainless Steel Cabinet & Pan and Copper Fin Coils are available. Contact your Sales Representative or Account Engineer for more information.
- Shipped loose shut-off and balance valves available.
- Must specify which coating at time of order entry.



GLYCOL UNIT COOLERS

Low Profile Evaporators

ELECTRIC DEFROST PREFERRED MODELS

Fixed Speed EC Motors - 208-230/3/60

Base Model	List Price (\$US)	Factory Installed: A la Carte Options (List Price Adder US\$)				
		Coated Coil (Black)	ProKote	Bronz-Glow	Insulated Drain Pan	Adj. Def. Control
LEL0400CG6EEAB0000	7,213	NA	NA	2,725	300	Standard
LEL0550CG6EEAB0000	7,314	NA	NA	2,725	300	Standard
LEL0650CG6EEAB0000	7,609	NA	NA	2,725	300	Standard
LEL0800CG6EEAB0000	9,892	NA	NA	2,725	372	Standard
LEL1000CG6EEAB0000	12,708	NA	NA	2,725	457	Standard
LEL1150CG6EEAB0000	15,658	NA	NA	3,255	503	Standard
LEL1350CG6EEAB0000	16,132	NA	NA	3,255	503	Standard
LEL1500CG6EEAB0000	17,757	NA	NA	3,620	571	Standard

Fixed Speed EC Motors - 220/1/50

Base Model	List Price (\$US)	Factory Installed: A la Carte Options (List Price Adder US\$)				
		Coated Coil (Black)	ProKote	Bronz-Glow	Insulated Drain Pan	Adj. Def. Control
LEL0400QG6EEAB0000	6,756	NA	NA	2,725	300	Standard
LEL0550QG6EEAB0000	6,852	NA	NA	2,725	300	Standard
LEL0650QG6EEAB0000	7,151	NA	NA	2,725	300	Standard
LEL0800QG6EEAB0000	9,432	NA	NA	2,725	372	Standard
LEL1000QG6EEAB0000	12,254	NA	NA	2,725	457	Standard
LEL1150QG6EEAB0000	15,198	NA	NA	3,255	503	Standard
LEL1350QG6EEAB0000	15,671	NA	NA	3,255	503	Standard
LEL1500QG6EEAB0000	17,295	NA	NA	3,620	571	Standard

Notes:

- Base price includes vent and drain valves.
- Plastic fan guards are standard.
- Stainless Steel Cabinet & Pan and Copper Fin Coils are available. Contact your Sales Representative or Account Engineer for more information.
- Shipped loose shut-off and balance valves available.
- Must specify which coating at time of order entry.



GLYCOL UNIT COOLERS

Low Profile Evaporators

ELECTRIC DEFROST PREFERRED MODELS

PSC Totally Enclosed Motors - 208-230/1/60

Base Model	List Price (\$US)	Factory Installed: A la Carte Options (List Price Adder US\$)				
		Coated Coil (Black)	ProKote	Bronz-Glow	Insulated Drain Pan	Adj. Def. Control
LEL0400BG6ECAB0000	6,003	NA	NA	2,725	300	Standard
LEL0550BG6ECAB0000	6,088	NA	NA	2,725	300	Standard
LEL0650BG6ECAB0000	6,343	NA	NA	2,725	300	Standard
LEL0800BG6ECAB0000	8,030	NA	NA	2,725	372	Standard
LEL1000BG6ECAB0000	10,182	NA	NA	2,725	457	Standard
LEL1150BG6ECAB0000	12,436	NA	NA	3,255	503	Standard
LEL1350BG6ECAB0000	12,836	NA	NA	3,255	503	Standard
LEL1500BG6ECAB0000	13,969	NA	NA	3,620	571	Standard

PSC Totally Enclosed Motors - 460/1/60

Base Model	List Price (\$US)	Factory Installed: A la Carte Options (List Price Adder US\$)				
		Coated Coil (Black)	ProKote	Bronz-Glow	Insulated Drain Pan	Adj. Def. Control
LEL0400MG6ECAB0000	7,064	NA	NA	2,725	300	Standard
LEL0550MG6ECAB0000	7,162	NA	NA	2,725	300	Standard
LEL0650MG6ECAB0000	7,463	NA	NA	2,725	300	Standard
LEL0800MG6ECAB0000	9,447	NA	NA	2,725	372	Standard
LEL1000MG6ECAB0000	11,976	NA	NA	2,725	457	Standard
LEL1150MG6ECAB0000	14,630	NA	NA	3,255	503	Standard
LEL1350MG6ECAB0000	15,100	NA	NA	3,255	503	Standard
LEL1500MG6ECAB0000	16,435	NA	NA	3,620	571	Standard

Notes:

- Base price includes vent and drain valves.
- Plastic fan guards are standard.
- Stainless Steel Cabinet & Pan and Copper Fin Coils are available. Contact your Sales Representative or Account Engineer for more information.
- Shipped loose shut-off and balance valves available.
- Must specify which coating at time of order entry.



GLYCOL UNIT COOLERS

Low Profile Evaporators

ELECTRIC DEFROST PREFERRED MODELS

PSC Totally Enclosed Motors - 220/1/50

Base Model	List Price (\$US)	Factory Installed: A la Carte Options (List Price Adder US\$)				
		Coated Coil (Black)	ProKote	Bronz-Glow	Insulated Drain Pan	Adj. Def. Control
LEL0400QG6ECAB0000	6,003	NA	NA	2,725	300	Standard
LEL0550QG6ECAB0000	6,088	NA	NA	2,725	300	Standard
LEL0650QG6ECAB0000	6,343	NA	NA	2,725	300	Standard
LEL0800QG6ECAB0000	8,030	NA	NA	2,725	372	Standard
LEL1000QG6ECAB0000	10,182	NA	NA	2,725	457	Standard
LEL1150QG6ECAB0000	12,436	NA	NA	3,255	503	Standard
LEL1350QG6ECAB0000	12,836	NA	NA	3,255	503	Standard
LEL1500QG6ECAB0000	13,969	NA	NA	3,620	571	Standard

PSC Totally Enclosed Motors - 208-230/3/60

Base Model	List Price (\$US)	Factory Installed: A la Carte Options (List Price Adder US\$)				
		Coated Coil (Black)	ProKote	Bronz-Glow	Insulated Drain Pan	Adj. Def. Control
LEL0400CG6ECAB0000	6,359	NA	NA	2,725	300	Standard
LEL0550CG6ECAB0000	6,446	NA	NA	2,725	300	Standard
LEL0650CG6ECAB0000	6,717	NA	NA	2,725	300	Standard
LEL0800CG6ECAB0000	8,504	NA	NA	2,725	372	Standard
LEL1000CG6ECAB0000	10,780	NA	NA	2,725	457	Standard
LEL1150CG6ECAB0000	13,168	NA	NA	3,255	503	Standard
LEL1350CG6ECAB0000	13,590	NA	NA	3,255	503	Standard
LEL1500CG6ECAB0000	14,792	NA	NA	3,620	571	Standard

Notes:

- Base price includes vent and drain valves.
- Plastic fan guards are standard.
- Stainless Steel Cabinet & Pan and Copper Fin Coils are available. Contact your Sales Representative or Account Engineer for more information.
- Shipped loose shut-off and balance valves available.
- Must specify which coating at time of order entry.



GLYCOL UNIT COOLERS

Low Velocity Center Mount Evaporators

Low velocity glycol center mount units, are available in air defrost. These units are designed to offer an environmentally friendly product that is ideal for floral storage, fresh fruit and vegetables, dough retarding, fresh meat storage and preparations, and many other applications. The low air flow and quiet fans are classically suited for work room applications. The generous coil surface combined with close T.D.system balance provides high humidity characteristics to minimize product shrinkage and drying.

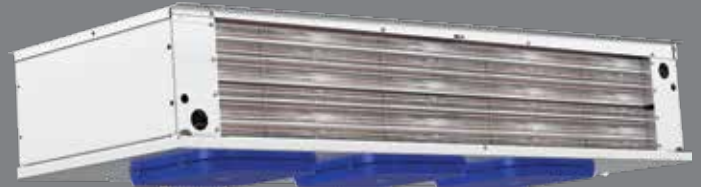

NOMENCLATURE

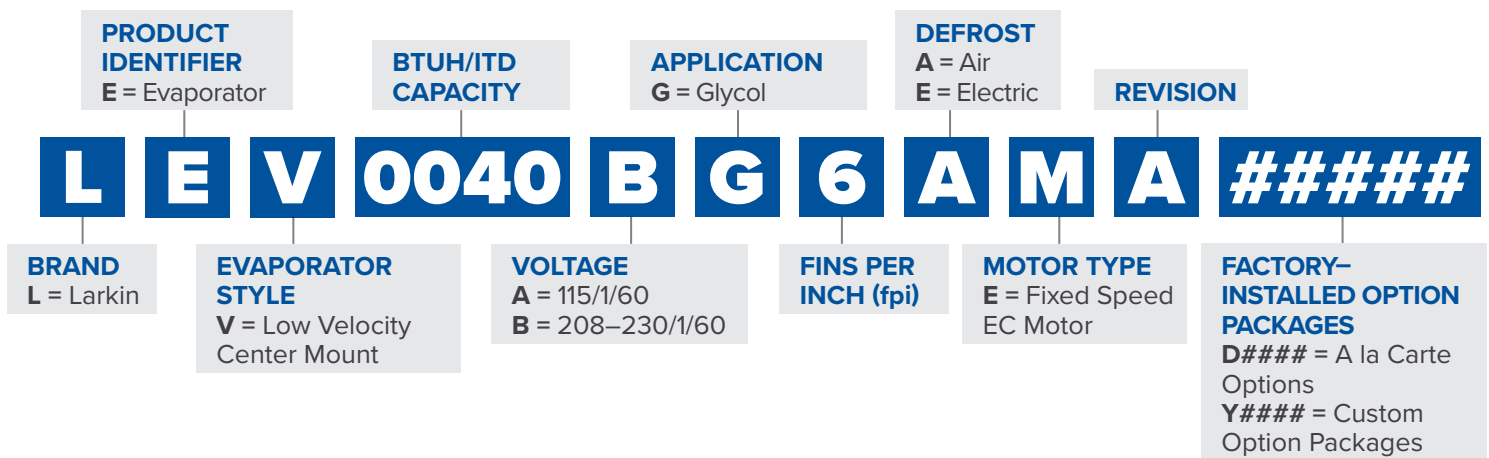

OVERVIEW

Cabinet

- Low air velocity helps to maintain high humidities and prevent product drying and weight loss; low sound makes a comfortable working environment
- Textured aluminum cabinet for maximum durability
- All electrical components factory wired to terminal board and identified, making it easy to field wire the unit.
- Internal panels are "isolated" which provides for quiet unit operation

Heaters & Coil

- Not supporting warm fluid defrost for Low Velocity Center Mount due to very low volume (ETO only).
- All warm-fluid defrost models have heater/fan control factory set and wired
- All electric defrost models include defrost termination thermostats

- Coils are dehydrated and sealed at the factory
- Sweat connections to reduce potential for leaks
- Vent and drain fittings for proper charging of system

Guards & Motors

- Wire fan guards with PVC coating provide added durability
- Motors plug into wiring harness for easier servicing

Drain Pan

- Double drain pan prevents drain pan sweatings

Options

- Energy-Efficient EC Motors (115/1/60 or 208-230/1/60)
- 575 volt units are not available
- Available in stainless steel cabinets and/or drain pan
- Copper fin or coil coating
- Shipped loose shut-off and balance valves available.



GLYCOL UNIT COOLERS

Low Velocity Center Mount Evaporators

AIR DEFROST PREFERRED MODELS

Fixed Speed EC Motors - 115/1/60

Base Model	List Price (\$US)	Factory Installed: A la Carte Options (List Price Adder US\$)		
		Coated Coil (Black)	ProKote	Bronz-Glow
LEV0400AG6AEAB0000	6,543	NA	1,736	3,477
LEV0500AG6AEAB0000	7,826	NA	1,736	3,477
LEV0750AG6AEAB0000	9,572	NA	2,562	3,477
LEV0950AG6AEAB0000	12,535	NA	2,562	5,662
LEV1100AG6AEAB0000	15,696	NA	3,491	5,662
LEV1400AG6AEAB0000	18,544	NA	4,065	6,730
LEV1650AG6AEAB0000	24,308	NA	5,517	7,796

Fixed Speed EC Motors - 208-230/1/60

Base Model	List Price (\$US)	Factory Installed: A la Carte Options (List Price Adder US\$)		
		Coated Coil (Black)	ProKote	Bronz-Glow
LEV0400BG6AEAB0000	7,226	NA	1,736	3,477
LEV0500BG6AEAB0000	8,641	NA	1,736	3,477
LEV0750BG6AEAB0000	10,508	NA	2,562	3,477
LEV0950BG6AEAB0000	13,816	NA	2,562	5,662
LEV1100BG6AEAB0000	17,214	NA	3,491	5,662
LEV1400BG6AEAB0000	20,406	NA	4,065	6,730
LEV1650BG6AEAB0000	26,705	NA	5,517	7,796

Notes:

- Base price includes vent and drain valves.
- Plastic fan guards are standard.
- Stainless Steel Cabinet & Pan and Copper Fin Coils are available. Contact your Sales Representative or Account Engineer for more information.
- Shipped loose shut-off and balance valves available.
- Must specify which coating at time of order entry.

Federal Regulation Requires EC Motors!

Energy Independence and Security Act of 2007 (H.R. 6)

Walk-Ins manufactured on or after 01/01/2009 and under 3,000 square feet in area with single phase evaporator fan motors less than 1 HP and less than 460V must be EC motors.



GLYCOL UNIT COOLERS

Low Velocity Center Mount Evaporators

AIR DEFROST PREFERRED MODELS

Fixed Speed EC Motors - 208-230/1/60

Base Model	List Price (\$US)	Factory Installed: A la Carte Options (List Price Adder US\$)		
		Coated Coil (Black)	ProKote	Bronz-Glow
LEV0400BG6EEAB0000	8,917	NA	NA	3,477
LEV0500BG6EEAB0000	10,259	NA	NA	3,477
LEV0750BG6EEAB0000	12,486	NA	NA	3,477
LEV0950BG6EEAB0000	15,624	NA	NA	5,662
LEV1100BG6EEAB0000	19,321	NA	NA	5,662
LEV1400BG6EEAB0000	22,761	NA	NA	6,730
LEV1650BG6EEAB0000	29,213	NA	NA	7,796

Notes:

- Base price includes vent and drain valves.
- Plastic fan guards are standard.
- Stainless Steel Cabinet & Pan and Copper Fin Coils are available. Contact your Sales Representative or Account Engineer for more information.
- Shipped loose shut-off and balance valves available.
- Must specify which coating at time of order entry.

Federal Regulation Requires EC Motors!

Energy Independence and Security Act of 2007 (H.R. 6)

Walk-Ins manufactured on or after 01/01/2009 and under 3,000 square feet in area with single phase evaporator fan motors less than 1 HP and less than 460V must be EC motors.



GLYCOL UNIT COOLERS

Center Mount Evaporator

Center mount glycol unit coolers are available in air defrost. They are ideal for tight storage situations because they are ceiling mount and have a height of only 8 - 5/8" allowing for maximum headroom in a cooler or freezer. The center mount design allows for product to be stacked all around while air flow distributes evenly throughout the box.

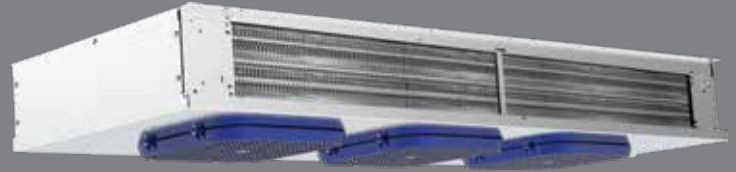

NOMENCLATURE

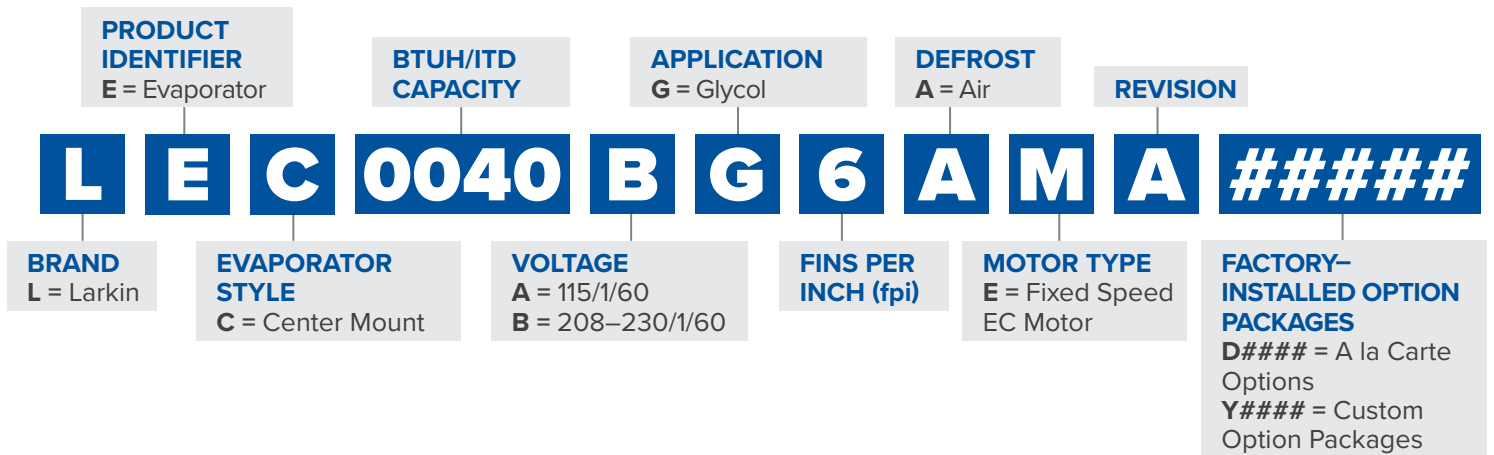

OVERVIEW

Cabinet

- Compact center-ceiling mount design allows for shelving and storage of product around walls.
- Textured aluminum cabinet for maximum durability
- All electrical components factory wired to terminal board and identified, making it easy to field wire the unit.
- Internal panels are "isolated" which provides for quiet unit operation

Heaters & Coil

- Not supporting warm fluid defrost for Center Mount due to very low volume (ETO only).
- All warm-fluid defrost models have heater/fan control factory set and wired
- All electric defrost models include defrost termination thermostats
- Coils are dehydrated and sealed at the factory

- Sweat connections to reduce potential for leaks
- Vent and drain fittings for proper charging of system

Guards & Motors

- Wire fan guards with PVC coating provide added durability
- Motors plug into wiring harness for easier servicing

Drain Pan

- Double drain pan prevents drain pan sweatings

Options

- Energy-Efficient EC Motors (115/1/60 or 208-230/1/60)
- 575 volt units are not available
- Available in stainless steel cabinets and/or drain pan
- Copper fin or coil coating
- Shipped loose shut-off and balance valves



GLYCOL UNIT COOLERS

Center Mount Evaporators

AIR DEFROST MODELS AND OPTIONS

Fixed Speed EC Motors - 115/1/60

Base Model	List Price (\$US)	Factory Installed: A la Carte Options (List Price Adder US\$)		
		BohnKote	BohnGuard	Bronz-Glow
BEC0450AG7AEAB0000	5,913	1,144	1,392	3,477
BEC0550AG7AEAB0000	7,291	1,571	1,392	3,477
BEC0600AG7AEAB0000	8,320	1,906	1,977	3,674
BEC0700AG7AEAB0000	9,235	1,906	1,977	3,916
BEC0750AG7AEAB0000	10,089	1,906	1,977	4,112
BEC0850AG7AEAB0000	11,378	2,348	2,460	4,349
BEC0950AG7AEAB0000	12,416	2,348	2,460	5,027
BEC1150AG7AEAB0000	15,366	2,994	3,168	5,705

Fixed Speed EC Motors - 208-230/1/60

Base Model	List Price (\$US)	Factory Installed: A la Carte Options (List Price Adder US\$)		
		BohnKote	BohnGuard	Bronz-Glow
BEC0450BG7AEAB0000	6,267	1,144	1,392	3,477
BEC0550BG7AEAB0000	7,650	1,571	1,392	3,477
BEC0600BG7AEAB0000	8,756	1,906	1,977	3,674
BEC0700BG7AEAB0000	9,653	1,906	1,977	3,916
BEC0750BG7AEAB0000	10,505	1,906	1,977	4,112
BEC0850BG7AEAB0000	11,866	2,348	2,460	4,349
BEC0950BG7AEAB0000	12,898	2,348	2,460	5,027
BEC1150BG7AEAB0000	15,915	2,994	3,168	5,705

Notes:

- Base price includes vent and drain valves.
- Plastic fan guards are standard.
- Stainless Steel Cabinet & Pan and Copper Fin Coils are available. Contact your Sales Representative or Account Engineer for more information.
- Shipped loose shut-off and balance valves available.
- Must specify which coating at time of order entry.

Federal Regulation Requires EC Motors!

Energy Independence and Security Act of 2007 (H.R. 6)

Walk-Ins manufactured on or after 01/01/2009 and under 3,000 square feet in area with single phase evaporator fan motors less than 1 HP and less than 460V must be EC motors.



GLYCOL UNIT COOLERS

Medium Profile Evaporators

Medium profile glycol unit coolers are available in air defrost models. These units are designed to offer an environmentally-friendly product and are ideal for numerous commercial and industrial applications. With a modular design that is only 25 inches high, these units provide superior quality and a long, dependable life to many different applications.

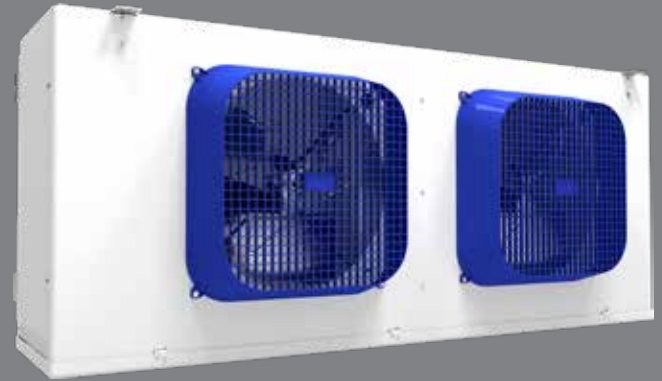

NOMENCLATURE

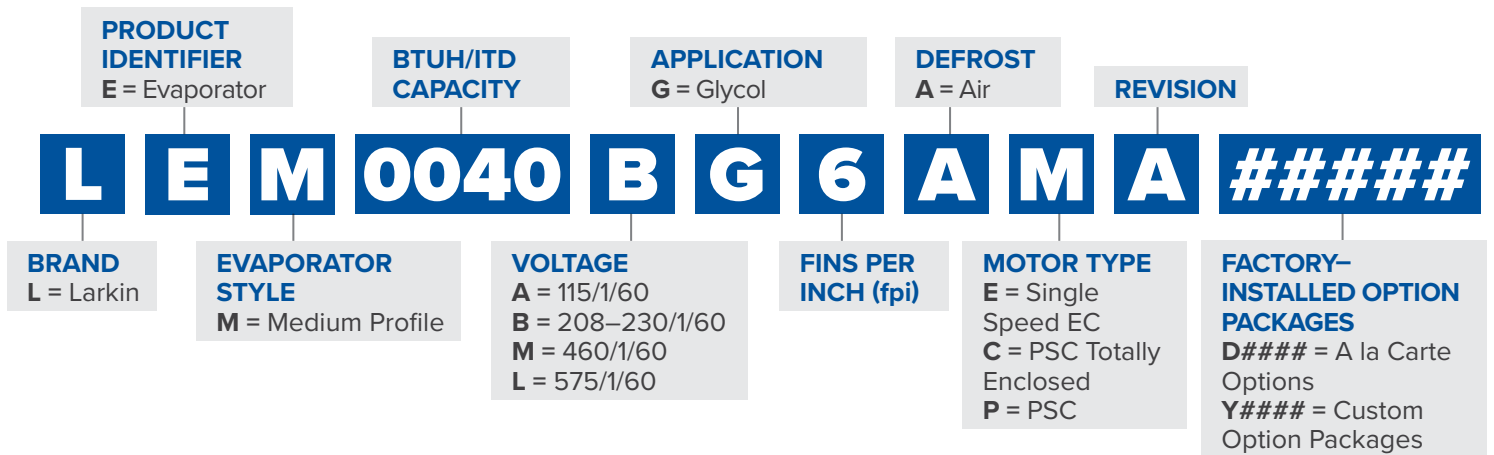

OVERVIEW

Cabinet

- Heavy-duty design is ideal for larger walk-in coolers and freezers
- Textured aluminum cabinet for maximum durability
- All electrical components factory wired to terminal board and identified, making it easy to field wire the unit.
- Internal panels are "isolated" which provides for quiet unit operation

Heaters & Coil

- All warm-fluid defrost models have heater/fan control factory set and wired
- All electric defrost models include defrost termination thermostats
- Coils are dehydrated and sealed at the factory
- Sweat connections to reduce potential for leaks
- Vent and drain fittings for proper charging of system

Guards & Motors

- Standard molded fan guards provide excellent air throw (optional wire fan guard for diffused air pattern)
- Motors plug into wiring harness for easier servicing

Drain Pan

Front hinged drain pan for easy access

Options

- PSC motors are standard (TEAO motors are special order on 230V and 460V)
- Optional Energy-Efficient EC Motors (115/1/60 or 208-230/1/60)
- Copper fin or coil coating
- Shipped loose shut-off and balance valves
- Factory-mounted balance and shut-off valves are available



GLYCOL UNIT COOLERS

Medium Profile Evaporators

AIR DEFROST PREFERRED MODELS

Fixed Speed EC Motors - 115/1/60

Base Model	List Price (\$US)	Factory Installed: A la Carte Options (List Price Adder US\$)		
		Coated Coil (Black)	ProKote	Bronz-Glow
LEM0900AG6AEAB0000	8,973	2,290	1,970	3,035
LEM1100AG6AEAB0000	12,609	2,844	2,079	4,097
LEM1275AG6AEAB0000	15,577	2,844	2,079	4,295
LEM1450AG6AEAB0000	15,915	2,844	2,079	4,295
LEM1600AG6AEAB0000	16,252	2,844	2,079	4,295
LEM1700AG6AEAB0000	19,866	3,367	2,190	5,200
LEM1900AG6AEAB0000	20,700	3,367	2,190	5,200
LEM2175AG6AEAB0000	23,863	3,367	2,190	5,200
LEM2400AG6AEAB0000	28,152	3,682	2,288	6,303
LEM2850AG6AEAB0000	30,092	3,682	2,288	6,303

Fixed Speed EC Motors - 208-230/1/60

Base Model	List Price (\$US)	Factory Installed: A la Carte Options (List Price Adder US\$)		
		Coated Coil (Black)	ProKote	Bronz-Glow
LEM0900BG6AEAB0000	9,202	2,290	1,970	3,035
LEM1100BG6AEAB0000	13,037	2,844	2,079	4,097
LEM1275BG6AEAB0000	16,004	2,844	2,079	4,295
LEM1450BG6AEAB0000	16,343	2,844	2,079	4,295
LEM1600BG6AEAB0000	16,683	2,844	2,079	4,295
LEM1700BG6AEAB0000	20,523	3,367	2,190	5,200
LEM1900BG6AEAB0000	21,376	3,367	2,190	5,200
LEM2175BG6AEAB0000	24,537	3,367	2,190	5,200
LEM2400BG6AEAB0000	29,021	3,682	2,288	6,303
LEM2850BG6AEAB0000	30,973	3,682	2,288	6,303

Notes:

- Base price includes vent and drain valves.
- Plastic fan guards are standard.
- Shipped loose shut-off and balance valves available.
- Must specify which coating at time of order entry.

Federal Regulation Requires EC Motors!

Energy Independence and Security Act of 2007 (H.R. 6)

Walk-Ins manufactured on or after 01/01/2009 and under 3,000 square feet in area with single phase evaporator fan motors less than 1 HP and less than 460V must be EC motors.



GLYCOL UNIT COOLERS

Medium Profile Evaporators

AIR DEFROST PREFERRED MODELS

PSC Totally Enclosed Motors - 208-230/1/60

Base Model	List Price (\$US)	Factory Installed: A la Carte Options (List Price Adder US\$)		
		Coated Coil (Black)	ProKote	Bronz-Glow
LEM0900BG6ACAB0000	8,170	2,290	1,970	3,035
LEM1100BG6ACAB0000	10,922	2,844	2,079	4,097
LEM1275BG6ACAB0000	13,917	2,844	2,079	4,295
LEM1450BG6ACAB0000	14,259	2,844	2,079	4,295
LEM1600BG6ACAB0000	14,603	2,844	2,079	4,295
LEM1700BG6ACAB0000	17,360	3,367	2,190	5,200
LEM1900BG6ACAB0000	18,219	3,367	2,190	5,200
LEM2175BG6ACAB0000	21,412	3,367	2,190	5,200
LEM2400BG6ACAB0000	24,821	3,682	2,288	6,303
LEM2850BG6ACAB0000	26,790	3,682	2,288	6,303
LEM3100BG6ACAB0000	29,223	4,196	2,347	7,319

PSC Totally Enclosed Motors - 460/1/60

Base Model	List Price (\$US)	Factory Installed: A la Carte Options (List Price Adder US\$)		
		Coated Coil (Black)	ProKote	Bronz-Glow
LEM0900MG6ACAB0000	8,444	2,290	1,970	3,035
LEM1100MG6ACAB0000	11,495	2,844	2,079	4,097
LEM1275MG6ACAB0000	14,486	2,844	2,079	4,295
LEM1450MG6ACAB0000	14,830	2,844	2,079	4,295
LEM1600MG6ACAB0000	15,172	2,844	2,079	4,295
LEM1700MG6ACAB0000	18,200	3,367	2,190	5,200
LEM1900MG6ACAB0000	19,050	3,367	2,190	5,200
LEM2175MG6ACAB0000	22,245	3,367	2,190	5,200
LEM2400MG6ACAB0000	25,947	3,682	2,288	6,303
LEM2850MG6ACAB0000	27,911	3,682	2,288	6,303
LEM3100MG6ACAB0000	30,843	4,196	2,347	7,319

Notes:

- Base price includes vent and drain valves.
- Plastic fan guards are standard.
- Shipped loose shut-off and balance valves available.
- Must specify which coating at time of order entry.

Federal Regulation Requires EC Motors!

Energy Independence and Security Act of 2007 (H.R. 6)

Walk-Ins manufactured on or after 01/01/2009 and under 3,000 square feet in area with single phase evaporator fan motors less than 1 HP and less than 460V must be EC motors.



GLYCOL UNIT COOLERS

Medium Profile Evaporators

AIR DEFROST PREFERRED MODELS

PSC Motors - 208-230/1/60

Base Model	List Price (\$US)	Factory Installed: A la Carte Options (List Price Adder US\$)		
		Coated Coil (Black)	ProKote	Bronz-Glow
LEM0900BG6APAB0000	8,170	2,290	1,970	3,035
LEM1100BG6APAB0000	10,922	2,844	2,079	4,097
LEM1275BG6APAB0000	13,917	2,844	2,079	4,295
LEM1450BG6APAB0000	14,259	2,844	2,079	4,295
LEM1600BG6APAB0000	14,603	2,844	2,079	4,295
LEM1700BG6APAB0000	17,360	3,367	2,190	5,200
LEM1900BG6APAB0000	18,219	3,367	2,190	5,200
LEM2175BG6APAB0000	21,412	3,367	2,190	5,200
LEM2400BG6APAB0000	24,821	3,682	2,288	6,303
LEM2850BG6APAB0000	26,790	3,682	2,288	6,303
LEM3100BG6APAB0000	29,223	4,196	2,347	7,319

PSC Motors - 460/1/60

Base Model	List Price (\$US)	Factory Installed: A la Carte Options (List Price Adder US\$)		
		Coated Coil (Black)	ProKote	Bronz-Glow
LEM0900MG6APAB0000	8,444	2,290	1,970	3,035
LEM1100MG6APAB0000	11,495	2,844	2,079	4,097
LEM1275MG6APAB0000	14,486	2,844	2,079	4,295
LEM1450MG6APAB0000	14,830	2,844	2,079	4,295
LEM1600MG6APAB0000	15,172	2,844	2,079	4,295
LEM1700MG6APAB0000	18,200	3,367	2,190	5,200
LEM1900MG6APAB0000	19,050	3,367	2,190	5,200
LEM2175MG6APAB0000	22,245	3,367	2,190	5,200
LEM2400MG6APAB0000	25,947	3,682	2,288	6,303
LEM2850MG6APAB0000	27,911	3,682	2,288	6,303
LEM3100MG6APAB0000	30,843	4,196	2,347	7,319

Notes:

- Base price includes vent and drain valves.
- Plastic fan guards are standard.
- Shipped loose shut-off and balance valves available.
- Must specify which coating at time of order entry.

Federal Regulation Requires EC Motors!

Energy Independence and Security Act of 2007 (H.R. 6)

Walk-Ins manufactured on or after 01/01/2009 and under 3,000 square feet in area with single phase evaporator fan motors less than 1 HP and less than 460V must be EC motors.



GLYCOL UNIT COOLERS

Medium Profile Evaporators

AIR DEFROST PREFERRED MODELS

PSC Motors - 575/1/60

Base Model	List Price (\$US)	Factory Installed: A la Carte Options (List Price Adder US\$)		
		Coated Coil (Black)	ProKote	Bronz-Glow
LEM0900LG6APAB0000	8,574	2,290	1,970	3,035
LEM1100LG6APAB0000	11,720	2,844	2,079	4,097
LEM1275LG6APAB0000	11,470	2,844	2,079	4,295
LEM1450LG6APAB0000	13,386	2,844	2,079	4,295
LEM1600LG6APAB0000	15,300	2,844	2,079	4,295
LEM1700LG6APAB0000	18,569	3,367	2,190	5,200
LEM1900LG6APAB0000	19,472	3,367	2,190	5,200
LEM2175LG6APAB0000	22,670	3,367	2,190	5,200
LEM2400LG6APAB0000	26,441	3,682	2,288	6,303
LEM2850LG6APAB0000	28,433	3,682	2,288	6,303
LEM3100LG6APAB0000	31,436	4,196	2,347	7,319

Notes:

- Base price includes vent and drain valves.
- Plastic fan guards are standard.
- Shipped loose shut-off and balance valves available.
- Must specify which coating at time of order entry.

Federal Regulation Requires EC Motors!

Energy Independence and Security Act of 2007 (H.R. 6)

Walk-Ins manufactured on or after 01/01/2009 and under 3,000 square feet in area with single phase evaporator fan motors less than 1 HP and less than 460V must be EC motors.



1/2 - 6 HP AIR-COOLED CONDENSING UNITS

NOMENCLATURE

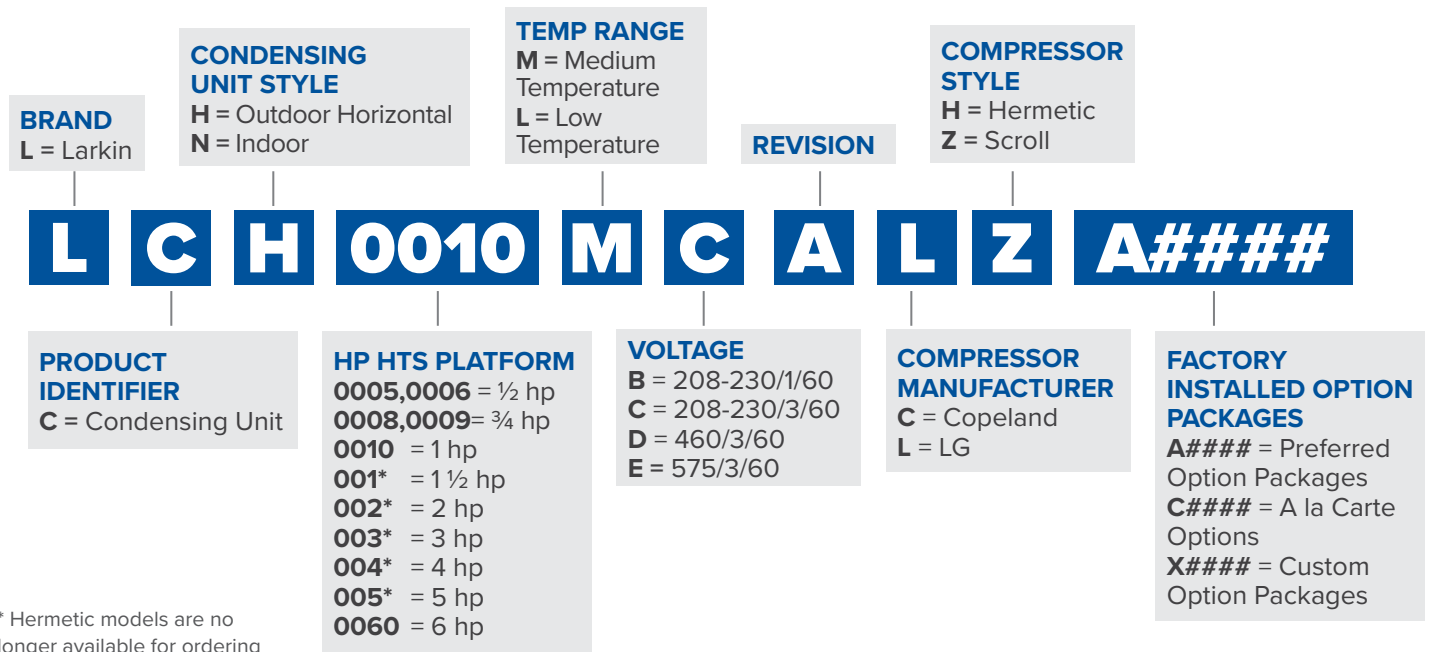

STANDARD FEATURES

- | | |
|--|---|
| <ul style="list-style-type: none"> Microchannel Coil Head Pressure Control Valve (optional for indoor models) <ul style="list-style-type: none"> • Low Temperature with Revision A is 100 psi • Low Temperature with Revision B is 145 psi • Medium Temperature with Revision A is 145 psi Crankcase Heater (optional for indoor models) Adjustable Low Pressure Control | <ul style="list-style-type: none"> Fixed High Pressure Control Sealed Liquid Line Drier (new) Liquid Line Sight Glass (new) Liquid Line and Suction Line Base Valves Painted Steel Cabinet Removable & Hinged E-box Door with Captive Fasteners |
|--|---|



1/2 - 6 HP AIR-COOLED CONDENSING UNITS

FEATURES & BENEFITS

CABINET AND CONSTRUCTION

- Microchannel coil technology standard on all units
- Painted steel cabinets for superior strength and corrosion protection
- Heavy duty, steel, 1-1/2" tall base

SERVICEABILITY

- Suction service valves for hermetic and scroll compressors located outside the cabinet for quick installations.
- Receiver with fusible plug, liquid shutoff valve and charging port is standard
- Large electrical panel for ease of access
- Prefabricated wiring harnesses for tight crimp connections and consistent labeling

- Unit stays on if the hood is removed for servicing
- Sight glass is easily viewable

QUALITY

- All units are completely leak tested in a helium environment, bump tested and allowed to cycle off on the high and low pressure control. Each unit has a copy of the run data shipped inside the electrical panel
- Electrical circuits are completely checked for continuity
- Piping is laid out to minimize stress and vibration and is pre-bent to eliminate leaks
- Encapsulated, auto-reset, high and low pressure controls to eliminate leaks (adjustable low pressure control standard on all models)

OUTSTANDING FEATURES

Base Valves

accessible without removing cabinet and access ports open to field piping

Base Legs extend full perimeter of unit for level installation

Liquid Line Filter Drier & Sight Glass standard on all units with sight glass viewable from outside cabinet

Lifting and Mounting holes in all four corners

Larger E-Box with Adjustable Low Pressure Switch standard on all units. Wiring in e-boxes secured with reusable clips

Microchannel Coil standard on all units

Hinged Door that can be removed without tools

Captive Fasteners stay on door

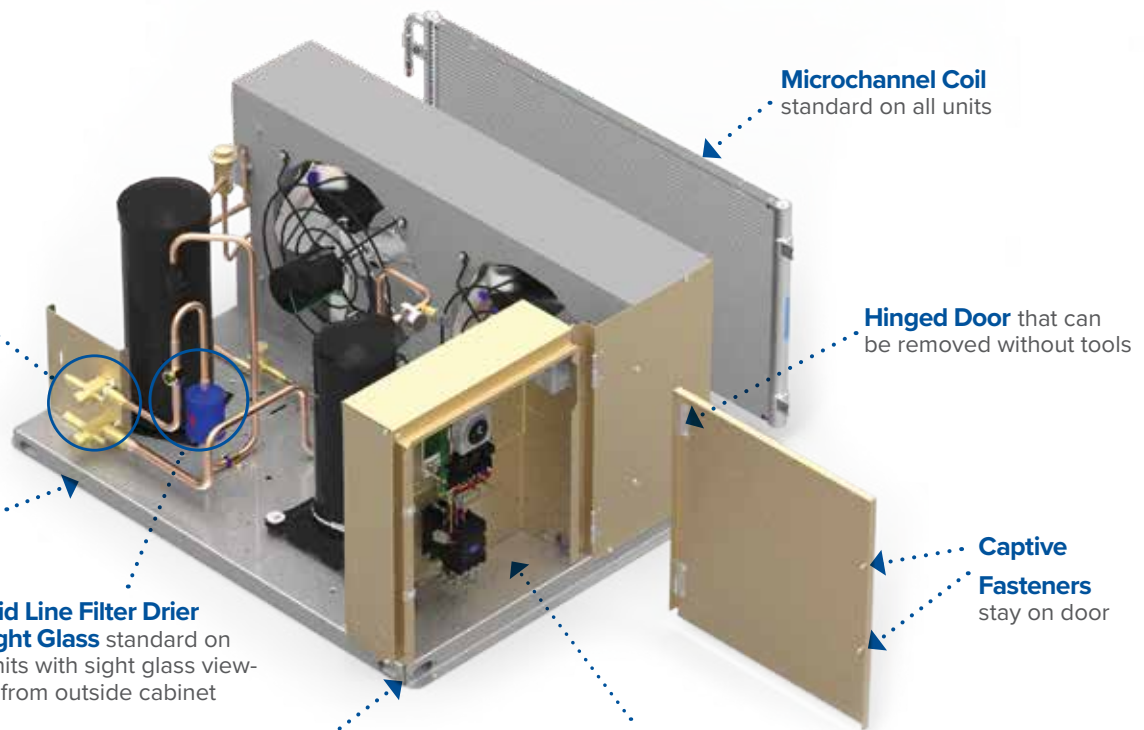

1/2 - 6 HP AIR-COOLED CONDENSING UNITS



PRECONFIGURED OUTDOOR MODELS

Note: Please see page HTS-7 for description of option package listed below.

Scroll Medium Temperature (R-404A/ R-507A/ R-407A/ R-407C/ R-448A/ R-449A)

Larkin Model	Preconfigured Outdoor				Voltage	Cabinet
	A0000 Models List Price (US \$)	A0100 Models List Price (US \$)	A0200 Models List Price (US \$)	A0300 Models List Price (US \$)		
LCH0005MBACZ	10,652	11,543	11,543	-	208-230/1/60	C1
LCH0005MCACZ	10,797	11,688	11,688	-	208-230/3/60	C1
LCH0008MBACZ	11,667	12,558	12,558	-	208-230/1/60	C1
LCH0008MCACZ	11,830	12,721	12,721	-	208-230/3/60	C1
LCH0009MBACZ	12,206	13,097	13,097	-	208-230/1/60	C1
LCH0009MCACZ	12,375	13,266	13,266	-	208-230/3/60	C1
LCH0010MBACZ	12,984	13,875	13,875	-	208-230/1/60	C1
LCH0010MBALZ	12,575	13,466	13,466	-	208-230/1/60	C1
LCH0010MCACZ	12,941	13,832	13,832	-	208-230/3/60	C1
LCH0010MCALZ	12,531	13,422	13,422	-	208-230/3/60	C1
LCH0010MDACZ	14,343	15,234	15,234	-	460/3/60	C1
LCH0010MDALZ	13,886	14,777	14,777	-	460/3/60	C1
LCH0012MBACZ	13,777	14,668	14,668	-	208-230/1/60	C2
LCH0012MCACZ	13,626	14,517	14,517	-	208-230/3/60	C2
LCH0012MDACZ	15,108	15,999	15,999	-	460/3/60	C2
LCH0015MBACZ	14,569	15,460	15,460	-	208-230/1/60	C2
LCH0015MBALZ	14,106	14,997	14,997	-	208-230/1/60	C2
LCH0015MCACZ	14,310	15,201	15,201	-	208-230/3/60	C2
LCH0015MCALZ	13,859	14,750	14,750	-	208-230/3/60	C2
LCH0015MDACZ	15,873	16,764	16,764	-	460/3/60	C2
LCH0015MDALZ	15,370	16,261	16,261	-	460/3/60	C2
LCH0015MEACZ	16,599	17,490	17,490	-	575/3/60	C2
LCH0020MBACZ	14,585	15,476	15,476	-	208-230/1/60	C2
LCH0020MBALZ	14,121	15,012	15,012	-	208-230/1/60	C2
LCH0020MCACZ	14,691	15,582	15,582	-	208-230/3/60	C2
LCH0020MCALZ	14,224	15,115	15,115	-	208-230/3/60	C2
LCH0020MDACZ	15,487	16,378	16,378	-	460/3/60	C2
LCH0020MDALZ	14,994	15,885	15,885	-	460/3/60	C2
LCH0020MEACZ	16,190	17,081	17,081	-	575/3/60	C2
LCH0025MBACZ	14,876	15,767	15,767	-	208-230/1/60	C2
LCH0025MBALZ	14,401	15,292	15,292	-	208-230/1/60	C2
LCH0025MCACZ	15,086	15,977	15,977	-	208-230/3/60	C2
LCH0025MCALZ	14,606	15,497	15,497	-	208-230/3/60	C2
LCH0025MDACZ	15,892	16,783	16,783	-	460/3/60	C2
LCH0025MDALZ	15,383	16,274	16,274	-	460/3/60	C2
LCH0025MEACZ	16,501	17,392	17,392	-	575/3/60	C2
LCH0027MBACZ	15,507	16,398	16,398	16,777	208-230/1/60	C3
LCH0027MCACZ	15,758	16,649	16,649	17,028	208-230/3/60	C3
LCH0027MDACZ	16,498	17,389	17,389	17,768	460/3/60	C3
LCH0027MEACZ	17,130	18,021	18,021	18,400	575/3/60	C3



1/2 - 6 HP AIR-COOLED CONDENSING UNITS

PRECONFIGURED OUTDOOR MODELS

Note: Please see page HTS-7 for description of option package listed below.

Scroll Medium Temperature (R-404A/ R-507A/ R-407A/ R-407C/ R-448A/ R-449A)

Larkin Model	Preconfigured Outdoor				Voltage	Cabinet
	A0000 Models List Price (US \$)	A0100 Models List Price (US \$)	A0200 Models List Price (US \$)	A0300 Models List Price (US \$)		
LCH0030MBACZ	16,136	17,027	17,027	17,406	208-230/1/60	C3
LCH0030MBALZ	15,625	16,516	16,516	16,895	208-230/1/60	C3
LCH0030MCACZ	16,430	17,321	17,321	17,700	208-230/3/60	C3
LCH0030MCALZ	15,907	16,798	16,798	17,177	208-230/3/60	C3
LCH0030MDACZ	17,102	17,993	17,993	18,372	460/3/60	C3
LCH0030MDALZ	16,558	17,449	17,449	17,828	460/3/60	C3
LCH0030MEACZ	17,759	18,650	18,650	19,029	575/3/60	C3
LCH0035MBACZ	17,807	18,698	18,698	19,077	208-230/1/60	C3
LCH0035MBALZ	17,238	18,129	18,129	18,508	208-230/1/60	C3
LCH0035MCACZ	18,096	18,987	18,987	19,366	208-230/3/60	C3
LCH0035MCALZ	17,517	18,408	18,408	18,787	208-230/3/60	C3
LCH0035MDACZ	18,769	19,660	19,660	20,039	460/3/60	C3
LCH0035MDALZ	18,170	19,061	19,061	19,440	460/3/60	C3
LCH0035MEACZ	19,453	20,344	20,344	20,723	575/3/60	C3
LCH0045MBACZ	18,061	18,952	18,952	19,331	208-230/1/60	C3
LCH0045MBALZ	17,483	18,374	18,374	18,753	208-230/1/60	C3
LCH0045MCACZ	17,689	18,580	18,580	18,959	208-230/3/60	C3
LCH0045MCALZ	17,125	18,016	18,016	18,395	208-230/3/60	C3
LCH0045MDACZ	19,542	20,433	20,433	20,812	460/3/60	C3
LCH0045MDALZ	18,915	19,806	19,806	20,185	460/3/60	C3
LCH0045MEACZ	20,276	21,167	21,167	21,546	575/3/60	C3
LCH0050MBACZ	19,554	20,445	20,445	20,824	208-230/1/60	C3
LCH0050MBALZ	18,926	19,817	19,817	20,196	208-230/1/60	C3
LCH0050MCACZ	19,151	20,042	20,042	20,421	208-230/3/60	C3
LCH0050MCALZ	18,538	19,429	19,429	19,808	208-230/3/60	C3
LCH0050MDACZ	21,160	22,051	22,051	22,430	460/3/60	C3
LCH0050MDALZ	20,481	21,372	21,372	21,751	460/3/60	C3
LCH0050MEACZ	21,948	22,839	22,839	23,218	575/3/60	C3
LCH0055MBACZ	20,432	21,323	21,323	21,702	208-230/1/60	C3
LCH0055MBALZ	19,777	20,668	20,668	21,047	208-230/1/60	C3
LCH0055MCACZ	20,736	21,627	21,627	22,006	208-230/3/60	C3
LCH0055MCALZ	20,067	20,958	20,958	21,337	208-230/3/60	C3
LCH0055MDACZ	21,402	22,293	22,293	22,672	460/3/60	C3
LCH0055MDALZ	20,714	21,605	21,605	21,984	460/3/60	C3
LCH0055MEACZ	22,047	22,938	22,938	23,317	575/3/60	C3
LCH0060MCACZ	23,102	23,993	23,993	24,372	208-230/3/60	C3
LCH0060MCALZ	22,355	23,246	23,246	23,625	208-230/3/60	C3
LCH0060MDACZ	23,773	24,664	24,664	25,043	460/3/60	C3
LCH0060MDALZ	23,003	23,894	23,894	24,273	460/3/60	C3
LCH0060MEACZ	24,722	25,613	25,613	25,992	575/3/60	C3

1/2 - 6 HP AIR-COOLED CONDENSING UNITS



PRECONFIGURED OUTDOOR MODELS

Note: Please see page HTS-7 for description of option package listed below.

Scroll Low Temperature (R-404A/ R-507A/ R-407A/ R-407C/ R-448A/ R-449A)

Larkin Model	Preconfigured Outdoor				Voltage	Cabinet
	A0000 Models List Price (US \$)	A0100 Models List Price (US \$)	A0200 Models List Price (US \$)	A0300 Models List Price (US \$)		
LCH0006LBACZ	12,525	13,416	13,416	-	208-230/1/60	C1
LCH0006LCACZ	12,715	13,606	13,606	-	208-230/3/60	C1
LCH0008LBBCZ	13,137	14,028	14,028	-	208-230/1/60	C1
LCH0008LCBCZ	13,337	14,228	14,228	-	208-230/3/60	C1
LCH0008LDBCZ	13,871	14,762	14,762	-	460/3/60	C1
LCH0010LBBCZ	13,799	14,690	14,690	-	208-230/1/60	C1
LCH0010LCBCZ	14,007	14,898	14,898	-	208-230/3/60	C1
LCH0010LDBCZ	14,567	15,458	15,458	-	460/3/60	C1
LCH0018LBBCZ	14,270	15,161	15,161	-	208-230/1/60	C1
LCH0018LCBCZ	14,486	15,377	15,377	-	208-230/3/60	C1
LCH0018LDBCZ	15,063	15,954	15,954	-	460/3/60	C1
LCH0022LBBCZ	14,740	15,631	15,631	-	208-230/1/60	C1
LCH0022LCBCZ	14,964	15,855	15,855	-	208-230/3/60	C1
LCH0022LDBCZ	15,558	16,449	16,449	-	460/3/60	C1
LCH0025LBACZ	16,304	17,195	17,195	-	208-230/1/60	C2
LCH0025LCACZ	16,594	17,485	17,485	-	208-230/3/60	C2
LCH0025LDACZ	17,406	18,297	18,297	-	460/3/60	C2
LCH0030LBACZ	16,881	17,772	17,772	-	208-230/1/60	C2
LCH0030LCBCZ	17,193	18,084	18,084	-	208-230/3/60	C2
LCH0030LDBCZ	18,009	18,900	18,900	-	460/3/60	C2
LCH0030LEBCZ	19,693	20,584	20,584	-	575/3/60	C2
LCH0035LBACZ	18,530	19,421	19,421	-	208-230/1/60	C2
LCH0035LCBCZ	18,819	19,710	19,710	-	208-230/3/60	C2
LCH0035LDBCZ	19,642	20,533	20,533	-	460/3/60	C2
LCH0035LEBCZ	20,501	21,392	21,392	-	575/3/60	C2
LCH0045LBBCZ	20,763	21,654	21,654	22,033	208-230/1/60	C3
LCH0045LCBCZ	21,048	21,939	21,939	22,318	208-230/3/60	C3
LCH0045LDBCZ	21,692	22,583	22,583	22,962	460/3/60	C3
LCH0045LEBCZ	22,483	23,374	23,374	23,753	575/3/60	C3
LCH0055LBBCZ	21,404	22,295	22,295	22,674	208-230/1/60	C3
LCH0055LCBCZ	21,749	22,640	22,640	23,019	208-230/3/60	C3
LCH0055LDBCZ	22,337	23,228	23,228	23,607	460/3/60	C3
LCH0060LCACZ	23,065	23,956	23,956	24,335	208-230/3/60	C3
LCH0060LDACZ	23,706	24,597	24,597	24,976	460/3/60	C3
LCH0060LEACZ	25,201	26,092	26,092	26,471	575/3/60	C3



1/2 - 6 HP AIR-COOLED CONDENSING UNITS

FACTORY INSTALLED: PREFERRED OPTION PACKAGES

Heatcraft now offers pre-defined kits that represent frequently ordered options or combinations of options. The preferred kits make it easier for customers to configure their units and may provide a savings over factory installed a la carte option selections.

Option Code	Description (All Preferred options include Standard Base+)	List Adder (\$US)		
		Cabinet Sizes		
		C1	C2	C3
A0100	Timer - Air	891	891	891
A0200	Timer - Electric	891	891	891
A0300	Timer - Contactor	-	-	1,270
A0400	intelliGen™/ Beacon II	1,146	1,146	1,146
A0800	Timer - Air - Paragon + Aluminum Fin/Copper Tube Coil	1,470	2,074	3,228
A0900	intelliGen™/ Beacon II + Filter	1,679	1,778	1,778
A1000	Accumulator	657	1,115	1,115
A1200	Precharged R404A	1,143	1,368	1,670
A1204	Precharged R448A	1,143	1,368	1,670

*Fixed Speed EC Motor

1/2 - 6 HP AIR-COOLED CONDENSING UNITS



STANDARD CONFIGURABLE MODELS

Configurable Models	
Standard Base Outdoor	Standard Base Indoor
<ul style="list-style-type: none"> • Prepainted Galvanized Cabinet • Microchannel Coil • Head Pressure Control Valve (optional for indoor models) -150 psi standard (except Low Temperature Scroll models which are 100 psi) • Crankcase Heater • Adjustable Low/Fixed High Pressure Control • Sealed Liquid Line Filter Drier • Liquid Line Sight Glass • Liquid Line And Suction Line Base Valves 	<ul style="list-style-type: none"> • Prepainted Galvanized Cabinet • Microchannel Coil • Adjustable Low/Fixed High Pressure Control • Sealed Liquid Line Filter Drier • Liquid Line Sight Glass • Liquid Line And Suction Line Base Valves
<p>Need to customize? Look at the factory-installed options starting on page HTS-11.</p>	

Scroll Medium Temperature (R-404A/ R-507A/ R-407A/ R-407C/ R-448A/ R-449A)

Standard Base Outdoor		Standard Base Indoor		Voltage	Cabinet
Larkin Model	List Price (US \$)	Larkin Model	List Price (US \$)		
LCH0005MBACZ	10,652	LCN0005MBACZ	9,822	208-230/1/60	C1
LCH0005MCACZ	10,797	LCN0005MCACZ	9,968	208-230/3/60	C1
LCH0008MBACZ	11,667	LCN0008MBACZ	10,837	208-230/1/60	C1
LCH0008MCACZ	11,830	LCN0008MCACZ	10,997	208-230/3/60	C1
LCH0009MBACZ	12,206	LCN0009MBACZ	11,374	208-230/1/60	C1
LCH0009MCACZ	12,375	LCN0009MCACZ	11,543	208-230/3/60	C1
LCH0010MBACZ	12,984	LCN0010MBACZ	12,153	208-230/1/60	C1
LCH0010MBALZ	12,575	LCN0010MBALZ	11,745	208-230/1/60	C1
LCH0010MCACZ	12,941	LCN0010MCACZ	12,109	208-230/3/60	C1
LCH0010MCALZ	12,531	LCN0010MCALZ	11,702	208-230/3/60	C1
LCH0010MDACZ	14,343	LCN0010MDACZ	13,513	460/3/60	C1
LCH0010MDALZ	13,886	LCN0010MDALZ	13,055	460/3/60	C1
LCH0012MBACZ	13,777	LCN0012MBACZ	12,945	208-230/1/60	C2
LCH0012MCACZ	13,626	LCN0012MCACZ	12,794	208-230/3/60	C2
LCH0012MDACZ	15,108	LCN0012MDACZ	14,278	460/3/60	C2
LCH0015MBACZ	14,569	LCN0015MBACZ	13,736	208-230/1/60	C2
LCH0015MBALZ	14,106	LCN0015MBALZ	13,274	208-230/1/60	C2
LCH0015MCACZ	14,310	LCN0015MCACZ	13,478	208-230/3/60	C2
LCH0015MCALZ	13,859	LCN0015MCALZ	13,025	208-230/3/60	C2
LCH0015MDACZ	15,873	LCN0015MDACZ	15,043	460/3/60	C2
LCH0015MDALZ	15,370	LCN0015MDALZ	14,537	460/3/60	C2
LCH0015MEACZ	16,599	LCN0015MEACZ	15,769	575/3/60	C2
LCH0020MBACZ	14,585	LCN0020MBACZ	13,756	208-230/1/60	C2
LCH0020MBALZ	14,121	LCN0020MBALZ	13,290	208-230/1/60	C2
LCH0020MCACZ	14,691	LCN0020MCACZ	13,862	208-230/3/60	C2
LCH0020MCALZ	14,224	LCN0020MCALZ	13,393	208-230/3/60	C2
LCH0020MDACZ	15,487	LCN0020MDACZ	14,659	460/3/60	C2
LCH0020MDALZ	14,994	LCN0020MDALZ	14,164	460/3/60	C2
LCH0020MEACZ	16,190	LCN0020MEACZ	15,363	575/3/60	C2
LCH0025MBACZ	14,876	LCN0025MBACZ	14,044	208-230/1/60	C2
LCH0025MBALZ	14,401	LCN0025MBALZ	13,571	208-230/1/60	C2
LCH0025MCACZ	15,086	LCN0025MCACZ	14,256	208-230/3/60	C2
LCH0025MCALZ	14,606	LCN0025MCALZ	13,773	208-230/3/60	C2
LCH0025MDACZ	15,892	LCN0025MDACZ	15,062	460/3/60	C2
LCH0025MDALZ	15,383	LCN0025MDALZ	14,553	460/3/60	C2



1/2 - 6 HP AIR-COOLED CONDENSING UNITS

STANDARD CONFIGURABLE MODELS

Scroll Medium Temperature (R-404A/ R-507A/ R-407A/ R-407C/ R-448A/ R-449A)

Standard Base Outdoor		Standard Base Indoor		Voltage	Cabinet
Larkin Model	List Price (US \$)	Larkin Model	List Price (US \$)		
LCH0025MEACZ	16,501	LCN0025MEACZ	15,670	575/3/60	C2
LCH0027MBACZ	15,507	LCN0027MBACZ	14,674	208-230/1/60	C3
LCH0027MCACZ	15,758	LCN0027MCACZ	14,927	208-230/3/60	C3
LCH0027MDACZ	16,498	LCN0027MDACZ	15,666	460/3/60	C3
LCH0027MEACZ	17,130	LCN0027MEACZ	16,308	575/3/60	C3
LCH0030MBACZ	16,136	LCN0030MBACZ	15,305	208-230/1/60	C3
LCH0030MBALZ	15,625	LCN0030MBALZ	14,793	208-230/1/60	C3
LCH0030MCACZ	16,430	LCN0030MCACZ	15,597	208-230/3/60	C3
LCH0030MCALZ	15,907	LCN0030MCALZ	15,076	208-230/3/60	C3
LCH0030MDACZ	17,102	LCN0030MDACZ	16,270	460/3/60	C3
LCH0030MDALZ	16,558	LCN0030MDALZ	15,728	460/3/60	C3
LCH0030MEACZ	17,759	LCN0030MEACZ	16,945	575/3/60	C3
LCH0035MBACZ	17,807	LCN0035MBACZ	16,974	208-230/1/60	C3
LCH0035MBALZ	17,238	LCN0035MBALZ	16,407	208-230/1/60	C3
LCH0035MCACZ	18,096	LCN0035MCACZ	17,265	208-230/3/60	C3
LCH0035MCALZ	17,517	LCN0035MCALZ	16,688	208-230/3/60	C3
LCH0035MDACZ	18,769	LCN0035MDACZ	17,937	460/3/60	C3
LCH0035MDALZ	18,170	LCN0035MDALZ	17,340	460/3/60	C3
LCH0035MEACZ	19,453	LCN0035MEACZ	18,638	575/3/60	C3
LCH0045MBACZ	18,061	LCN0045MBACZ	17,231	208-230/1/60	C3
LCH0045MBALZ	17,483	LCN0045MBALZ	16,652	208-230/1/60	C3
LCH0045MCACZ	17,689	LCN0045MCACZ	16,858	208-230/3/60	C3
LCH0045MCALZ	17,125	LCN0045MCALZ	16,294	208-230/3/60	C3
LCH0045MDACZ	19,542	LCN0045MDACZ	18,710	460/3/60	C3
LCH0045MDALZ	18,915	LCN0045MDALZ	18,083	460/3/60	C3
LCH0045MEACZ	20,276	LCN0045MEACZ	20,116	575/3/60	C3
LCH0050MBACZ	19,554	LCN0050MBACZ	18,720	208-230/1/60	C3
LCH0050MBALZ	18,926	LCN0050MBALZ	18,096	208-230/1/60	C3
LCH0050MCACZ	19,151	LCN0050MCACZ	18,320	208-230/3/60	C3
LCH0050MCALZ	18,538	LCN0050MCALZ	17,707	208-230/3/60	C3
LCH0050MDACZ	21,160	LCN0050MDACZ	20,330	460/3/60	C3
LCH0050MDALZ	20,481	LCN0050MDALZ	19,649	460/3/60	C3
LCH0050MEACZ	21,948	LCN0050MEACZ	21,142	575/3/60	C3
LCH0055MBACZ	20,432	LCN0055MBACZ	19,602	208-230/1/60	C3
LCH0055MBALZ	19,777	LCN0055MBALZ	18,948	208-230/1/60	C3
LCH0055MCACZ	20,736	LCN0055MCACZ	19,906	208-230/3/60	C3
LCH0055MCALZ	20,067	LCN0055MCALZ	19,235	208-230/3/60	C3
LCH0055MDACZ	21,402	LCN0055MDACZ	20,572	460/3/60	C3
LCH0055MDALZ	20,714	LCN0055MDALZ	19,882	460/3/60	C3
LCH0055MEACZ	22,047	LCN0055MEACZ	21,228	575/3/60	C3
LCH0060MCACZ	23,102	LCN0060MCACZ	22,271	208-230/3/60	C3
LCH0060MCALZ	22,355	LCN0060MCALZ	21,525	208-230/3/60	C3
LCH0060MDACZ	23,773	LCN0060MDACZ	22,944	460/3/60	C3
LCH0060MDALZ	23,003	LCN0060MDALZ	22,174	460/3/60	C3
LCH0060MEACZ	24,722	LCN0060MEACZ	23,912	575/3/60	C3

1/2 - 6 HP AIR-COOLED CONDENSING UNITS



STANDARD CONFIGURABLE MODELS

Scroll Low Temperature (R-404A/ R-507A/ R-407A/ R-407C/ R-448A/ R-449A)

Standard Base Outdoor		Standard Base Indoor		Voltage	Cabinet
Larkin Model	List Price (US \$)	Larkin Model	List Price (US \$)		
LCH0006LBACZ	12,525	LCN0006LBACZ	11,696	208-230/1/60	C1
LCH0006LCACZ	12,715	LCN0006LCACZ	11,883	208-230/3/60	C1
LCH0008LBBCZ	13,137	LCN0008LBACZ	12,309	208-230/1/60	C1
LCH0008LCBCZ	13,337	LCN0008LCACZ	12,507	208-230/3/60	C1
LCH0008LDBCZ	13,871	LCN0008LDACZ	13,039	460/3/60	C1
LCH0010LBBCZ	13,799	LCN0010LBACZ	12,968	208-230/1/60	C1
LCH0010LCBCZ	14,007	LCN0010LCACZ	13,176	208-230/3/60	C1
LCH0010LDBCZ	14,567	LCN0010LDACZ	13,735	460/3/60	C1
LCH0018LBBCZ	14,270	LCN0018LBACZ	13,439	208-230/1/60	C1
LCH0018LCBCZ	14,486	LCN0018LCACZ	13,655	208-230/3/60	C1
LCH0018LDBCZ	15,063	LCN0018LDACZ	14,232	460/3/60	C1
LCH0022LBBCZ	14,740	LCN0022LBACZ	13,910	208-230/1/60	C1
LCH0022LCBCZ	14,964	LCN0022LCACZ	14,133	208-230/3/60	C1
LCH0022LDBCZ	15,558	LCN0022LDACZ	14,727	460/3/60	C1
LCH0025LBACZ	16,304	LCN0025LBACZ	15,474	208-230/1/60	C2
LCH0025LCACZ	16,594	LCN0025LCACZ	15,763	208-230/3/60	C2
LCH0025LDACZ	17,406	LCN0025LDACZ	16,577	460/3/60	C2
LCH0030LBACZ	16,881	LCN0030LBACZ	16,048	208-230/1/60	C2
LCH0030LCBCZ	17,193	LCN0030LCACZ	16,362	208-230/3/60	C2
LCH0030LDBCZ	18,009	LCN0030LDACZ	17,178	460/3/60	C2
LCH0030LEBCZ	19,693	LCN0030LEACZ	18,848	575/3/60	C2
LCH0035LBACZ	18,530	LCN0035LBACZ	17,701	208-230/1/60	C2
LCH0035LCBCZ	18,819	LCN0035LCACZ	17,990	208-230/3/60	C2
LCH0035LDBCZ	19,642	LCN0035LDACZ	18,812	460/3/60	C2
LCH0035LEBCZ	20,501	LCN0035LEACZ	19,666	575/3/60	C2
LCH0045LBBCZ	20,763	LCN0045LBACZ	19,932	208-230/1/60	C3
LCH0045LCBCZ	21,048	LCN0045LCACZ	20,220	208-230/3/60	C3
LCH0045LDBCZ	21,692	LCN0045LDACZ	20,862	460/3/60	C3
LCH0045LEBCZ	22,483	LCN0045LEACZ	21,662	575/3/60	C3
LCH0055LBBCZ	21,404	LCN0055LBACZ	20,574	208-230/1/60	C3
LCH0055LCBCZ	21,749	LCN0055LCACZ	20,919	208-230/3/60	C3
LCH0055LDBCZ	22,337	LCN0055LDACZ	21,505	460/3/60	C3
LCH0055LEBCZ	23,208	LCN0055LEACZ	22,391	575/3/60	C3
LCH0060LCACZ	23,065	LCN0060LCACZ	22,234	208-230/3/60	C3
LCH0060LDACZ	23,706	LCN0060LDACZ	22,874	460/3/60	C3
LCH0060LEACZ	25,201	LCN0060LEACZ	24,397	575/3/60	C3



FACTORY INSTALLED: A LA CARTE OPTIONS

Electrical Options

Option Code	Description	List Price (US\$)			Notes
		C1	C2	C3	
DFT.AIR TIMER	Air Defrost Timer	938	938	938	Medium Temperature models only Standard on A0100 models
DFT.ELEC TIMER	Electric Defrost Timer	938	938	938	Standard on A0200 models
DFT.ELEC TIMER_CONT	Electric Defrost Timer & Contactor	–	–	1,337	Available on C3 Cabinet only Standard on A0300 models
DFT.ELEC TIMER_SDK	Electric Defrost Timer with Smart Defrost Kit™	2,390	2,390	2,390	
DFT.ELEC TIMER_SDK_CONT	Electric Defrost Timer and Contactor with Smart Defrost Kit™	–	–	–	Available on C3 Cabinet only
DFT.50 HZ ELEC TIMER	50 Hz Electric Defrost Timer	938	938	938	
DFT.50 HZ ELEC TIMER_CONT	50 Hz Electric Defrost Timer & Contactor	–	–	1,337	Available on C3 Cabinet only
DFT.INTELLIGEN_BEACON	intelliGen™/Beacon II	1,206	1,206	1,206	
SW.DUAL PRESSURE CONTROL	Dual Pressure Control with superhose	584	584	584	
SW.ADJ LOW_FIXED HIGH_JCI	Adjustable Low - Fixed High (JCI)	259	259	259	
FSD.AIR FUSED DISCONNECT	Air Defrost - Fused Disconnect	1,860	1,860	1,860	
FSD.ELEC FUSED DISCONNECT	Electric Defrost - Fused Disconnect	2,610	2,610	2,610	
PLM.PLM	Phase Loss Monitor	1,842	1,842	1,842	
MS.VSEC*	Variable Speed EC Motor with Orbus Cntl'r & Hd Press Valve	1,450	2,151	1,954	
MS.VSEC	Variable Speed EC Motor with Orbus Controller and Check Valve in Lieu of Hd Press Valve	799	1,545	1,368	
MS.FSEC	Fixed Speed EC Motor	–	1,165	1,615	Standard on C1 Cabinet



1/2 - 6 HP AIR-COOLED CONDENSING UNITS

FACTORY INSTALLED: A LA CARTE OPTIONS

Mechanical Options

Option Code	Description	List Price (US\$)			Notes
		C1	C2	C3	
LIQ.FILTER_SG_SV	Filter Drier, Sight Glass, and Solenoid Valve	999	999	999	
LIQ.FILTER_SG_RCFD	Replaceable Core Filter Drier and Sight Glass	–	–	859	Available on C3 Cabinet only
LIQ.FILTER_SG_RCFD_SV	Replaceable Core Filter Drier, Sight Glass, and Solenoid Valve	–	–	1,855	Available on C3 Cabinet only
SUC.ACCUMULATOR	Suction Accumulator	692	1,174	1,174	
SUC.FILTER	Suction Line Filter	561	665	665	
SUC.FILTER_ACCUM	Suction Line Filter and Accumulator	1,253	1,839	1,839	
SUC.FILTER_RC	Replaceable Core Suction Line Filter	–	–	1,955	Available on C3 Cabinet only
SUC.FILTER_RC_ACCUM	Replaceable Core Suction Line Filter and Accumulator	–	–	3,129	Available on C3 Cabinet only
DIS.OIL SEPARATOR, NO HPV	Oil Separator No Head Pressure Valve	–	–	2,113	Available on C3 Cabinet only
DIS.OIL SEPARATOR, HPV 100 PSI	Oil Separator Head Pressure Valve 100 PSI			2,113	Available on C3 Cabinet only
DIS.OIL SEPARATOR, HPV 145 PSI	Oil Separator Head Pressure Valve 145 PSI			2,113	Available on C3 Cabinet only
DIS.ADJ HPV	Adjustable Head Pressure Valve	483	483	1,421	
DIS.OIL SEPARATOR_ADJ HPV	Oil Separator, Adjustable Head Pressure Valve	–	–	2,633	Available on C3 Cabinet only
REC.STD RECEIVER_LOW AMB	Standard receiver with low ambient kit (heated/insulated receiver & low pressure bypass time delay relay)	1,173	1,173	1,173	
REC.OVS RECEIVER	Oversized Receiver	–	1,619	2,078	Not available on C1 Cabinet
REC.OVS RECEIVER_LOW AMB	Oversized receiver with low ambient kit (heated/insulated receiver & low pressure bypass time delay relay)	–	2,791	3,251	Not available on C1 Cabinet
PRE.PRECHARGE_R404A	Precharged - R404A with Quick Connects	1,203	1,440	1,758	
PRE.PRECHARGE_R407A	Precharged - R407A with Quick Connects	1,203	1,440	1,758	Not available for Hermetic compressor models
PRE.PRECHARGE_R448A	Precharged - R448A with Quick Connects	1,203	1,440	1,758	Not available for Hermetic compressor models
CS.ECOAT MCHX COIL	Ecoat Microchannel coil	1,403	1,762	2,379	
CS.ALM RTPF COIL	Round Tube Plate Fin Aluminum Coil	609	1,245	2,460	
CS.CPR RTPF COIL	Round Tube Plate Fin Copper Coil	3,774	4,661	8,165	
CS.PRO RTPF COIL	Round Tube Plate Fin BohnGuard Coil	2,431	3,164	4,448	
HG.HAIL GUARD_ INSTALLED	Hail Guard-Factory Installed	427	475	1,004	
LEG.12INCH SNOW LEGS	12 inch snow legs	287	287	287	

1/2 - 6 HP AIR-COOLED CONDENSING UNITS



SHIPPED-LOOSE ACCESSORIES

A wide range of shipped-loose accessories are available to order. Can't find something? Other options and accessories might be available on a custom order basis. Please contact your local Sales Representative or Account Engineer for assistance.

Option Code	Description	List Price (\$US)
29318012	Solenoid Valve, 1/2 ODF, 120/240V	589
8049918	Precharge Lineset, 7 Feet, 3/8 OD & 5/8 OD	1,089
8049919	Precharge Lineset, 7 Feet, 3/8 OD & 7/8 OD	1,135
8049920	Precharge Lineset, 7 Feet, 1/2 OD & 1-1/8 OD	1,305
8049933	Precharge Lineset, 10 Feet, 3/8 OD & 5/8 OD	1,089
8049934	Precharge Lineset, 10 Feet, 3/8 OD & 7/8 OD	1,186
8049935	Precharge Lineset, 10 Feet, 1/2 OD & 1-1/8 OD	1,517
8049921	Precharge Lineset, 15 Feet, 3/8 OD & 5/8 OD	1,174
8049922	Precharge Lineset, 15 Feet, 3/8 OD & 7/8 OD	1,269
8049923	Precharge Lineset, 15 Feet, 1/2 OD & 1-1/8 OD	1,758
8049930	Precharge Lineset, 20 Feet, 3/8 OD & 5/8 OD	1,166
8049931	Precharge Lineset, 20 Feet, 3/8 OD & 7/8 OD	1,418
8049932	Precharge Lineset, 20 Feet, 1/2 OD & 1-1/8 OD	2,018
8049924	Precharge Lineset, 30 Feet, 3/8 OD & 5/8 OD	1,490
8049925	Precharge Lineset, 30 Feet, 3/8 OD & 7/8 OD	2,006
8049926	Precharge Lineset, 30 Feet, 1/2 OD & 1-1/8 OD	2,490
8049927	Precharge Lineset, 50 Feet, 3/8 OD & 5/8 OD	2,005
8049928	Precharge Lineset, 50 Feet, 3/8 OD & 7/8 OD	3,031
8049929	Precharge Lineset, 50 Feet, 1/2 OD & 1-1/8 OD	3,732
8077893	Wire Harness, 10 Feet, 4 Conductors, X,N,3,4	537
5009969	Wire Harness, 15 Feet, 4 Conductors, X,N,3,4	641
8077894	Wire Harness, 20 Feet, 4 Conductors, X,N,3,4	692
5009970	Wire Harness, 25 Feet, 4 Conductors, X,N,3,4	810
8077895	Wire Harness, 35 Feet, 4 Conductors, X,N,3,4	936
8077896	Wire Harness, 55 Feet, 4 Conductors, X,N,3,4	1,101
Hail Guard		
59320202	Hail Guard, C1 Cabinet	1,339
59301902	Hail Guard, C2 Cabinet	1,388
59316302	Hail Guard, C3 Cabinet	1,926

SHIPPED-LOOSE ACCESSORIES

Crankcase Pressure Regulator (CPR) Valves

A selection program must be used to pick the proper valve. The selection program requires the following inputs: system capacity, suction temperature, and maximum holding temperature. Not available for use on Beacon II™ Outdoor units. Should not be used with MOP type expansion valves in unit coolers. Please contact your local Sales Representative or Account Engineer for assistance.

Size	Part Number	List Price (\$US)
5/8"	2930142	522
7/8"	29346101	715
1 1/8"	29399012	1,053
1 3/8"	29394306	4,009

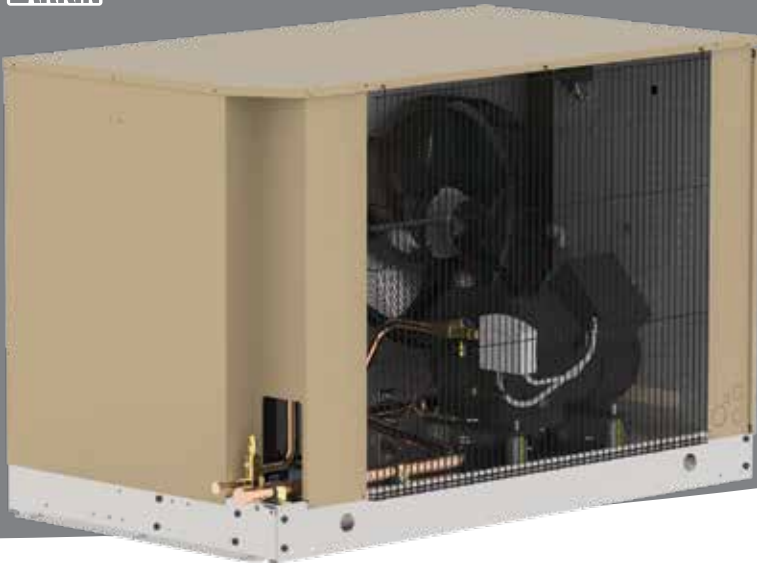

3 - 22 HP AIR-COOLED CONDENSING UNITS

NOMENCLATURE

<p>BRAND L = Larkin</p>	<p>CONDENSING UNIT STYLE H = Outdoor Horizontal N = Indoor Horizontal</p>	<p>TEMP RANGE M = Medium Temperature L = Low Temperature</p>	<p>REVISION</p>	<p>COMPRESSOR STYLE D = Discus™ Z = Scroll X = Bitzer Semi-Hermetic</p>
L C H 0030 L C A C D A####				
<p>PRODUCT IDENTIFIER C = Condensing Unit</p>	<p>HP 0030 = 3 hp 0080 = 8 hp 0040 = 4 hp 0086 = 8.5 hp 0041 = 4 hp 0090 = 9 hp 0050 = 5 hp 0091 = 9 hp 0051 = 5 hp 0100 = 10 hp 0056 = 5.5 hp 0101 = 10 hp 0060 = 6 hp 0120 = 12 hp 0061 = 6 hp 0121 = 12 hp 0062 = 6 hp 0130 = 13 hp 0065 = 6.5 hp 0131 = 13 hp 0070 = 7 hp 0141 = 14 hp 0075 = 7.5 hp 0150 = 15 hp 0076 = 7.5 hp 0220 = 22 hp</p>	<p>VOLTAGE C = 208-230/3/60 D = 460/3/60 E = 575/3/60</p>	<p>COMPRESSOR MANUFACTURER C = Copeland B = Bitzer</p>	<p>FACTORY INSTALLED OPTION PACKAGES A#### = Preferred Option Packages C#### = A la Carte Options X#### = Custom Option Packages</p>

STANDARD FEATURES

- ServiceMate™ Diagnostic Module
- Manual Pump down switch
- Electronic Oil Failure Switch (Discus™ Compressors Only)
- Fixed Head pressure control valve (C4 & C5 cabinets only)
 - Low Temperature with Revision A is 100 psi
 - Low Temperature with Revision B is 145 psi
 - Medium Temperature with Revision A is 145 psi
- Crankcase Heater
- Adjustable head pressure control valve (C6 cabinet only)

- Spring mounted compressors with suction and discharge vibration eliminators (Discus™ and Bitzer Compressors only)
- Adjustable Low Pressure Control
- Fixed High Pressure Control
- Liquid Line Sight Glass
- Permanent Liquid Line filter
- Outdoor Painted Cabinets
- Floating Tube™ design



FEATURES & BENEFITS

BETTER PERFORMANCE

- Enhanced grill design gives 25% to 40% increase in free-air area
- Electrical box located out of air stream
- Vertical receiver needs less refrigerant for liquid seal

FASTER ACCESS

- Base valve and high & low pressure taps on outside of unit
- Removable grill for access to all serviceable parts
- Improved access to fan motors & components
- Lighter, one-piece top
- Easy-to-view sight glass location

EASIER SERVICE

- Better access to components for easier repair
- Compact design allows for better jobsite placement & installation
- Dual isolation valves on receiver

GREATER RELIABILITY

- Floating Tube™ coil design eliminates tube-sheet leaks
- Pre-bent tubing reduces mechanical joints
- State-of-the-art factory leak-detection ensures highest quality

OUTSTANDING FEATURES

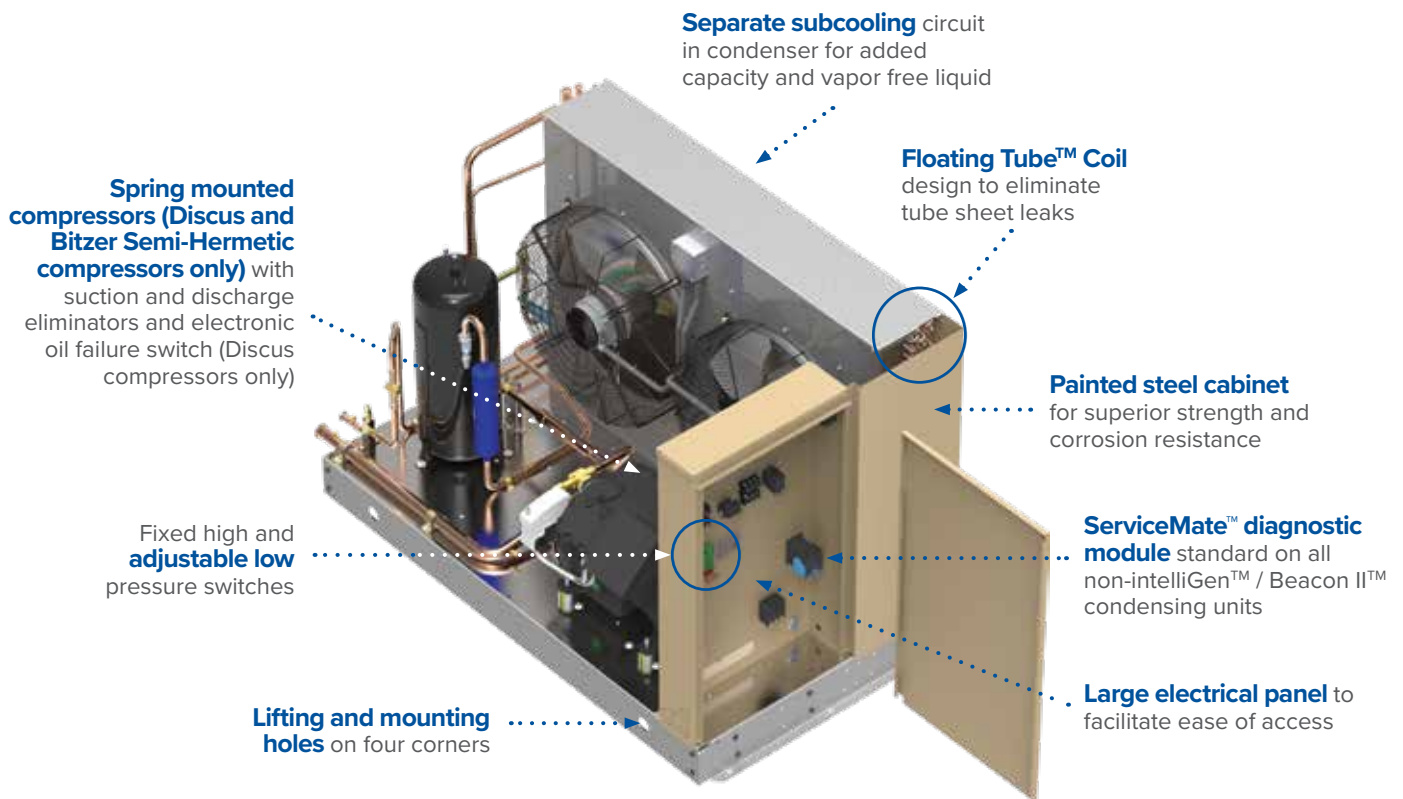

3 - 22 HP AIR-COOLED CONDENSING UNITS



PRECONFIGURED OUTDOOR MODELS

Note: Please see page HCU-6 for description of option packages.

Scroll Medium Temperature (R-404A/ R-507A/ R-407A/ R-407C/ R-407F/ R-448A/ R-449A)

Preconfigured Outdoor		Voltage	Cabinet	Preconfigured Outdoor		Voltage	Cabinet
Larkin Model	A0000 Models List Price (US \$)			Larkin Model	A0000 Models List Price (US \$)		
LCH0065MCACZ	39,756	208-230/3/60	C4	LCH0086MCACZ	54,186	208-230/3/60	C5
LCH0065MDACZ	42,339	460/3/60	C4	LCH0086MDACZ	55,479	460/3/60	C5
LCH0065MEACZ	43,185	575/3/60	C4	LCH0086MEACZ	56,588	575/3/60	C5
LCH0070MCACZ	41,399	208-230/3/60	C5	LCH0100MCACZ	56,474	208-230/3/60	C5
LCH0070MDACZ	44,088	460/3/60	C5	LCH0100MDACZ	56,933	460/3/60	C5
LCH0070MEACZ	45,024	575/3/60	C5	LCH0100MEACZ	58,073	575/3/60	C5
LCH0075MCACZ	43,332	208-230/3/60	C5	LCH0141MCACZ	66,527	208-230/3/60	C6
LCH0075MDACZ	46,018	460/3/60	C5	LCH0141MDACZ	69,111	460/3/60	C6
LCH0075MEACZ	46,935	575/3/60	C5	LCH0141MEACZ	68,367	575/3/60	C6

Scroll Low Temperature (R-404A/ R-507A/ R-407A/ R-407C/ R-407F/ R-448A/ R-449A)

Preconfigured Outdoor		Voltage	Cabinet	Preconfigured Outdoor		Voltage	Cabinet
Larkin Model	A0000 Models List Price (US \$)			Larkin Model	A0000 Models List Price (US \$)		
LCH0075LCACZ	39,188	208-230/3/60	C4	LCH0130LCBCZ	57,427	208-230/3/60	C5
LCH0075LDACZ	41,601	460/3/60	C4	LCH0130LDBCZ	58,792	460/3/60	C5
LCH0075LEACZ	42,432	575/3/60	C4	LCH0130LEBCZ	59,972	575/3/60	C5
LCH0100LCBCZ	48,645	208-230/3/60	C4	LCH0150LCBCZ	59,305	208-230/3/60	C5
LCH0100LDBCZ	51,170	460/3/60	C4	LCH0150LDBCZ	60,674	460/3/60	C5
LCH0100LEBCZ	52,192	575/3/60	C4	LCH0150LEBCZ	61,885	575/3/60	C5



PRECONFIGURED OUTDOOR MODELS

Note: Please see page HCU-6 for description of option packages.

Discus Medium Temperature (R-404A/ R-507A/ R-407A/ R-407C/ R-407F/ R-448A/ R-449A)

Preconfigured Outdoor		Voltage	Cabinet	Preconfigured Outdoor		Voltage	Cabinet
Larkin Model	A0000 Models List Price (US \$)			Larkin Model	A0000 Models List Price (US \$)		
LCH0050MCACD	38,015	208-230/3/60	C4	LCH0080MCACD	55,045	208-230/3/60	C5
LCH0050MDACD	40,531	460/3/60	C4	LCH0080MDACD	57,668	460/3/60	C5
LCH0050MEACD	41,343	575/3/60	C4	LCH0080MEACD	58,823	575/3/60	C5
LCH0051MCACD	38,961	208-230/3/60	C4	LCH0100MCACD	57,659	208-230/3/60	C5
LCH0051MDACD	41,478	460/3/60	C4	LCH0100MDACD	61,767	460/3/60	C5
LCH0051MEACD	42,305	575/3/60	C4	LCH0100MEACD	63,002	575/3/60	C5
LCH0075MCACD	45,434	208-230/3/60	C4	LCH0120MCACD	62,424	208-230/3/60	C5
LCH0075MDACD	47,814	460/3/60	C4	LCH0120MDACD	65,092	460/3/60	C5
LCH0075MEACD	48,775	575/3/60	C4	LCH0150MCACD	63,940	208-230/3/60	C6
LCH0076MCACD	47,493	208-230/3/60	C5	LCH0150MDACD	66,946	460/3/60	C6
LCH0076MDACD	49,965	460/3/60	C5	LCH0150MEACD	68,286	575/3/60	C6
LCH0076MEACD	50,962	575/3/60	C5				

Discus Low Temperature[†] (R-404A/ R-507A/ R-407A/ R-407C/ R-407F/ R-448A/ R-449A)

Preconfigured Outdoor		Voltage	Cabinet	Preconfigured Outdoor		Voltage	Cabinet
Larkin Model	A0000 Models List Price (US \$)			Larkin Model	A0000 Models List Price (US \$)		
LCH0030LCBCD	39,011	208-230/3/60	C4	LCH0090LCBCD	60,683	208-230/3/60	C5
LCH0030LDBCD	41,390	460/3/60	C4	LCH0090LDBCD	63,152	460/3/60	C5
LCH0030LEBCD	42,143	575/3/60	C4	LCH0090LEBCD	64,338	575/3/60	C5
LCH0040LCBCD	42,058	208-230/3/60	C4	LCH0100LCBCD	64,974	208-230/3/60	C5
LCH0040LDBCD	44,440	460/3/60	C4	LCH0100LDBCD	66,250	460/3/60	C5
LCH0040LEBCD	45,244	575/3/60	C4	LCH0100LEBCD	67,491	575/3/60	C5
LCH0060LCBCD	43,991	208-230/3/60	C4	LCH0120LCBCD	69,556	208-230/3/60	C6
LCH0060LDBCD	46,371	460/3/60	C4	LCH0120LDBCD	71,799	460/3/60	C6
LCH0060LEBCD	47,219	575/3/60	C4	LCH0120LEBCD	74,624	575/3/60	C6
LCH0061LCBCD	46,353	208-230/3/60	C4	LCH0150LCBCD	72,481	208-230/3/60	C6
LCH0061LDBCD	48,729	460/3/60	C4	LCH0150LDBCD	77,825	460/3/60	C6
LCH0061LEBCD	49,624	575/3/60	C4	LCH0150LEBCD	80,884	575/3/60	C6
LCH0075LCBCD	53,478	208-230/3/60	C4	LCH0220LCBCD	83,801	208-230/3/60	C6
LCH0075LDBCD	55,862	460/3/60	C4	LCH0220LDBCD	84,803	460/3/60	C6
LCH0075LEBCD	56,901	575/3/60	C4	LCH0220LEBCD	88,138	575/3/60	C6

[†]Deduct \$2,717 from List Price for R404A/R507A refrigerant only if Demand Cooling is not needed

3 - 22 HP AIR-COOLED CONDENSING UNITS



PRECONFIGURED OUTDOOR MODELS

Note: Please see page HCU-6 for description of option packages.

Semi-Hermetic Medium Temperature (R-404A/ R-507A/ R-407A/ R-407C/ R-407F/ R-448A/ R-449A)

Preconfigured Outdoor		Voltage	Cabinet	Preconfigured Outdoor		Voltage	Cabinet
Larkin Model	A0000 Models List Price (US \$)			Larkin Model	A0000 Models List Price (US \$)		
LCH0056MCABX	42,235	208-230/3/60	C5	LCH0091MCABX	56,284	208-230/3/60	C6
LCH0056MDABX	44,349	460/3/60	C5	LCH0091MDABX	59,098	460/3/60	C6
LCH0056MEABX	45,236	575/3/60	C5	LCH0091MEABX	60,276	575/3/60	C6
LCH0076MCABX	47,493	208-230/3/60	C5	LCH0101MCABX	57,369	208-230/3/60	C6
LCH0076MDABX	49,866	460/3/60	C5	LCH0101MDABX	60,235	460/3/60	C6
LCH0076MEABX	50,862	575/3/60	C5	LCH0101MEABX	61,440	575/3/60	C6

Semi-Hermetic Low Temperature (R-404A/ R-507A/ R-407A R-407F/ R-448A/ R-449A)

Preconfigured Outdoor		Voltage	Cabinet	Preconfigured Outdoor		Voltage	Cabinet
Larkin Model	A0000 Models List Price (US \$)			Larkin Model	A0000 Models List Price (US \$)		
LCH0041LCBBX	42,058	208-230/3/60	C4	LCH0076LCBBX	57,393	208-230/3/60	C5
LCH0041LDBBX	43,544	460/3/60	C4	LCH0076LDBBX	59,472	460/3/60	C5
LCH0041LEBBX	44,345	575/3/60	C4	LCH0076LEBBX	60,590	575/3/60	C5
LCH0056LCBBX	43,991	208-230/3/60	C4	LCH0101LCBBX	64,974	208-230/3/60	C6
LCH0056LDBBX	45,552	460/3/60	C4	LCH0101LDBBX	67,344	460/3/60	C6
LCH0056LEBBX	46,394	575/3/60	C4	LCH0101LEBBX	68,620	575/3/60	C6
LCH0061LCBBX	54,004	208-230/3/60	C5	LCH0121LCBBX	66,240	208-230/3/60	C6
LCH0061LDBBX	55,945	460/3/60	C5	LCH0121LDBBX	68,660	460/3/60	C6
LCH0061LEBBX	56,993	575/3/60	C5	LCH0121LEBBX	69,961	575/3/60	C6
LCH0062LCBBX	55,205	208-230/3/60	C5	LCH0131LCBBX	69,019	208-230/3/60	C6
LCH0062LDBBX	57,195	460/3/60	C5	LCH0131LDBBX	71,547	460/3/60	C6
LCH0062LEBBX	58,270	575/3/60	C5	LCH0131LEBBX	72,910	575/3/60	C6



FACTORY INSTALLED: PREFERRED OPTION PACKAGES

Heatcraft now offers pre-defined kits that represent frequently ordered options or combinations of options. The preferred kits make it easier for customers to configure their units and may provide a savings over factory installed a la carte option selections.

Save money, choose a Preferred Option Package.

Option Code	Description (All Preferred options include Standard Base+)	List Adder (\$US)		
		Cabinet Sizes		
		C4	C5	C6
A0100	Defrost Timer - Air	\$ 891	\$ 891	\$ 891
A0300	Defrost Timer - Contactor	\$ 2,051	\$ 2,285	-
A0302	Defrost Timer - Contactor Low Amps	-	-	\$ 3,102
A0303	Defrost Timer - Contactor High Amps	-	-	\$ 4,464
A0400	intelliGen™/Beacon II	\$ 2,672	\$ 2,672	\$ 2,672
A1002	Replaceable Core Filter-Accumulator + Liquid Standard + Replaceable Core Filter Drier	\$ 3,541	\$ 4,778	\$ 8,215



STANDARD CONFIGURABLE MODELS

Configurable Models	
Standard Base Outdoor	Standard Base Indoor
<ul style="list-style-type: none"> • Prepainted Galvanized Cabinet • Head Pressure Control Valve • Crankcase Heater • Adjustable Low/Fixed High Pressure Control • Sealed Liquid Line Filter Drier • Liquid Line Sight Glass • Liquid Line And Suction Line Base Valves 	<ul style="list-style-type: none"> • Prepainted Galvanized Cabinet • Adjustable Low/Fixed High Pressure Control • Sealed Liquid Line Filter Drier • Liquid Line Sight Glass • Liquid Line And Suction Line Base Valves
<p>Need to customize? Look at the factory-installed options starting on page HCU-6.</p>	

Scroll Medium Temperature (R-404A/ R-507A/ R-407A/ R-407C/ R-407F/ R-448A/ R-449A)

Standard Base Outdoor		Standard Base Indoor		Voltage	Cabinet
Larkin Model	List Price (US \$)	Larkin Model	List Price (US \$)		
LCH0065MCACZA0000	39,756	LCN0065MCACZA0000	38,987	208-230/3/60	C4
LCH0065MDACZA0000	42,339	LCN0065MDACZA0000	41,569	460/3/60	C4
LCH0065MEACZA0000	43,185	LCN0065MEACZA0000	42,406	575/3/60	C4
LCH0070MCACZA0000	41,399	LCN0070MCACZA0000	40,598	208-230/3/60	C5
LCH0070MDACZA0000	44,088	LCN0070MDACZA0000	43,288	460/3/60	C5
LCH0070MEACZA0000	45,024	LCN0070MEACZA0000	44,223	575/3/60	C5
LCH0075MCACZA0000	43,332	LCN0075MCACZA0000	42,264	208-230/3/60	C5
LCH0075MDACZA0000	46,018	LCN0075MDACZA0000	44,952	460/3/60	C5
LCH0075MEACZA0000	46,935	LCN0075MEACZA0000	45,844	575/3/60	C5
LCH0086MCACZA0000	54,186	LCN0086MCACZA0000	53,063	208-230/3/60	C5
LCH0086MDACZA0000	55,479	LCN0086MDACZA0000	54,354	460/3/60	C5
LCH0086MEACZA0000	56,588	LCN0086MEACZA0000	55,439	575/3/60	C5
LCH0100MCACZA0000	56,474	LCN0100MCACZA0000	53,362	208-230/3/60	C5
LCH0100MDACZA0000	56,933	LCN0100MDACZA0000	53,824	460/3/60	C5
LCH0100MEACZA0000	58,073	LCN0100MEACZA0000	54,899	575/3/60	C5
LCH0141MCACZA0000	66,527	LCN0141MCACZA0000	63,059	208-230/3/60	C6
LCH0141MDACZA0000	69,111	LCN0141MDACZA0000	63,563	460/3/60	C6
LCH0141MEACZA0000	68,367	LCN0141MEACZA0000	64,831	575/3/60	C6



STANDARD CONFIGURABLE MODELS

Scroll Low Temperature (R-404A/ R-507A/ R-407A/ R-407C/ R-407F/ R-448A/ R-449A)

Standard Base Outdoor		Standard Base Indoor		Voltage	Cabinet
Larkin Model	List Price (US \$)	Larkin Model	List Price (US \$)		
LCH0075LCACZA0000	39,188	LCN0075LCACZA0000	38,383	208-230/3/60	C4
LCH0075LDACZA0000	41,601	LCN0075LDACZA0000	40,799	460/3/60	C4
LCH0075LEACZA0000	42,432	LCN0075LEACZA0000	41,615	575/3/60	C4
LCH0100LCBCZA0000	48,645	LCN0100LCACZA0000	47,845	208-230/3/60	C4
LCH0100LDBCZA0000	51,170	LCN0100LDACZA0000	50,367	460/3/60	C4
LCH0100LEBCZA0000	52,192	LCN0100LEACZA0000	51,372	575/3/60	C4
LCH0130LCBCZA0000	57,427	LCN0130LCACZA0000	57,941	208-230/3/60	C5
LCH0130LDBCZA0000	58,792	LCN0130LDACZA0000	59,346	460/3/60	C5
LCH0130LEBCZA0000	59,972	LCN0130LEACZA0000	60,534	575/3/60	C5
LCH0150LCBCZA0000	59,305	LCN0150LCACZA0000	59,878	208-230/3/60	C5
LCH0150LDBCZA0000	60,674	LCN0150LDACZA0000	61,282	460/3/60	C5
LCH0150LEBCZA0000	61,885	LCN0150LEACZA0000	62,506	575/3/60	C5

Discus™ Medium Temperature (R-404A/ R-507A/ R-407A/ R-407C/ R-407F/ R-448A/ R-449A)

Standard Base Outdoor		Standard Base Indoor		Voltage	Cabinet
Larkin Model	List Price (US \$)	Larkin Model	List Price (US \$)		
LCH0050MCACDA0000	38,015	LCN0050MCACDA0000	37,206	208-230/3/60	C4
LCH0050MDACDA0000	40,531	LCN0050MDACDA0000	39,721	460/3/60	C4
LCH0050MEACDA0000	41,343	LCN0050MEACDA0000	40,514	575/3/60	C4
LCH0051MCACDA0000	38,961	LCN0051MCACDA0000	38,145	208-230/3/60	C4
LCH0051MDACDA0000	41,478	LCN0051MDACDA0000	40,662	460/3/60	C4
LCH0051MEACDA0000	42,305	LCN0051MEACDA0000	41,478	575/3/60	C4
LCH0075MCACDA0000	45,434	LCN0075MCACDA0000	44,661	208-230/3/60	C4
LCH0075MDACDA0000	47,814	LCN0075MDACDA0000	47,049	460/3/60	C4
LCH0075MEACDA0000	48,775	LCN0075MEACDA0000	47,985	575/3/60	C4
LCH0076MCACDA0000	47,493	LCN0076MCACDA0000	46,424	208-230/3/60	C5
LCH0076MDACDA0000	49,965	LCN0076MDACDA0000	48,896	460/3/60	C5
LCH0076MEACDA0000	50,962	LCN0076MEACDA0000	49,875	575/3/60	C5
LCH0080MCACDA0000	55,045	LCN0080MCACDA0000	53,978	208-230/3/60	C5
LCH0080MDACDA0000	57,668	LCN0080MDACDA0000	56,597	460/3/60	C5
LCH0080MEACDA0000	58,823	LCN0080MEACDA0000	57,728	575/3/60	C5
LCH0100MCACDA0000	57,659	LCN0100MCACDA0000	56,626	208-230/3/60	C5
LCH0100MDACDA0000	61,767	LCN0100MDACDA0000	60,699	460/3/60	C5
LCH0100MEACDA0000	63,002	LCN0100MEACDA0000	61,909	575/3/60	C5
LCH0120MCACDA0000	62,424	LCN0120MCACDA0000	64,668	208-230/3/60	C5
LCH0120MDACDA0000	65,092	LCN0120MDACDA0000	67,387	460/3/60	C5
LCH0150MCACDA0000	63,940	LCN0150MCACDA0000	62,909	208-230/3/60	C6
LCH0150MDACDA0000	66,946	LCN0150MDACDA0000	65,823	460/3/60	C6
LCH0150MEACDA0000	68,286	LCN0150MEACDA0000	67,140	575/3/60	C6

3 - 22 HP AIR-COOLED CONDENSING UNITS



STANDARD CONFIGURABLE MODELS

Discus™ Low Temperature[†] (R-404A/ R-507A/ R-407A/ R-407C/ R-407F/ R-448A/ R-449A)

Standard Base Outdoor		Standard Base Indoor		Voltage	Cabinet
Larkin Model	List Price (US \$)	Larkin Model	List Price (US \$)		
LCH0030LCBCDA0000	39,011	LCN0030LCACDA0000	38,243	208-230/3/60	C4
LCH0030LDBCDA0000	41,390	LCN0030LDACDA0000	40,624	460/3/60	C4
LCH0030LEBCDA0000	42,143	LCN0030LEACDA0000	41,360	575/3/60	C4
LCH0040LCBCDA0000	42,058	LCN0040LCACDA0000	41,289	208-230/3/60	C4
LCH0040LDBCDA0000	44,440	LCN0040LDACDA0000	43,666	460/3/60	C4
LCH0040LEBCDA0000	45,244	LCN0040LEACDA0000	44,460	575/3/60	C4
LCH0060LCBCDA0000	43,991	LCN0060LCACDA0000	43,220	208-230/3/60	C4
LCH0060LDBCDA0000	46,371	LCN0060LDACDA0000	45,603	460/3/60	C4
LCH0060LEBCDA0000	47,219	LCN0060LEACDA0000	46,433	575/3/60	C4
LCH0061LCBCDA0000	46,353	LCN0061LCACDA0000	45,580	208-230/3/60	C4
LCH0061LDBCDA0000	48,729	LCN0061LDACDA0000	47,962	460/3/60	C4
LCH0061LEBCDA0000	49,624	LCN0061LEACDA0000	48,838	575/3/60	C4
LCH0075LCBCDA0000	53,478	LCN0075LCACDA0000	52,707	208-230/3/60	C4
LCH0075LDBCDA0000	55,862	LCN0075LDACDA0000	55,090	460/3/60	C4
LCH0075LEBCDA0000	56,901	LCN0075LEACDA0000	56,109	575/3/60	C4
LCH0090LCBCDA0000	60,683	LCN0090LCACDA0000	59,618	208-230/3/60	C5
LCH0090LDBCDA0000	63,152	LCN0090LDACDA0000	62,084	460/3/60	C5
LCH0090LEBCDA0000	64,338	LCN0090LEACDA0000	63,249	575/3/60	C5
LCH0100LCBCDA0000	64,974	LCN0100LCACDA0000	63,904	208-230/3/60	C5
LCH0100LDBCDA0000	66,250	LCN0100LDACDA0000	65,178	460/3/60	C5
LCH0100LEBCDA0000	67,491	LCN0100LEACDA0000	66,400	575/3/60	C5
LCH0120LCBCDA0000	69,556	LCN0120LCACDA0000	68,372	208-230/3/60	C6
LCH0120LDBCDA0000	71,799	LCN0120LDACDA0000	70,615	460/3/60	C6
LCH0120LEBCDA0000	74,624	-	-	575/3/60	C6
LCH0150LCBCDA0000	72,481	LCN0150LCACDA0000	71,299	460/3/60	C6
LCH0150LDBCDA0000	77,825	LCN0150LDACDA0000	76,639	208-230/3/60	C6
LCH0150LEBCDA0000	80,884	-	-	575/3/60	C6
LCH0220LCBCDA0000	83,801	LCN0220LCACDA0000	82,624	460/3/60	C6
LCH0220LDBCDA0000	84,803	LCN0220LDACDA0000	84,347	208-230/3/60	C6
LCH0220LEBCDA0000	88,138	-	-	575/3/60	C6

[†]Deduct \$2,717 from List Price for R404A/R507A refrigerant only if Demand Cooling is not needed



STANDARD CONFIGURABLE MODELS

Bitzer Semi-Hermetic Medium Temperature (R-404A/ R-507A/ R-407A/ R-407C/ R-407F/ R-448A/ R-449A)

Standard Base Outdoor		Standard Base Indoor		Voltage	Cabinet
Larkin Model	List Price (US \$)	Larkin Model	List Price (US \$)		
LCH0056MCABXA0000	42,235	LCN0056MCABXA0000	41,436	208-230/3/60	C5
LCH0056MDABXA0000	44,349	LCN0056MDABXA0000	43,505	460/3/60	C5
LCH0056MEABXA0000	45,236	LCN0056MEABXA0000	44,374	575/3/60	C5
LCH0076MCABXA0000	47,493	LCN0076MCABXA0000	46,588	208-230/3/60	C5
LCH0076MDABXA0000	49,866	LCN0076MDABXA0000	48,921	460/3/60	C5
LCH0076MEABXA0000	50,862	LCN0076MEABXA0000	49,894	575/3/60	C5
LCH0091MCABXA0000	56,284	LCN0091MCABXA0000	55,212	208-230/3/60	C6
LCH0091MDABXA0000	59,098	LCN0091MDABXA0000	57,975	460/3/60	C6
LCH0091MEABXA0000	60,276	LCN0091MEABXA0000	59,132	575/3/60	C6
LCH0101MCABXA0000	57,369	LCN0101MCABXA0000	56,279	208-230/3/60	C6
LCH0101MDABXA0000	60,235	LCN0101MDABXA0000	59,091	460/3/60	C6
LCH0101MEABXA0000	61,440	LCN0101MEABXA0000	60,274	575/3/60	C6

Bitzer Semi-Hermetic Low Temperature (R-404A/ R-507A/ R-407A/ R-407F/ R-448A/ R-449A)

Standard Base Outdoor		Standard Base Indoor		Voltage	Cabinet
Larkin Model	List Price (US \$)	Larkin Model	List Price (US \$)		
LCH0041LCBBXA0000	42,058	LCN0041LCABXA0000	41,374	208-230/3/60	C4
LCH0041LDBBXA0000	43,544	LCN0041LDABXA0000	42,834	460/3/60	C4
LCH0041LEBBXA0000	44,345	LCN0041LEABXA0000	43,618	575/3/60	C4
LCH0056LCBBXA0000	43,991	LCN0056LCABXA0000	43,273	208-230/3/60	C4
LCH0056LDBBXA0000	45,552	LCN0056LDABXA0000	44,800	460/3/60	C4
LCH0056LEBBXA0000	46,394	LCN0056LEABXA0000	45,627	575/3/60	C4
LCH0061LCBBXA0000	54,004	LCN0061LCABXA0000	53,105	208-230/3/60	C5
LCH0061LDBBXA0000	55,945	LCN0061LDABXA0000	55,013	460/3/60	C5
LCH0061LEBBXA0000	56,993	LCN0061LEABXA0000	56,044	575/3/60	C5
LCH0062LCBBXA0000	55,205	LCN0062LCABXA0000	54,287	208-230/3/60	C5
LCH0062LDBBXA0000	57,195	LCN0062LDABXA0000	56,243	460/3/60	C5
LCH0062LEBBXA0000	58,270	LCN0062LEABXA0000	57,294	575/3/60	C5
LCH0076LCBBXA0000	57,393	LCN0076LCABXA0000	56,437	208-230/3/60	C5
LCH0076LDBBXA0000	59,472	LCN0076LDABXA0000	58,472	460/3/60	C5
LCH0076LEBBXA0000	60,590	LCN0076LEABXA0000	59,573	575/3/60	C5
LCH0101LCBBXA0000	64,974	LCN0101LCABXA0000	63,876	208-230/3/60	C6
LCH0101LDBBXA0000	67,344	LCN0101LDABXA0000	66,207	460/3/60	C6
LCH0101LEBBXA0000	68,620	LCN0101LEABXA0000	67,463	575/3/60	C6
LCH0121LCBBXA0000	66,240	LCN0121LCABXA0000	65,118	208-230/3/60	C6
LCH0121LDBBXA0000	68,660	LCN0121LDABXA0000	67,498	460/3/60	C6
LCH0121LEBBXA0000	69,961	LCN0121LEABXA0000	68,778	575/3/60	C6
LCH0131LCBBXA0000	69,019	LCN0131LCABXA0000	67,849	208-230/3/60	C6
LCH0131LDBBXA0000	71,547	LCN0131LDABXA0000	70,331	460/3/60	C6
LCH0131LEBBXA0000	72,910	LCN0131LEABXA0000	71,674	575/3/60	C6

3 - 22 HP AIR-COOLED CONDENSING UNITS



FACTORY INSTALLED: A LA CARTE OPTIONS

Electrical Options

Option Code	Description	C4	C5	C6	Notes
DFT.AIR TIMER	Defrost Timer - Air	\$ 938	\$ 938	\$ 938	–
SW.ADJ LOW_ADJ HI_MAN	Adjustable high pressure switch w/ manual reset & adjustable low pressure switch	\$ 661	\$ 661	–	–
SW.DUAL PRESSURE CONTROL	Dual pressure control with adjustable high & low pressure settings	\$ 259	\$ 259	\$ 259	–
FSD.AIR FUSED DISCONNECT	Mounted fused disconnect	–	–	\$ 5,088	–
PLM.PLM	Phase Loss Monitor	\$ 1,925	\$ 1,925	\$ 1,925	–
FCY.ADJ PRESSURE	Fan Cycling - Temperature & Pressure	–	–	\$ 924	Not available for C6 Discus Low Temp.
ELC.EBOX_CIR BRS	Circuit Breakers (Compressor, Control & Fan) 230V	–	–	\$ 6,083	–
ELC.EBOX_CIR BRS	Circuit Breakers (Compressor, Control & Fan) 460V	–	–	\$ 6,083	–
CFS.COMPRESSOR FUSES	Compressor Fusing	–	–	\$ 691	–
ELC.EBOX_NEMA CONT	NEMA Contactors 230V	–	–	\$ 3,663	–
ELC.EBOX_NEMA CONT	NEMA Contactors 460V	–	–	\$ 3,663	–
DFT.ELEC TIMER_CONT	Electric Defrost Kit	\$ 2,159	\$ 2,405	–	Includes (1) electric defrost timer, (1 or 2) heater & (1) fan contactors, terminal strip
DFT.ELEC TIMER_CONT_LOW	Electric Defrost Kit (Low Amps)	–	–	\$ 3,265	Includes (1) electric defrost timer, (1 or 2) heater & (1) fan contactors, terminal strip
DFT.ELEC TIMER_CONT_HIGH	Electric Defrost Kit (High Amps)	–	–	\$ 4,699	Includes (1) electric defrost timer, (1 or 2) heater & (1) fan contactors, terminal strip
DEF.FUSE OPTION ONLY	Fuses for electric defrost kits	\$ 767	\$ 767	–	–
DEF.EVAP FUSING_LOW AMPS	Fuses for electric defrost kits (Low Amps)	–	–	\$ 767	–
DEF.EVAP FUSING_HIGH AMPS	Fuses for electric defrost kits (High Amps)	–	–	\$ 767	–
EHR.TIMER_CONT_LOW_HO_REL	Evaporator hold out relay	–	–	\$ 382	–
SDK.TIMER_SDK_4 CONT_HIGH	InterLink™ Smart Defrost Kit™	\$ 1,453	\$ 1,453	\$ 1,453	Can not be used alone. Must also select a electric defrost timer or electric defrost kit.



FACTORY INSTALLED: A LA CARTE OPTIONS

Mechanical Options

Option Code	Description	C4	C5	C6	Notes
CS.PRO RTPF COIL	BohnGuard™ condenser fin protection	\$ 2,074	\$ 2,865	\$ 4,024	–
CS.CPR RTPF COIL	Copper condenser fins	\$ 7,505	\$ 8,614	\$ 11,265	–
CS.ELC RTPF COIL	ElectroFin coil coating	Call Factory			–
CS.BRZ RTPF COIL	Bronz-Glow coil coating	Call Factory			–
LIQ.FILTER_SG_RCFD	Replaceable core liquid-line filter drier & sight glass	\$ 793	\$ 793	\$ 793	–
LIQ.FILTER_SG_SV	Liquid-line solenoid valve	\$ 1,039	\$ 1,166	\$ 1,598	Not recommended on applications with line runs more than 25 feet.
SUC.FILTER	Suction-line filter	\$ 794	\$ 1,349	\$ 2,156	–
SUC.FILTER_RC	Replaceable core suction-line filter	\$ 1,526	\$ 2,084	\$ 2,821	–
SUC.ACCUMULATOR	Suction accumulator	\$ 1,222	\$ 1,901	\$ 4,601	–
DIS.OIL SEPARATOR	Oil separator with discharge line check valve	\$ 2,209	\$ 2,334	\$ 2,762	–
DIS.ADJ HPV	Adjustable Head Pressure Valve	\$ 940	\$ 1,296	–	–
DIS.OIL SEPARATOR_ADJ HPV	Oil Separator, Adjustable Head Pressure Valve	\$ 3,097	\$ 3,397	–	–
UNL.COMP UNLOADING	Compressor Unloading (One Step)	\$ 3,812	\$ 3,812	\$ 3,812	–
REC.OVS RECEIVER	Oversized receiver	\$ 641	\$ 1,036	\$ 2,082	See technical bulletin for volumes
LOW.STD RECEIVER_LOW AMB	Standard receiver with low ambient kit (heated/insulated receiver & low pressure bypass time delay relay)	\$ 1,334	\$ 1,334	\$ 1,785	–

Defrost Options

Option Code	Description	C4	C5	C6
DFT.INTELLIGEN_BEACON	intelliGen™/Beacon II	\$ 2,813	\$ 2,813	\$ 2,813

3 - 22 HP AIR-COOLED CONDENSING UNITS



SHIPPED-LOOSE ACCESSORIES

A wide range of shipped-loose accessories are available to order. Can't Find Something? Other options and accessories might be available on a custom order basis. Please contact your local Sales Representative or Account Engineer for assistance.

Option Code	Description	List Price (\$US)	Notes
50053301	8" Extended Legs	\$ 746	Applicable for C4, C5 Cabinets
59894901	12" Extended Legs	\$ 865	Applicable for C6 Cabinet
59898801	Hail Guards	\$ 797	Applicable for C4 Cabinet
59898901	Hail Guards	\$ 899	Applicable for C5 Cabinet
59896801	Hail Guards	\$ 1008	Applicable for C6 Cabinet

Crankcase Pressure Regulator (CPR) Valves

A selection program must be used to pick the proper valve. The selection program requires the following inputs: system capacity, suction temperature, and maximum holding temperature. Not available for use on Beacon II™ Outdoor units. Should not be used with MOP type expansion valves in unit coolers. Please contact your local Sales Representative or Account Engineer for assistance.

Size	Part Number	List Price (\$US)
5/8"	2930142	\$ 522
7/8"	29346101	\$ 715
1 1/8"	29399012	\$ 1053
1 3/8"	29394306	\$ 4,009
1 5/8"	4262Q	\$5,626

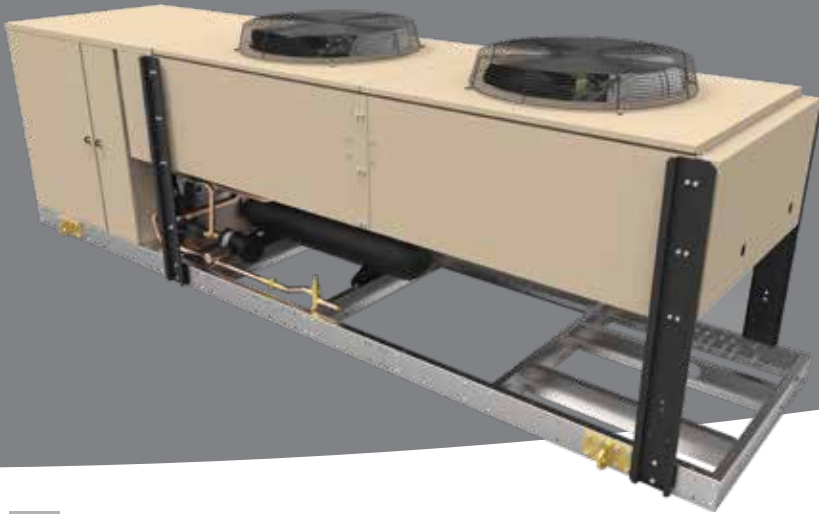

12 - 50 HP VERTICAL AIR-COOLED CONDENSING UNITS

NOMENCLATURE

<p>BRAND L = Larkin</p>	<p>CONDENSING UNIT STYLE V = Outdoor Vertical M = Mohave D = Outdoor Dual Vertical</p>	<p>TEMP RANGE L = Low Temperature M = Medium Temperature</p>	<p>REVISION</p>	<p>COMPRESSOR STYLE D = Discus™ X = Bitzer Semi-Hermetic</p>					
L	C	V	0300	M	C	A	C	D	A0000
<p>PRODUCT IDENTIFIER C = Condensing Unit</p>	<p>HP 0062 = 6 hp 0077 = 7.5 hp 0078 = 7.5 hp 0082 = 8 hp 0092 = 9 hp 0102 = 10 hp 0120/0122 = 12 hp 0130 = 13 hp 0150/0151/0152 = 15 hp 0200/0201/0202 = 20 hp 0220/0222 = 22 hp 0240 = 24 hp 0250/0251/0252 = 25 hp 0260 = 26 hp 0270/0272 = 27 hp 0300/0301/0302 = 30 hp 0330 = 33 hp 0350/0351/0352 = 35 hp 0400/0401/0402 = 40 hp 0440 = 44 hp 0500 = 50 hp 0520 = 52 hp 0540 = 54 hp 0600 = 60 hp 0660 = 66 hp 0700 = 70 hp 0800 = 80 hp 1100 = 100 hp</p>		<p>VOLTAGE C = 208-230/3/60 D = 460/3/60 K = 230/3/60 E = 575/3/60</p>	<p>COMPRESSOR MANUFACTURER C = Copeland B = Bitzer</p>	<p>FACTORY INSTALLED OPTION PACKAGES A#### = Preferred Option Packages C#### = A la Carte Options X#### = Custom Option Packages</p>				

STANDARD FEATURES

- Aluminum Fin Coil
- Adjustable Head Pressure Control (150 psi for Medium Temp. and 100 psi for Low Temp.)
- Sealed Liquid Line Filter Drier (Liquid Standard)
- Liquid Line Sight Glass (Liquid Standard)
- High Pressure Switch-Auto reset
- Low Pressure Switch



12 - 50 HP VERTICAL AIR-COOLED CONDENSING UNITS

FEATURES & BENEFITS

QUALITY

- All joints are sweat type connections, no mechanical joints to leak
- Fixed high and adjustable low pressure switch
- Piping is laid out to minimize stress and vibration and is pre-bent to eliminate braze joints where possible to reduce leak potential
- Pressure relief valve on receiver
- Refrigeration duty, rifled copper condenser tubing
- Separate subcooling circuit in condenser for added capacity and vapor free liquid
- Servicemate diagnostic module standard on all non-beacon condensing units
- Sight glass is easily viewable

SERVICEABILITY

- Convenient access panels to easily service internal components
- Large electrical panel to facilitate ease of access
- Manual pumpdown switch on all units
- Lighted e-box with battery back-up

- Hinged venturi fan panels for easy access
- E-box door props

COMPONENTS

- Receivers are sized for sufficient pumpdown capacity with inlet and outlet service valves
- Spring-mounted compressors with suction and discharge eliminators
- High efficiency motors
- High pressure switch-auto reset
- Adjustable head pressure control
- Aluminum fin coil
- Sealed liquid line filter drier (lqd. Std.)
- Liquid line sight glass (lqd. Std.)

CABINET AND CONSTRUCTION

- All units feature the floating tube coil which eliminates tube sheet leaks
- Painted steel cabinet for superior strength and corrosion resistance
- Clevis hook-up brackets to aid unit installation

OUTSTANDING FEATURES

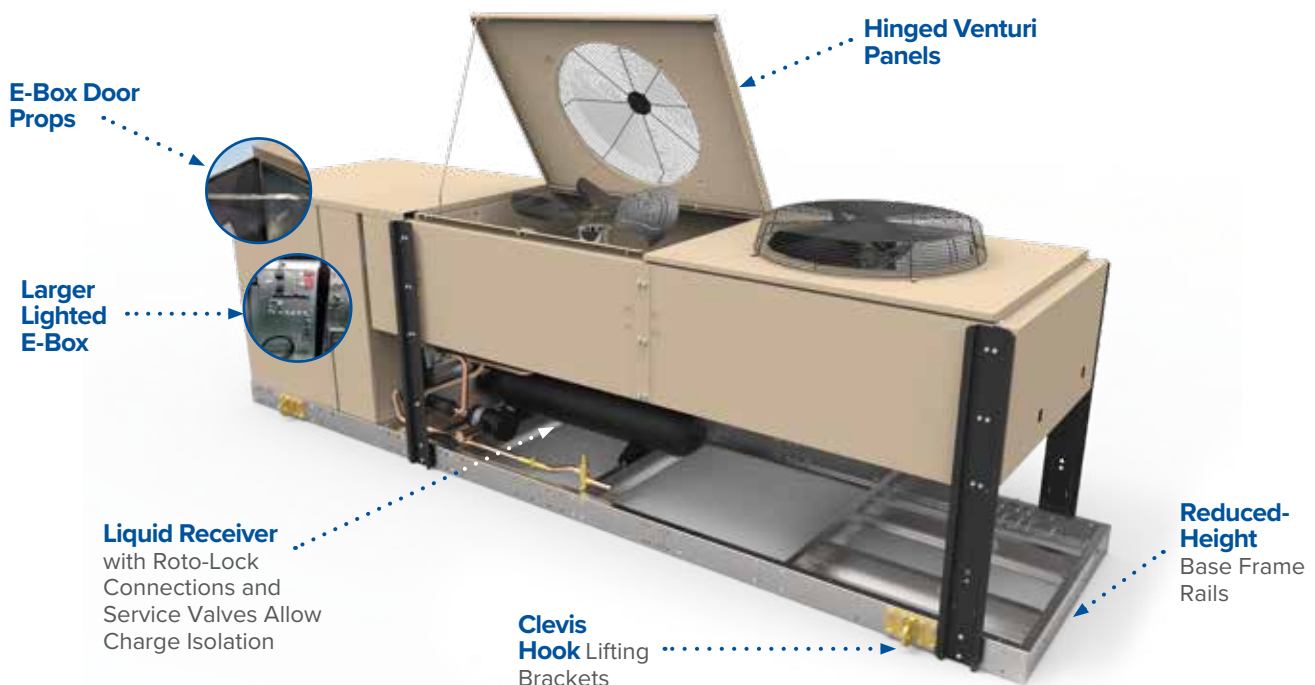

12 - 50 HP VERTICAL AIR-COOLED CONDENSING UNITS



PRECONFIGURED OUTDOOR MODELS

See page VCU-5 for description of Factory Installed: Preferred Option Packages

Copeland Discus™ Medium Temperature (R-404A/ R-507A/ R-407A/ R-407C/ R-407F/ R-448A/ R-449A)

Preconfigured Outdoor			Preconfigured Outdoor		
Larkin Model	A0000 Models List Price (US \$)	Voltage	Larkin Model	A0000 Models List Price (US \$)	Voltage
LCV0150MCACD	\$70,554	208-230/3/60	LCV0300MCACD	\$109,864	208-230/3/60
LCV0150MDACD	\$71,949	460/3/60	LCV0300MDACD	\$111,260	460/3/60
LCV0150MEACD	\$73,386	575/3/60	LCV0300MEACD	\$113,485	575/3/60
LCV0151MCACD	\$75,942	208-230/3/60	LCV0301MCACD	\$117,737	208-230/3/60
LCV0151MDACD	\$77,300	460/3/60	LCV0301MDACD	\$119,098	460/3/60
LCV0151MEACD	\$78,849	575/3/60	LCV0301MEACD	\$121,479	575/3/60
LCV0200MCACD	\$78,511	208-230/3/60	LCV0350MCACD	\$124,357	208-230/3/60
LCV0200MDACD	\$79,905	460/3/60	LCV0350MDACD	\$125,502	460/3/60
LCV0200MEACD	\$81,502	575/3/60	LCV0350MEACD	\$128,019	575/3/60
LCV0201MCACD	\$80,060	208-230/3/60	LCV0351MCACD	\$147,219	208-230/3/60
LCV0201MDACD	\$81,420	460/3/60	LCV0351MDACD	\$148,575	460/3/60
LCV0201MEACD	\$83,054	575/3/60	LCV0351MEACD	\$151,548	575/3/60
LCV0250MCACD	\$93,675	208-230/3/60	LCV0400MDACD	\$139,074	460/3/60
LCV0250MDACD	\$95,067	460/3/60	LCV0400MEACD	\$141,852	575/3/60
LCV0250MEACD	\$96,966	575/3/60	LCV0400MKACD	\$137,201	230/3/60
LCV0251MCACD	\$112,818	208-230/3/60	LCV0401MKACD	\$148,839	230/3/60
LCV0251MDACD	\$114,302	460/3/60	LCV0401MDACD	\$150,226	460/3/60
LCV0251MEACD	\$116,585	575/3/60	LCV0401MEACD	\$153,227	575/3/60
LCV0260MCACD	\$102,391	208-230/3/60	LCV0500MDACD	\$167,772	460/3/60
LCV0260MDACD	\$103,745	460/3/60	LCV0500MEACD	\$177,634	575/3/60
LCV0260MEACD	\$105,823	575/3/60			

Copeland Discus™ Low Temperature (R-404A/ R-507A/ R-407A/ R-407C/ R-407F/ R-448A/ R-449A)

Preconfigured Outdoor			Preconfigured Outdoor		
Larkin Model	A0000 Models List Price (US \$)	Voltage	Larkin Model	A0000 Models List Price (US \$)	Voltage
Copeland Discus™ Low Temperature (R-404A/ R-507A/ R-407A/ R-407C/ R-407F/ R-448A/ R-449A)					
LCV0120LCACD	\$76,529	208-230/3/60	LCV0270LCACD	\$103,489	208-230/3/60
LCV0120LDACD	\$77,933	460/3/60	LCV0270LDACD	\$104,847	460/3/60
LCV0120LEACD	\$79,403	575/3/60	LCV0270LEACD	\$106,859	575/3/60
LCV0150LCACD	\$79,916	208-230/3/60	LCV0300LCACD	\$114,385	208-230/3/60
LCV0150LDACD	\$81,310	460/3/60	LCV0300LDACD	\$115,739	460/3/60
LCV0150LEACD	\$82,856	575/3/60	LCV0300LEACD	\$117,973	575/3/60
LCV0220LCACD	\$90,570	208-230/3/60	LCV0400LDACD	\$143,578	460/3/60
LCV0220LDACD	\$91,929	460/3/60	LCV0400LEACD	\$152,420	575/3/60
LCV0220LEACD	\$93,684	575/3/60			



12 - 50 HP VERTICAL AIR-COOLED CONDENSING UNITS

PRECONFIGURED OUTDOOR VCU MODELS

See page VCU-5 for description of Factory Installed: Preferred Option Packages

Bitzer Semi-Hermetic Medium Temperature (R-404A/ R-507A/ R-407A/ R-407C/ R-407F/ R-448A/ R-449A)

Preconfigured Outdoor			Preconfigured Outdoor		
Larkin Model	A0000 Models List Price (US \$)	Voltage	Larkin Model	A0000 Models List Price (US \$)	Voltage
LCV0150MCABX	\$70,554	208-230/3/60	LCV0300MEABX	\$111,504	575/3/60
LCV0150MDABX	\$71,399	460/3/60	LCV0330MCABX	\$121,026	208-230/3/60
LCV0150MEABX	\$72,811	575/3/60	LCV0330MDABX	\$122,477	460/3/60
LCV0200MCABX	\$80,060	208-230/3/60	LCV0330MEABX	\$124,904	575/3/60
LCV0200MDABX	\$81,020	460/3/60	LCV0350MCABX	\$135,347	208-230/3/60
LCV0200MEABX	\$82,621	575/3/60	LCV0350MDABX	\$136,969	460/3/60
LCV0220MCABX	\$91,166	208-230/3/60	LCV0350MEABX	\$139,677	575/3/60
LCV0220MDABX	\$92,261	460/3/60	LCV0400MCABX	\$148,849	208-230/3/60
LCV0220MEABX	\$94,081	575/3/60	LCV0400MDABX	\$150,641	460/3/60
LCV0250MCABX	\$102,391	208-230/3/60	LCV0400MEABX	\$153,614	575/3/60
LCV0250MDABX	\$103,620	460/3/60	LCV0500MCABX	\$171,196	208-230/3/60
LCV0250MEABX	\$105,668	575/3/60	LCV0500MDABX	\$173,253	460/3/60
LCV0300MCABX	\$108,048	208-230/3/60	LCV0500MEABX	\$176,676	575/3/60
LCV0300MDABX	\$109,344	460/3/60			

Bitzer Semi-Hermetic Low Temperature (R-404A/ R-507A/ R-407A/ R-407C/ R-407F/ R-448A/ R-449A)

Preconfigured Outdoor			Preconfigured Outdoor		
Larkin Model	A0000 Models List Price (US \$)	Voltage	Larkin Model	A0000 Models List Price (US \$)	Voltage
LCV0130LCABX	\$72,970	208-230/3/60	LCV0250LCABX	\$110,511	208-230/3/60
LCV0130LDABX	\$73,989	460/3/60	LCV0250LDABX	\$112,060	460/3/60
LCV0130LEABX	\$75,451	575/3/60	LCV0250LEABX	\$114,270	575/3/60
LCV0150LCABX	\$81,136	208-230/3/60	LCV0300LCABX	\$116,651	208-230/3/60
LCV0150LDABX	\$82,273	460/3/60	LCV0300LDABX	\$118,280	460/3/60
LCV0150LEABX	\$83,898	575/3/60	LCV0300LEABX	\$120,613	575/3/60
LCV0200LCABX	\$94,458	208-230/3/60	LCV0400LCABX	\$135,347	208-230/3/60
LCV0200LDABX	\$95,781	460/3/60	LCV0400LDABX	\$141,015	460/3/60
LCV0200LEABX	\$97,669	575/3/60	LCV0400LEABX	\$143,797	575/3/60
LCV0220LCABX	\$99,604	208-230/3/60			
LCV0220LDABX	\$100,995	460/3/60			
LCV0220LEABX	\$102,988	575/3/60			



12 - 50 HP VERTICAL AIR-COOLED CONDENSING UNITS

FACTORY INSTALLED: PREFERRED OPTION PACKAGES

Heatcraft now offers pre-defined kits that represent frequently ordered options or combinations of options. The preferred kits make it easier for customers to configure their units and may provide a savings over factory installed a la carte option selections.

Save money, choose a Preferred Option Package.

Option Code	Description (All Preferred options include Standard Base+)	Models Used On	Price
A0100	Defrost Timer - Air	All VCU's	\$891
A1002	Lqd Std. Replacable core filter-drier + Replacable core Suction line filter+Accumulator	0120-0200	\$8,211
A1002	Lqd Std. Replacable core filter-drier + Replacable core Suction line filter+Accumulator	0220-0400	\$9,391
A1002	Lqd Std. Replacable core filter-drier + Replacable core Suction line filter+Accumulator	500	\$11,938
A1003	Replacable core Suction-line filter + Accumulator	0120-0200	\$7,047
A1003	Replacable core Suction-line filter + Accumulator	0220-0400	\$7,814
A1003	Replacable core Suction-line filter + Accumulator	500	\$10,013
A1004	Pr. Controlled fan cycling + Replacable core Suction-line filter + Accumulator	0120-0300 Standard Models 0151-0201 High Eff. Models 0130-0250 Bitzer Models	\$9,878
A1004	Pr. Controlled fan cycling + Replacable core Suction-line filter + Accumulator	0350-0400 Standard Models 0251-0301 High Eff. Models 0300-0350 Bitzer Models	\$11,185
A1004	Pr. Controlled fan cycling + Replacable core Suction-line filter + Accumulator	0351-0401 High Eff. Models	\$11,659
A1004	Pr. Controlled fan cycling + Replacable core Suction-line filter + Accumulator	0400-0500 Bitzer Models	\$13,858
A1300	Oil Separator with discharge line check valve	0120-0330 Standard Models	\$2,623
A1300	Oil Separator with discharge line check valve	0350-0401 Standard Models	\$4,430
A1300	Oil Separator with discharge line check valve	500	\$5,318
A1400	Phase loss monitor	0120-0500 All Models	\$1,829
A0400	Beacon II/intelliGen™	0150M-0300M Standard Models 0151M-0201M High Efficiency Models 0150M-0250M Bitzer Models 0120L-0300L Standard Models 0130L-0300L Bitzer Models	\$4,806
A0400	Beacon II/intelliGen™	0350M-0400M Standard Models 0251M-0401M High Efficiency Models 0300M-0350M Bitzer Models 0400L Bitzer Models	\$5,591
A0400	Beacon II/intelliGen™	0400M-0500M Bitzer Models	\$7,016

12 - 50 HP VERTICAL AIR-COOLED CONDENSING UNITS



STANDARD CONFIGURABLE OUTDOOR MODELS

Copeland Discus™ Medium Temperature (R-404A/ R-507A/ R-407A/ R-407C/ R-407F/ R-448A/ R-449A)

Standard Base Outdoor					
Larkin Model	List Price (US \$)	Voltage	Larkin Model	List Price (US \$)	Voltage
LCV0150MCACD	\$70,554	208-230/3/60	LCV0300MCACD	\$109,864	208-230/3/60
LCV0150MDACD	\$71,949	460/3/60	LCV0300MDACD	\$111,260	460/3/60
LCV0150MEACD	\$73,386	575/3/60	LCV0300MEACD	\$113,485	575/3/60
LCV0151MCACD	\$75,942	208-230/3/60	LCV0301MCACD	\$117,737	208-230/3/60
LCV0151MDACD	\$77,300	460/3/60	LCV0301MDACD	\$119,098	460/3/60
LCV0151MEACD	\$78,849	575/3/60	LCV0301MEACD	\$121,479	575/3/60
LCV0200MCACD	\$78,511	208-230/3/60	LCV0350MCACD	\$124,357	208-230/3/60
LCV0200MDACD	\$79,905	460/3/60	LCV0350MDACD	\$125,502	460/3/60
LCV0200MEACD	\$81,502	575/3/60	LCV0350MEACD	\$128,019	575/3/60
LCV0201MCACD	\$80,060	208-230/3/60	LCV0351MCACD	\$147,219	208-230/3/60
LCV0201MDACD	\$81,420	460/3/60	LCV0351MDACD	\$148,575	460/3/60
LCV0201MEACD	\$83,054	575/3/60	LCV0351MEACD	\$151,548	575/3/60
LCV0250MCACD	\$93,675	208-230/3/60	LCV0400MDACD	\$139,074	460/3/60
LCV0250MDACD	\$95,067	460/3/60	LCV0400MEACD	\$141,852	575/3/60
LCV0250MEACD	\$96,966	575/3/60	LCV0400MKACD	\$137,201	230/3/60
LCV0251MCACD	\$112,818	208-230/3/60	LCV0401MDACD	\$150,226	460/3/60
LCV0251MDACD	\$114,302	460/3/60	LCV0401MEACD	\$153,227	575/3/60
LCV0251MEACD	\$116,585	575/3/60	LCV0401MKACD	\$148,839	230/3/60
LCV0260MCACD	\$102,391	208-230/3/60	LCV0500MDACD	\$167,772	460/3/60
LCV0260MDACD	\$103,745	460/3/60	LCV0500MEACD	\$177,634	575/3/60
LCV0260MEACD	\$105,823	575/3/60			

Copeland Discus™ Low Temperature (R-404A/ R-507A/ R-407A/ R-407C/ R-407F/ R-448A/ R-449A)

Standard Base Outdoor					
Larkin Model	List Price (US \$)	Voltage	Larkin Model	List Price (US \$)	Voltage
LCV0120LCACD	\$76,529	208-230/3/60	LCV0270LCACD	\$103,489	208-230/3/60
LCV0120LDACD	\$77,933	460/3/60	LCV0270LDACD	\$104,847	460/3/60
LCV0120LEACD	\$79,403	575/3/60	LCV0270LEACD	\$106,859	575/3/60
LCV0150LCACD	\$79,916	208-230/3/60	LCV0300LCACD	\$114,385	208-230/3/60
LCV0150LDACD	\$81,310	460/3/60	LCV0300LDACD	\$115,739	460/3/60
LCV0150LEACD	\$82,856	575/3/60	LCV0300LEACD	\$117,973	575/3/60
LCV0220LCACD	\$90,570	208-230/3/60	LCV0400LDACD	\$143,578	460/3/60
LCV0220LDACD	\$91,929	460/3/60	LCV0400LEACD	\$152,420	575/3/60
LCV0220LEACD	\$93,684	575/3/60			



12 - 50 HP VERTICAL AIR-COOLED CONDENSING UNITS

STANDARD CONFIGURABLE OUTDOOR MODELS

Bitzer Semi-Hermetic Medium Temperature (R-404A/ R-507A/ R-407A/ R-407C/ R-407F/ R-448A/ R-449A)

Standard Base Outdoor					
Larkin Model	List Price (US \$)	Voltage	Larkin Model	List Price (US \$)	Voltage
LCV0150MCABX	\$70,554	208-230/3/60	LCV0330MCABX	\$121,026	208-230/3/60
LCV0150MDABX	\$71,399	460/3/60	LCV0330MDABX	\$122,477	460/3/60
LCV0150MEABX	\$72,811	575/3/60	LCV0330MEABX	\$124,904	575/3/60
LCV0200MCABX	\$80,060	208-230/3/60	LCV0350MCABX	\$135,347	208-230/3/60
LCV0200MDABX	\$81,020	460/3/60	LCV0350MDABX	\$136,969	460/3/60
LCV0200MEABX	\$82,621	575/3/60	LCV0350MEABX	\$139,677	575/3/60
LCV0220MCABX	\$91,166	208-230/3/60	LCV0350MCABX	\$135,347	208-230/3/60
LCV0220MDABX	\$92,261	460/3/60	LCV0350MDABX	\$136,969	460/3/60
LCV0220MEABX	\$94,081	575/3/60	LCV0350MEABX	\$139,677	575/3/60
LCV0250MCABX	\$102,391	208-230/3/60	LCV0400MCABX	\$148,849	208-230/3/60
LCV0250MDABX	\$103,620	460/3/60	LCV0400MDABX	\$150,641	460/3/60
LCV0250MEABX	\$105,668	575/3/60	LCV0400MEABX	\$153,614	575/3/60
LCV0300MCABX	\$108,048	208-230/3/60	LCV0500MCABX	\$171,196	208-230/3/60
LCV0300MDABX	\$109,344	460/3/60	LCV0500MDABX	\$173,253	460/3/60
LCV0300MEABX	\$111,504	575/3/60	LCV0500MEABX	\$176,676	575/3/60

Bitzer Semi-Hermetic Low Temperature (R-404A/ R-507A/ R-407A/ R-407C/ R-407F/ R-448A/ R-449A)

Standard Base Outdoor					
Larkin Model	List Price (US \$)	Voltage	Larkin Model	List Price (US \$)	Voltage
LCV0130LCABX	\$72,970	208-230/3/60	LCV0250LCABX	\$110,511	208-230/3/60
LCV0130LDABX	\$73,989	460/3/60	LCV0250LDABX	\$112,060	460/3/60
LCV0130LEABX	\$75,451	575/3/60	LCV0250LEABX	\$114,270	575/3/60
LCV0150LCABX	\$81,136	208-230/3/60	LCV0300LCABX	\$116,651	208-230/3/60
LCV0150LDABX	\$82,273	460/3/60	LCV0300LDABX	\$118,280	460/3/60
LCV0150LEABX	\$83,898	575/3/60	LCV0300LEABX	\$120,613	575/3/60
LCV0200LCABX	\$94,458	208-230/3/60	LCV0400LCABX	\$135,347	208-230/3/60
LCV0200LDABX	\$95,781	460/3/60	LCV0400LDABX	\$141,015	460/3/60
LCV0200LEABX	\$97,669	575/3/60	LCV0400LEABX	\$143,797	575/3/60
LCV0220LCABX	\$99,604	208-230/3/60			
LCV0220LDABX	\$100,995	460/3/60			
LCV0220LEABX	\$102,988	575/3/60			

12 - 50 HP VERTICAL AIR-COOLED CONDENSING UNITS



FACTORY INSTALLED: A LA CARTE OPTIONS

Electrical Options

Option Code	Description	Models Used On	Notes	Price
FCY.ADJ TEMP-1	Adjustable Temperature	0120-0300 Standard Models-Copeland 0151-0201 High Efficiency Models 0130-0250 Standard Models-Bitzer	Fan closest to the header is not cycled.	\$2,980
FCY.ADJ TEMP-2	Adjustable Temperature	0350-0400 Standard Models 0251-0301 High Efficiency Models 0300-0350 Standard Models-Bitzer	Fan closest to the header is not cycled.	\$3,548
FCY.ADJ TEMP-3	Adjustable Temperature	0351-0401 High Efficiency Models 0400-0500 Standard Models-Bitzer	Fan closest to the header is not cycled.	\$4,047
FCY.ADJ PRESSURE-1	Adjustable Pressure	0120-0300 Standard Models-Copeland 0151-0201 High Efficiency Models 0130-0250 Standard Models-Bitzer	Fan closest to the header is not cycled.	\$2,980
FCY.ADJ PRESSURE-2	Adjustable Pressure	0350-0400 Standard Models 0251-0301 High Efficiency Models 0300-0350 Standard Models-Bitzer	Fan closest to the header is not cycled.	\$3,548
FCY.ADJ PRESSURE-3	Adjustable Pressure	0351-0401 High Efficiency Models 0400-0500 Standard Models-Bitzer	Fan closest to the header is not cycled.	\$4,047
FSD.AIR FUSED DISCONNECT-1	Air Fused Disconnect	0120-0270 (230V) 0130-0220 (230V)	-	\$2,836
FSD.AIR FUSED DISCONNECT-2	Air Fused Disconnect	0120-0270 (460V) 0300 (230V) Bitzer Model	-	\$4,134
FSD.AIR FUSED DISCONNECT-3	Air Fused Disconnect	0300-0401 (460V)		\$6,017
NFD.AIR NONFUSED DISC-1	Air Non-Fused Disconnect	0120-0270 (230V)		\$2,662
NFD.AIR NONFUSED DISC-2	Air Non-Fused Disconnect	0120-0270 (460V) 0300 (230V) Bitzer Model		\$3,830
NFD.AIR NONFUSED DISC-3	Air Non-Fused Disconnect	0300-0401 (460V)		\$5,603
CBK.002-2	Compressor Circuit Breaker	230V		\$4,399
CBK.002-1	Compressor Circuit Breaker	460V		\$2,044
PLM.PLM	Phase Loss Monitor	230V and 460V		\$1,925
TDR.COMP ANTI SHORT	Anti-short cycling timer	All		\$1,109
HPS.MANUAL RESET	Manual Reset High Pressure Switch	All		\$533
MTR.VSEC_TITLE 24-2L	Variable Speed EC w/ Title 24 motor kit	0150-0300M Standard Models (230V & 460V) 0120-0300L Standard Models (230V & 460V) 0151-0201M High Efficiency Model (230 & 460V) 0150-0250M Bitzer Models (230V & 460V) 0130-0300L Bitzer Models (230V & 460V)		\$31,906
MTR.VSEC_TITLE 24-3L	Variable Speed EC w/ Title 24 motor kit	0350-0400M Standard Models (230V & 460V) 0251-0301M High Efficiency Models (230V & 460V) 0300-0350M Bitzer Models (230V & 460V) 0400L Bitzer Model (230V & 460V)		\$46,045
MTR.VSEC_TITLE 24-4L	Variable Speed EC w/ Title 24 motor kit	0351-0401M High Efficiency Models (230V & 460V) 0400-0500M Bitzer Models (230V & 460V)		\$63,810



FACTORY INSTALLED: A LA CARTE OPTIONS

Mechanical Options

Option Code	Description	Models Used On	Notes	Price
LIQ.FILTER_SG_RCFD-1	RC Filter Drier and Sight Glass	0120-0221	-	\$793
LIQ.FILTER_SG_RCFD-2	RC Filter Drier and Sight Glass	0250-0401	-	\$1,166
LIQ.FILTER_SG_RCFD-3	RC Filter Drier and Sight Glass	0500 Bitzer Model		\$1,398
LIQ.FILTER_SG_SV-1	Filter Drier, Sight Glass, and Solenoid Valve	0120-0221	Not recommended on applications with line runs more than 25 feet.	\$1,598
LIQ.FILTER_SG_SV-2	Filter Drier, Sight Glass, and Solenoid Valve	0250-0401	Not recommended on applications with line runs more than 25 feet.	\$1,713
LIQ.FILTER_SG_SV-3	Filter Drier, Sight Glass, and Solenoid Valve	0500 Bitzer Model	Not recommended on applications with line runs more than 25 feet.	\$2,058
SUC.FILTER-1	Filter	0120-0221	-	\$2,155
SUC.FILTER-2	Filter	0250-0401	-	\$2,760
SUC.FILTER-3	Filter	0500 Bitzer Model		\$3,449
SUC.FILTER_RC-1	RC Filter	0120-0221	-	\$2,817
SUC.FILTER_RC-2	RC Filter	0250-0401	-	\$2,943
SUC.FILTER_RC-3	RC Filter	0500 Bitzer Model		\$3,679
SUC.ACCUMULATOR-1	Accumulator	0120-0221	-	\$4,601
SUC.ACCUMULATOR-2	Accumulator	0250-0401	-	\$5,282
SUC.ACCUMULATOR-3	Accumulator	0500 Bitzer Model		\$6,861
DIS.OIL SEP_CHECK VLV-1	Oil Separator with discharge line check valve	0120-0301	-	\$2,761
DIS.OIL SEP_CHECK VLV-2	Oil Separator with discharge line check valve	0350-0401	-	\$4,663
DIS.OIL SEP_CHECK VLV-3	Oil Separator with discharge line check valve	0500 Bitzer Model		\$5,598
MUF.MUFFLER	Discharge muffler	All	-	\$781
DIS.HRV_CHECK VLV-1	3 way heat reclaim valve and check valve	0120-0200	-	\$2,849
DIS.HRV_CHECK VLV-2	3 way heat reclaim valve and check valve	0201-0401	-	\$4,174
UNL.ONE STEP COMP UNL	Compressor unloading with pressure control for 1 cyl. bank	All	-	\$2,828
REC.STD RECEIVER_LOW AMB-1	Standard receiver with low ambient kit (heated/insulated receiver & low pressure bypass time delay relay)	0120-0330	-	\$4,356
REC.STD RECEIVER_LOW AMB-2	Standard receiver with low ambient kit (heated/insulated receiver & low pressure bypass time delay relay)	0350-0500	-	\$5,723

12 - 50 HP VERTICAL AIR-COOLED CONDENSING UNITS



FACTORY INSTALLED: A LA CARTE OPTIONS

Coil Options

Option Code	Description	Models Used On	Notes
CS.PRO RTPF COIL-1	Round Tube Plate Fin BohnGuard/ProKote/Polyester Coil	0120-0330 Standard Models 0151-0201 High Efficiency Models	-
CS.PRO RTPF COIL-2	Round Tube Plate Fin BohnGuard/ProKote/Polyester Coil	0251-0301 High Efficiency Models	-
CS.PRO RTPF COIL-3	Round Tube Plate Fin BohnGuard/ProKote/Polyester Coil	0350-0500 Standard Models	-
CS.PRO RTPF COIL-4	Round Tube Plate Fin BohnGuard/ProKote/Polyester Coil	0351-0401 High Efficiency Models	-
CS.CPR RTPF COIL-1	Round Tube Plate Fin Copper Coil	0120-0300 Standard Models 0151-0201 High Efficiency Models	-
CS.CPR RTPF COIL-2	Round Tube Plate Fin Copper Coil	0251-0301 High Efficiency Models	-
CS.CPR RTPF COIL-3	Round Tube Plate Fin Copper Coil	0350-0500 Standard Models	-
CS.CPR RTPF COIL-4	Round Tube Plate Fin Copper Coil	0351-0401 High Efficiency Models	-

Defrost Options

Option Code	Description	Models Used On	Notes	Price
DFT.TIMER_1 CONT_LOW	Timer & 1 Contactor - Low Amps	0120-0200L (230V) 0150-0201M (460V & 575V) 0120-0300L (460V & 575V)	Includes (1) electric defrost timer, (1) heater & (1) fan contactors, terminal strip	\$3,825
DFT.TIMER_1 CONT_HIGH	Timer & 1 Contactor - High Amps	0120-0200L (230V) 0150-0201M (460V & 575V) 0120-0300L (460V & 575V)	Includes (1) electric defrost timer, (1) heater & (1) fan contactors, terminal strip	\$3,825
DFT.TIMER_2 CONT_LOW	Timer & 2 Contactors - Low Amps	0150-0201M (230V) 0150-0401M (460V & 575V) 0120-0300L (230V, 460V, 575V)	Includes (1) electric defrost timer, (2) heater & (1) fan contactors, terminal strip	\$6,518
DFT.TIMER_2 CONT_HIGH	Timer & 2 Contactors - High Amps	0150-0201M (230V) 0150-0401M (460V & 575V) 0120-0300L (230V, 460V, 575V)	Includes (1) electric defrost timer, (2) heater & (1) fan contactors, terminal strip	\$6,518
DFT.TIMER_4 CONT_LOW	Timer & 4 Contactors - Low Amps	0150-0401M (all voltages) 0150-0300L (all voltages)	Includes (1) electric defrost timer, (4) heater & (1) fan contactors, terminal strip	\$9,986
DFT.TIMER_4 CONT_HIGH	Timer & 4 Contactors - High Amps	0150-0401M (all voltages) 0150-0300L (all voltages)	Includes (1) electric defrost timer, (4) heater & (1) fan contactors, terminal strip	\$9,986
DEF.1 CONT_HIGH_60A	Fuses for electric defrost kits (1H)	0120-0200L (230V) 0150-0201M (460V & 575V) 0120-0301L (460V & 575V)	For systems with one evaporator	\$767
DEF.2 CONT_HIGH_50A	Fuses for electric defrost kits (2H)	0150-0201M (230V) 0150-0401M (460V & 575V) 0120-0301L (230V, 460V, 575V)	For systems with two evaporators	\$1,527
DEF.3 CONT_HIGH_40A	Fuses for electric defrost kits (3H)	0150-0401M (all voltages) 0150-0300L (all voltages)	For systems with up to three evaporators	\$2,302
DEF.4 CONT_HIGH_30A	Fuses for electric defrost kits (4H)	0150-0401M (all voltages) 0150-0300L (all voltages)	For systems with up to four evaporators	\$3,069



12 - 50 HP VERTICAL AIR-COOLED CONDENSING UNITS

FACTORY INSTALLED: A LA CARTE OPTIONS

Defrost Options

Option Code	Description	Models Used On	Notes	Price
EHR.2 EVAP_2 CONT	Evaporator hold out relays - 2 Evaps & 2 Contactors (2L/2H)	0150-0201M (230V)-Copeland 0150-0250M (230V)-Bitzer 0150-0401M (460V & 575V)-Copeland 0150-0500M (460V)-Bitzer 0120-0301L (230V, 460V, 575V)-Copeland 0130-0300L (230V)-Bitzer 0130-0400L (460V)-Bitzer	For use with 2L/2H Electric Defrost Kits with two evaporators	\$591
EHR.2 EVAP_4 CONT	Evaporator hold out relays - 2 Evaps & 4 Contactors (4L/4H)	0150-0201M (230V)-Copeland 0150-0500M (230V & 460V)-Bitzer 0150-0401M (460V & 575V)-Copeland 0120-0301L (230V, 460V, 575V)-Copeland 0130-0400L (230V)-Bitzer 0150-0400L (460V)-Bitzer	For use with 4L/4H Electric Defrost Kits with only two evaporators	\$591
EHR.3 EVAP_3 CONT	Evaporator hold out relays - 3 Evaps & 3 Contactors (3L/3H)	0150-0401M(230V, 460V, 575V)-Copeland 0150-0500M(230V & 460V)-Bitzer 0120-0300L (575V)-Copeland 0150-0300L (230V & 460V)-Copeland 0130-0400L (230V & 460V)-Bitzer	For use with 3L/3H Electric Defrost Kits with three evaporators	\$887
EHR.4 EVAP_4 CONT	Evaporator hold out relays - 4 Evaps & 4 Contactors (4L/4H)	0150-0201M (230V)-Copeland 0150-0500M (230V & 460V)-Bitzer 0150-0401M (460V & 575V)-Copeland 0120-0301L (230V, 460V, 575V)-Copeland 0130-0400L (230V)-Bitzer 0150-0400L (460V)-Bitzer	For use with 4L/4H Electric Defrost Kits with four evaporators	\$1,180
SDK	InterLink™ Smart Defrost Kit™	All	Can not be used alone. Must also select a electric defrost timer or electric defrost kit.	\$1,450
DFT.00X1	Electric Defrost Kit for system with one evaporator	All Models 230 and 460V	Includes (1) electric defrost timer, (1) heater & (1) fan contactors, terminal strip, and fusing. 48 amp maximum heater load per heater contactor.	\$3,824
DFT.00X2	Electric Defrost Kit for system with two evaporators	All Models 230 and 460V	Includes (1) electric defrost timer, (2) heater & (1) fan contactors, terminal strip, and fusing. 48 amp maximum heater load per heater contactor.	\$6,519
DFT.00X3	Electric Defrost Kit for system with three evaporators	All Models 230 and 460V	Includes (1) electric defrost timer, (3) heaters & (1) fan contactor, terminal strip, and fusing. 48 amp maximum heater load per heater contactor.	\$8,358
DFT.00X4	Electric Defrost Kit for system with four evaporators	All Models 230 and 460V	Includes (1) electric defrost timer, (4) heaters & (1) fan contactor, terminal strip, and fusing. 48 amp maximum heater load per heater contactor.	\$9,986
DFT.INTELLIGEN_BEACON	Beacon II/intelliGen™	0150M-0300M Standard Models 0151M-0201M High Efficiency Models 0150M-0250M Bitzer Models 0120L-0300L Standard Models 0130L-0300L Bitzer Models		\$5,059

12 - 50 HP VERTICAL AIR-COOLED CONDENSING UNITS



FACTORY INSTALLED: A LA CARTE OPTIONS

Defrost Options

Option Code	Description	Models Used On	Notes	Price
DFT.INTELLIGEN_BEACON	Beacon II/intelliGen™	0350M-0400M Standard Models 0251M-0401M High Efficiency Models 0300M-0350M Bitzer Models 0400L Bitzer Models		\$5,885
DFT.INTELLIGEN_BEACON	Beacon II/intelliGen™	0400M-0500M Bitzer Models		\$7,385

SHIPPED-LOOSE ACCESSORIES

Crankcase Pressure Regulator (CPR) Valves

A selection program must be used to pick the proper valve. The selection program requires the following inputs: system capacity, suction temperature, and maximum holding temperature. Not available for use on Beacon II™ Outdoor units. Should not be used with MOP type expansion valves in unit coolers. Please contact your local Sales Representative or Account Engineer for assistance.

Size	Part Number	List Price (\$US)
7/8"	29346101	\$715
1 1/8"	29399012	\$1,053
1 3/8"	29394306	\$4,009
1 5/8"	4262Q	\$5,626
2 1/8"	29399089	\$5,160



24-100 HP DUAL VERTICAL AIR-COOLED CONDENSING UNITS

NOMENCLATURE

BRAND L = Larkin	CONDENSING UNIT STYLE D = Outdoor Dual Vertical V = Outdoor Vertical M = Mohave	TEMP RANGE L = Low Temperature M = Medium Temperature	REVISION	COMPRESSOR STYLE D = Discus™ X = Bitzer Semi-Hermetic					
L	C	D	0500	M	C	A	C	D	A0000
PRODUCT IDENTIFIER C = Condensing Unit	HP 0062 = 6 hp 0077 = 7.5 hp 0078 = 7.5 hp 0082 = 8 hp 0092 = 9 hp 0102 = 10 hp 0120/0122 = 12 hp 0130 = 13 hp 0150/0151/0152 = 15 hp 0200/0201/0202 = 20 hp 0220/0222 = 22 hp 0240 = 24 hp 0250/0251/0252 = 25 hp 0260 = 26 hp 0270/0272 = 27 hp 0300/0301/0302 = 30 hp 0330 = 33 hp 0350/0351/0352 = 35 hp 0400/0401/0402 = 40 hp 0440 = 44 hp 0500 = 50 hp 0520 = 52 hp 0540 = 54 hp 0600 = 60 hp 0660 = 66 hp 0700 = 70 hp 0800 = 80 hp 1100 = 100 hp		VOLTAGE C = 208-230/3/60 D = 460/3/60 K = 230/3/60 E = 575/3/60	COMPRESSOR MANUFACTURER C = Copeland B = Bitzer	FACTORY INSTALLED OPTION PACKAGES A#### = Preferred Option Packages C#### = A la Carte Options X#### = Custom Option Packages				

STANDARD FEATURES

- Aluminum Fin Coil
- Adjustable Head Pressure Control (150 psi for Medium Temp. and 100 psi for Low Temp.)
- Sealed Liquid Line Filter Drier (Liquid Standard)
- Liquid Line Sight Glass (Liquid Standard)
- High Pressure Switch-Auto reset
- Low Pressure Switch



24-100 HP DUAL VERTICAL AIR-COOLED CONDENSING UNITS

FEATURES & BENEFITS

QUALITY

- All joints are sweat type connections, no mechanical joints to leak
- Fixed high and adjustable low pressure switch
- Piping is laid out to minimize stress and vibration and is pre-bent to eliminate braze joints where possible to reduce leak potential
- Pressure relief valve on receiver
- Refrigeration duty, rifled copper condenser tubing
- Separate subcooling circuit in condenser for added capacity and vapor free liquid
- Servicemate diagnostic module standard on all non-beacon condensing units
- Sight glass is easily viewable

SERVICEABILITY

- Convenient access panels to easily service internal components
- Large electrical panel to facilitate ease of access
- Manual pumpdown switch on all units
- Lighted e-box with battery back-up

- Hinged venturi fan panels for easy access
- E-box door props

COMPONENTS

- Receivers are sized for sufficient pumpdown capacity with inlet and outlet service valves
- Spring-mounted compressors with suction and discharge eliminators
- High efficiency motors
- High pressure switch-auto reset
- Adjustable head pressure control
- Aluminum fin coil
- Sealed liquid line filter drier (lqd. Std.)
- Liquid line sight glass (lqd. Std.)

CABINET AND CONSTRUCTION

- All units feature the floating tube coil which eliminates tube sheet leaks
- Painted steel cabinet for superior strength and corrosion resistance
- Clevis hook-up brackets to aid unit installation

OUTSTANDING FEATURES

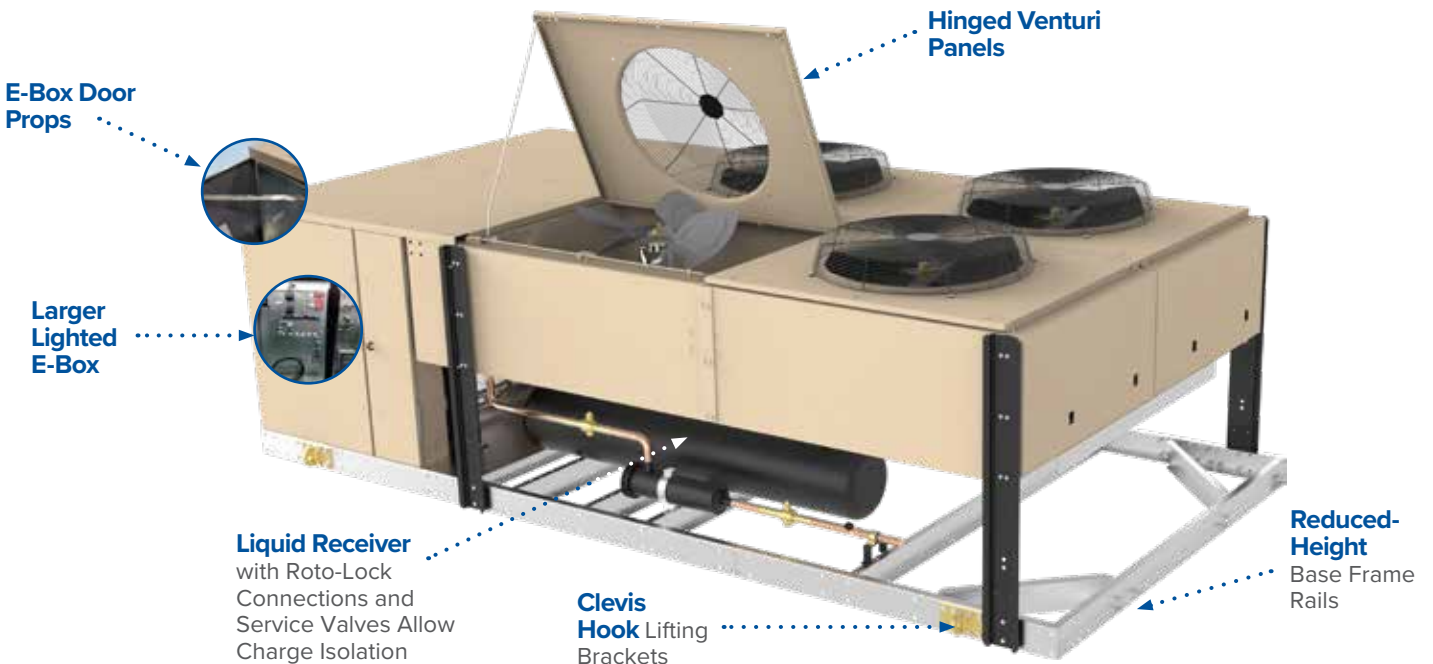

24-100 HP DUAL VERTICAL AIR-COOLED CONDENSING UNITS



PRECONFIGURED OUTDOOR MODELS

See page VCU-17 for description of Factory Installed: Preferred Option Packages

Copeland Discus™ Medium Temperature (R-404A/ R-507A/ R-407A/ R-407C/ R-407F/ R-448A/ R-449A)

Preconfigured Outdoor			Preconfigured Outdoor		
Larkin Model	A0000 Models List Price (US \$)	Voltage	Larkin Model	A0000 Models List Price (US \$)	Voltage
LCD0300MCACD	\$141,112	208-230/3/60	LCD0520MDACD	\$213,204	460/3/60
LCD0300MDACD	\$143,903	460/3/60	LCD0600MCACD	\$219,726	208-230/3/60
LCD0400MCACD	\$157,026	208-230/3/60	LCD0600MDACD	\$222,520	460/3/60
LCD0400MDACD	\$159,805	460/3/60	LCD0700MCACD	\$248,717	208-230/3/60
LCD0500MCACD	\$187,341	208-230/3/60	LCD0700MDACD	\$251,008	460/3/60
LCD0500MDACD	\$190,140	460/3/60	LCD0800MDACD	\$278,134	460/3/60
LCD0520MCACD	\$210,420	208-230/3/60	LCD0800MKACD	\$274,415	230/3/60

Copeland Discus™ Low Temperature (R-404A/ R-507A/ R-407A/ R-407C/ R-407F/ R-448A/ R-449A)

Preconfigured Outdoor			Preconfigured Outdoor		
Larkin Model	A0000 Models List Price (US \$)	Voltage	Larkin Model	A0000 Models List Price (US \$)	Voltage
LCD0240LCACD	\$153,046	208-230/3/60	LCD0440LDACD	\$183,856	460/3/60
LCD0240LDACD	\$155,860	460/3/60	LCD0540LCACD	\$206,975	208-230/3/60
LCD0300LCACD	\$159,820	208-230/3/60	LCD0540LDACD	\$209,695	460/3/60
LCD0300LDACD	\$162,608	460/3/60	LCD0600LCACD	\$228,758	208-230/3/60
LCD0440LCACD	\$181,136	208-230/3/60	LCD0600LDACD	\$231,474	460/3/60

Bitzer Semi-Hermetic Medium Temperature (R-404A/ R-507A/ R-407A/ R-407C/ R-407F/ R-448A/ R-449A)

Preconfigured Outdoor			Preconfigured Outdoor		
Larkin Model	A0000 Models List Price (US \$)	Voltage	Larkin Model	A0000 Models List Price (US \$)	Voltage
LCD0300MCABX	\$141,111	208-230/3/60	LCD0500MDABX	\$207,242	460/3/60
LCD0300MDABX	\$142,803	460/3/60	LCD0600MCABX	\$222,045	208-230/3/60
LCD0400MCABX	\$160,118	208-230/3/60	LCD0600MDABX	\$224,707	460/3/60
LCD0400MDABX	\$162,044	460/3/60	LCD0660MCABX	\$242,049	208-230/3/60
LCD0440MCABX	\$182,325	208-230/3/60	LCD0660MDABX	\$244,954	460/3/60
LCD0440MDABX	\$184,516	460/3/60	LCD0700MCABX	\$270,690	208-230/3/60
LCD0500MCABX	\$204,786	208-230/3/60	LCD0700MDABX	\$273,937	460/3/60
LCD1100MCABX	\$342,395	208-230/3/60	LCD0800MCABX	\$297,700	208-230/3/60
LCD1100MDABX	\$346,506	460/3/60	LCD0800MDABX	\$301,272	460/3/60



24-100 HP DUAL VERTICAL AIR-COOLED CONDENSING UNITS

PRECONFIGURED OUTDOOR MODELS

See page VCU-17 for description of Factory Installed: Preferred Option Packages

Bitzer Semi-Hermetic Low Temperature (R-404A/ R-507A/ R-407A/ R-407C/ R-407F/ R-448A/ R-449A)

Preconfigured Outdoor			Preconfigured Outdoor		
Larkin Model	A0000 Models List Price (US \$)	Voltage	Larkin Model	A0000 Models List Price (US \$)	Voltage
LCD0260LCABX	\$145,939	208-230/3/60	LCD0440LDABX	\$201,996	460/3/60
LCD0260LDABX	\$147,980	460/3/60	LCD0500LCABX	\$221,029	208-230/3/60
LCD0300LCABX	\$162,273	208-230/3/60	LCD0500LDABX	\$224,121	460/3/60
LCD0300LDABX	\$164,546	460/3/60	LCD0600LCABX	\$233,296	208-230/3/60
LCD0400LCABX	\$183,856	208-230/3/60	LCD0600LDABX	\$236,566	460/3/60
LCD0400LDABX	\$186,429	460/3/60	LCD0800LDABX	\$282,037	460/3/60
LCD0440LCABX	\$199,203	208-230/3/60			

24-100 HP DUAL VERTICAL AIR-COOLED CONDENSING UNITS



FACTORY INSTALLED: PREFERRED OPTION PACKAGES

Heatcraft now offers pre-defined kits that represent frequently ordered options or combinations of options. The preferred kits make it easier for customers to configure their units and may provide a savings over factory installed a la carte option selections.

Save money, choose a Preferred Option Package.

Option Code	Description (All Preferred options include Standard Base+)	Models Used On	List Adder (\$US)
A0100	Defrost Timer - Air	All Individually Piped DVCU's	\$1,782
A1002	Lqd Std. Replacable core filter-drier + Replacable core Suction line filter+Accumulator	0240-0440 Individually Piped DVCU's	\$16,427
A1002	Lqd Std. Replacable core filter-drier + Replacable core Suction line filter+Accumulator	0500-0800 Individually Piped DVCU's	\$18,595
A1002	Lqd Std. Replacable core filter-drier + Replacable core Suction line filter+Accumulator	1100 Individually Piped DVCU's	\$23,877
A1003	Replacable core Suction-line filter + Accumulator	0240-0440 Individually Piped DVCU's	\$14,097
A1003	Replacable core Suction-line filter + Accumulator	0500-0800 Individually Piped DVCU's	\$15,453
A1003	Replacable core Suction-line filter + Accumulator	1100 Individually Piped DVCU's	\$20,026
A1004	Pr. Controlled fan cycling + Replacable core Suction-line filter + Accumulator	0240-0600 Individually Piped DVCU's 0260-0500 Individually Piped Bitzer DVCU's	\$19,760
A1004	Pr. Controlled fan cycling + Replacable core Suction-line filter + Accumulator	0700-0800 Individually Piped DVCU's 0600-0700 Individually Piped Bitzer DVCU's	\$22,198
A1004	Pr. Controlled fan cycling + Replacable core Suction-line filter + Accumulator	0800-1100 Individually Piped Bitzer DVCU's	\$27,719
A1300	Oil Separator with discharge line check valve	0240-0600 Individually Piped DVCU's	\$5,239
A1300	Oil Separator with discharge line check valve	0660-0800 Individually Piped DVCU's	\$8,860
A1300	Oil Separator with discharge line check valve	0110 Individually Piped DVCU	\$10,637
A1400	Phase loss monitor	0240-0800 All DVCU's	\$1,829
A0400	Beacon II/intelliGen™	0300M-0600M Standard Models 0300M-0500M Bitzer Models 0240L-0600L Standard Model 0260L-0600L Bitzer Model	\$5,997
A0400	Beacon II/intelliGen™	0700M-0800M Standard Models 0600M-0700M Bitzer Models 0800L Bitzer Model	\$6,647
A0400	Beacon II/intelliGen™	0800M-1100M Bitzer Models	\$10,656
A1500	Parallel Piping	0300M-0600M Standard Models 0240L-0600L Standard Models 0300M-0600M Bitzer Models 0260L-0600L Bitzer Models	\$34,390
A1500	Parallel Piping	0660M-0800M Bitzer Models 0800L Bitzer Models	\$37,506
A1500	Parallel Piping	0700M-0800M Standard Models 1100M Bitzer Models	\$39,351



24-100 HP DUAL VERTICAL AIR-COOLED CONDENSING UNITS

STANDARD CONFIGURABLE OUTDOOR MODELS

Copeland Discus™ Medium Temperature (R-404A/ R-507A/ R-407A/ R-407C/ R-407F/ R-448A/ R-449A)

Standard Base Outdoor					
Larkin Model	List Price (US \$)	Voltage	Larkin Model	List Price (US \$)	Voltage
LCD0300MCACD	\$141,112	208-230/3/60	LCD0600MCACD	\$219,726	208-230/3/60
LCD0300MDACD	\$143,903	460/3/60	LCD0600MDACD	\$222,520	460/3/60
LCD0400MCACD	\$157,026	208-230/3/60	LCD0700MCACD	\$248,717	208-230/3/60
LCD0400MDACD	\$159,805	460/3/60	LCD0700MDACD	\$251,008	460/3/60
LCD0500MCACD	\$187,341	208-230/3/60	LCD0800MKACD	\$274,415	230/3/60
LCD0500MDACD	\$190,140	460/3/60	LCD0800MDACD	\$278,134	460/3/60
LCD0520MCACD	\$210,420	208-230/3/60			
LCD0520MDACD	\$213,204	460/3/60			

Copeland Discus™ Low Temperature (R-404A/ R-507A/ R-407A/ R-407C/ R-407F/ R-448A/ R-449A)

Preconfigured Outdoor			Preconfigured Outdoor		
Larkin Model	A0000 Models List Price (US \$)	Voltage	Larkin Model	A0000 Models List Price (US \$)	Voltage
LCD0240LCACD	\$153,046	208-230/3/60	LCD0440LDACD	\$183,856	460/3/60
LCD0240LDACD	\$155,860	460/3/60	LCD0540LCACD	\$206,975	208-230/3/60
LCD0300LCACD	\$159,820	208-230/3/60	LCD0540LDACD	\$209,695	460/3/60
LCD0300LDACD	\$162,608	460/3/60	LCD0600LCACD	\$228,758	208-230/3/60
LCD0440LCACD	\$181,136	208-230/3/60	LCD0600LDACD	\$231,474	460/3/60

Bitzer Semi-Hermetic Medium Temperature (R-404A/ R-507A/ R-407A/ R-407C/ R-407F/ R-448A/ R-449A)

Standard Base Outdoor					
Larkin Model	List Price (US \$)	Voltage	Larkin Model	List Price (US \$)	Voltage
LCD0300MCABX	\$141,111	208-230/3/60	LCD0660MCABX	\$242,049	208-230/3/60
LCD0300MDABX	\$142,803	460/3/60	LCD0660MDABX	\$244,954	460/3/60
LCD0400MCABX	\$160,118	208-230/3/60	LCD0700MCABX	\$270,690	208-230/3/60
LCD0400MDABX	\$162,044	460/3/60	LCD0700MDABX	\$273,937	460/3/60
LCD0440MCABX	\$182,325	208-230/3/60	LCD0800MCABX	\$297,700	208-230/3/60
LCD0440MDABX	\$184,516	460/3/60	LCD0800MDABX	\$301,272	460/3/60
LCD0500MCABX	\$204,786	208-230/3/60	LCD1100MCABX	\$342,395	208-230/3/60
LCD0500MDABX	\$207,242	460/3/60	LCD1100MDABX	\$346,506	460/3/60
LCD0600MCABX	\$222,045	208-230/3/60			
LCD0600MDABX	\$224,707	460/3/60			

24-100 HP DUAL VERTICAL AIR-COOLED CONDENSING UNITS



STANDARD CONFIGURABLE OUTDOOR MODELS

Bitzer Semi-Hermetic Low Temperature (R-404A/ R-507A/ R-407A/ R-407C/ R-407F/ R-448A/ R-449A)

Standard Base Outdoor					
Larkin Model	List Price (US \$)	Voltage	Larkin Model	List Price (US \$)	Voltage
LCD0260LCABX	\$145,939	208-230/3/60	LCD0500LCABX	\$221,029	208-230/3/60
LCD0260LDABX	\$147,980	460/3/60	LCD0500LDABX	\$224,121	460/3/60
LCD0300LCABX	\$162,273	208-230/3/60	LCD0600LCABX	\$233,296	208-230/3/60
LCD0300LDABX	\$164,546	460/3/60	LCD0600LDABX	\$236,566	460/3/60
LCD0400LCABX	\$183,856	208-230/3/60	LCD0800LDABX	\$282,037	460/3/60
LCD0400LDABX	\$186,429	460/3/60			
LCD0440LCABX	\$199,203	208-230/3/60			
LCD0440LDABX	\$201,996	460/3/60			



24-100 HP DUAL VERTICAL AIR-COOLED CONDENSING UNITS

FACTORY INSTALLED: A LA CARTE OPTIONS

Electrical Options

Option Code	Description	Models Used On	Notes	List Adder (\$US)
FCY.ADJ TEMP-1	Adjustable Temperature	0240-0600 Individually Piped	Fan closest to the header is not cycled.	\$5,961
FCY.ADJ TEMP_PP-1	Adjustable Temperature	0240-0600 Parallel Piped	Fan closest to the header is not cycled.	\$4,822
FCY.ADJ TEMP-2	Adjustable Temperature	0700-0800 Individually Piped 0600-0700 Individually Piped Bitzer Models	Fan closest to the header is not cycled.	\$7,100
FCY.ADJ TEMP_PP-2	Adjustable Temperature	0700-0800 Parallel Piped 0600-0700 Parallel Piped Bitzer Models	Fan closest to the header is not cycled.	\$5,961
FCY.ADJ TEMP-3	Adjustable Temperature	0800-1100 Individually Piped Bitzer Models	Fan closest to the header is not cycled.	\$8,098
FCY.ADJ TEMP_PP-3	Adjustable Temperature	0800-1100 Parallel Piped Bitzer Models	Fan closest to the header is not cycled.	\$6,960
FCY.ADJ PRESSURE-1	Adjustable Pressure	0240-0600 Individually Piped	Fan closest to the header is not cycled.	\$5,961
FCY.ADJ PRESSURE_PP-1	Adjustable Pressure	0240-0600 Parallel Piped	Fan closest to the header is not cycled.	\$4,822
FCY.ADJ PRESSURE-2	Adjustable Pressure	0700-0800 Individually Piped 0600-0700 Individually Piped Bitzer Models	Fan closest to the header is not cycled.	\$7,100
FCY.ADJ PRESSURE_PP-2	Adjustable Pressure	0700-0800 Parallel Piped 0600-0700 Parallel Piped Bitzer Models	Fan closest to the header is not cycled.	\$5,961
FCY.ADJ PRESSURE-3	Adjustable Pressure	0800-1100 Individually Piped Bitzer Models	Fan closest to the header is not cycled.	\$8,098
FCY.ADJ PRESSURE_PP-3	Adjustable Pressure	0800-1100 Parallel Piped Bitzer Models	Fan closest to the header is not cycled.	\$6,960
CBK.002-2	Compressor Circuit Breakers	230V - Individually and Parallel Piped	No CBK options are available for the 0800 units.	\$8,807
CBK.002-1	Compressor Circuit Breakers	460V - Individually and Parallel Piped	No CBK options are available for the 0800 units.	\$4,094
PLM.PLM	Phase Loss Monitors	230V & 460V - Individually and Parallel Piped	-	\$1,925
TDR.COMP ANTI SHORT	Anti-short Cycling Timers	All - Individually Piped	-	\$2,221
TDR.COMP ANTI SHORT_PP	Anti-short Cycling Timers	All - Parallel Piped	-	\$1,109
HPS.MANUAL RESET	Manual Reset High Pressure Switches	All - Individually and Parallel Piped	-	\$1,058
MTR.VSEC_TITLE 24-4L-1	Variable Speed EC w/ Title 24 motor kit	0300-0600M Parallel Piped Standard Models (230V & 460V) 0240-0600L Parallel Piped Standard Models(230V & 460V) 0260-0600L Parallel Piped Bitzer Models(230V & 460V) 0300-0500M Parallel Piped Bitzer Models (230V & 460V)	-	\$60,181
MTR.VSEC_TITLE 24-4L-2	Variable Speed EC w/ Title 24 motor kit	0300-0600M Individually Piped Standard Models (230V & 460V) 0240-0600L Individually Piped Standard Models(230V & 460V) 0260-0600L Individually Piped Bitzer Models(230V & 460V) 0300-0500M Individually Piped Bitzer Models (230V & 460V)	-	\$63,810
MTR.VSEC_TITLE 24-6L-1	Variable Speed EC w/ Title 24 motor kit	0700-0800M Parallel Piped Standard Models (230V & 460V) 0600-0700M Parallel Piped Bitzer Unit (230V & 460V) 0800L Parallel Piped Bitzer Unit (230V & 460V)	-	\$88,457
MTR.VSEC_TITLE 24-6L-2	Variable Speed EC w/ Title 24 motor kit	0700-0800M Individually Piped (230V & 460V) 0600-0700M Individually Piped Bitzer Unit (230V & 460V) 0800L Individually Piped Bitzer Unit (230V & 460V)	-	\$92,086

24-100 HP DUAL VERTICAL AIR-COOLED CONDENSING UNITS



FACTORY INSTALLED: A LA CARTE OPTIONS

Electrical Options

Option Code	Description	Models Used On	Notes	List Adder (\$US)
MTR.VSEC_TITLE 24-8L-1	Variable Speed EC w/ Title 24 motor kit	0800-1100M Parallel Piped Bitzer Units (230V & 460V)		\$116,734
MTR.VSEC_TITLE 24-8L-2	Variable Speed EC w/ Title 24 motor kit	0800-1100M Individually Piped Bitzer Units (230V & 460V)		\$120,363

Mechanical Options

Option Code	Description	Models Used On	Notes	List Adder (\$US)
LIQ.FILTER_SG_RCFD-1	RC Filter Drier and Sight Glass	0240-0440 Individually Piped	-	\$1,588
LIQ.FILTER_SG_RCFD_PP-1	RC Filter Drier and Sight Glass	0240-0440 Parallel Piped	-	Standard
LIQ.FILTER_SG_RCFD-2	RC Filter Drier and Sight Glass	0500-0800 Individually Piped	-	\$2,329
LIQ.FILTER_SG_RCFD_PP-2	RC Filter Drier and Sight Glass	0500-0800 Parallel Piped	-	Standard
LIQ.FILTER_SG_RCFD-3	RC Filter Drier and Sight Glass	1100 Individually Piped Bitzer Unit		\$2,797
LIQ.FILTER_SG_RCFD_PP-3	RC Filter Drier and Sight Glass	1100 Parallel Piped Bitzer Unit		Standard
LIQ.FILTER_SG_SV-1	Filter Drier, Sight Glass, and Solenoid Valve	0240-0440 Individually Piped	Not recommended on applications with line runs more than 25 feet.	\$3,192
LIQ.FILTER_SG_RCFD_SV_PP-1	Filter Drier, Sight Glass, and Solenoid Valve	0240-0440 Parallel Piped	Not recommended on applications with line runs more than 25 feet.	\$1,713
LIQ.FILTER_SG_SV-2	Filter Drier, Sight Glass, and Solenoid Valve	0500-0800 Individually Piped	Not recommended on applications with line runs more than 25 feet.	\$3,428
LIQ.FILTER_SG_RCFD_SV_PP-2	Filter Drier, Sight Glass, and Solenoid Valve	0500-0800 Parallel Piped	Not recommended on applications with line runs more than 25 feet.	\$2,308
LIQ.FILTER_SG_SV-3	Filter Drier, Sight Glass, and Solenoid Valve	1100 Individually Piped Bitzer Unit	Not recommended on applications with line runs more than 25 feet.	\$3,192
LIQ.FILTER_SG_RCFD_SV_PP-3	Filter Drier, Sight Glass, and Solenoid Valve	1100 Parallel Piped Bitzer Unit	Not recommended on applications with line runs more than 25 feet.	\$2,906
SUC.FILTER-1	Filter	0240-0400 Individually Piped	-	\$4,304
SUC.FILTER_PP-1	Filter	0240-0400 Parallel Piped	-	N/A
SUC.FILTER-2	Filter	0440-0800 Individually Piped	-	\$5,515
SUC.FILTER_PP-2	Filter	0440-0800 Parallel Piped	-	N/A
SUC.FILTER-3	Filter	1100 Individually Piped Bitzer Unit		\$6,901



24-100 HP DUAL VERTICAL AIR-COOLED CONDENSING UNITS

FACTORY INSTALLED: A LA CARTE OPTIONS

Mechanical Options

Option Code	Description	Models Used On	Notes	List Adder (\$US)
SUC.FILTER_PP-3	Filter	1100 Parallel Piped Bitzer Unit		N/A
SUC.FILTER_RC-1	RC Filter	0240-0400 Individually Piped	-	\$5,636
SUC.FILTER_RC_PP-1	RC Filter	0240-0400 Parallel Piped	-	Standard
SUC.FILTER_RC-2	RC Filter	0440-0800 Individually Piped	-	\$5,889
SUC.FILTER_RC_PP-2	RC Filter	0440-0800 Parallel Piped	-	Standard
SUC.FILTER_RC-3	RC Filter	1100 Individually Piped	-	\$7,359
SUC.ACCUMULATOR-1	Accumulator	0240-0400 Individually Piped	-	\$9,203
SUC.ACCUMULATOR_PP-1	Accumulator	0240-0400 Parallel Piped	-	Standard
SUC.ACCUMULATOR-2	Accumulator	0440-0800 Individually Piped	-	\$10,552
SUC.ACCUMULATOR_PP-2	Accumulator	0440-0800 Parallel Piped	-	Standard
SUC.ACCUMULATOR-3	Accumulator	1100 Individually Piped Bitzer Unit	-	\$13,721
SUC.ACCUMULATOR_PP-3	Accumulator	1100 Parallel Piped Bitzer Unit	-	Standard
DIS.OIL_SEP_CHECK_VLV-1	Oil separators with discharge line check valves	0240-0600 Individually Piped	-	\$5,515
DIS.OIL_SEP_CHECK_VLV_PP-1	Oil separators with discharge line check valves	0240-0600 Parallel Piped	-	Standard
DIS.OIL_SEP_CHECK_VLV-2	Oil separators with discharge line check valves	0700-0800 Individually Piped	-	\$9,326
DIS.OIL_SEP_CHECK_VLV_PP-2	Oil separators with discharge line check valves	0700-0800 Parallel Piped	-	Standard
DIS.OIL_SEP_CHECK_VLV-3	Oil separators with discharge line check valves	0700-0800 Individually Piped	-	\$11,197
DIS.OIL_SEP_CHECK_VLV_PP-3	Oil separators with discharge line check valves	0700-0800 Parallel Piped	-	Standard
MUF.MUFFLER	Discharge mufflers	All - Individually Piped	-	\$1,565
DIS.HRV_CHECK_VLV-1	3 way heat reclaim valve and check valve	0240-0440 Individually Piped	-	\$8,346
DIS.HRV_CHECK_VLV_PP-1	3 way heat reclaim valve and check valve	0240-0440 Parallel Piped	-	Call Factory
DIS.HRV_CHECK_VLV-2	3 way heat reclaim valve and check valve	0500-0600 Individually Piped 0440-0800 Individually Piped Bitzer Units	-	\$10,871
DIS.HRV_CHECK_VLV_PP-2	3 way heat reclaim valve and check valve	0500-0600 Parallel Piped 0440-0800 Parallel Piped Bitzer Units	-	Call Factory
DIS.HRV_CHECK_VLV-3	3 way heat reclaim valve and check valve	0700-0800 Individually Piped 1100 Individually Piped Bitzer Unit	-	\$15,747
DIS.HRV_CHECK_VLV_PP-3	3 way heat reclaim valve and check valve	0700-0800 Parallel Piped 1100 Parallel Piped Bitzer Unit	-	Call Factory
UNL.ONE STEP COMP UNL	Compressor unloading with pressure control for 1 cyl. bank	All - Individually and Parallel Piped	-	\$5,664
DMD.DMD COOLING	Demand Cooling	0240-0600L Individually and Parallel Piped	-	\$7,981
REC.STD RECEIVER_LOW AMB-1	Standard receiver with low ambient kit (heated/insulated receiver & low pressure bypass time delay relay)	0240-0600 Individually and Parallel Piped	-	\$8,715

24-100 HP DUAL VERTICAL AIR-COOLED CONDENSING UNITS



FACTORY INSTALLED: A LA CARTE OPTIONS

Mechanical Options

Option Code	Description	Models Used On	Notes	List Adder (\$US)
REC.STD RECEIVER_LOW AMB-2	Standard receiver with low ambient kit (heated/insulated receiver & low pressure bypass time delay relay)	0700-0800 Individually and Parallel Piped 0600-1100 Individually and Parallel Piped Bitzer Unit	-	\$11,447

Coil Options

Option Code	Description	Models Used On	List Adder (\$US)
CS.PRO RTPF COIL-1	Round Tube Plate Fin BohnGuard/ProKote/Polyester Coil	0240-0500 Standard Models 0300M Bitzer Model 0260-0400L Bitzer Models	\$5,600
CS.PRO RTPF COIL-2	Round Tube Plate Fin BohnGuard/ProKote/Polyester Coil	0520-0600 0400-0500M Bitzer Models 0440-0600L Bitzer Models	\$9,326
CS.PRO RTPF COIL-3	Round Tube Plate Fin BohnGuard/ProKote/Polyester Coil	0700-0800 0600-0700M Bitzer Models 0800L Bitzer Model	\$10,453
CS.PRO RTPF COIL-4	Round Tube Plate Fin BohnGuard/ProKote/Polyester Coil	0800-1100M Bitzer Models	\$13,936
CSB.CPR RTPF COIL-1	Copper condenser fins	0240-0500	Call Factory
CSB.CPR RTPF COIL-2	Copper condenser fins	0520-0600	Call Factory
CSB.CPR RTPF COIL-3	Copper condenser fins	0700-0800	Call Factory



24-100 HP DUAL VERTICAL AIR-COOLED CONDENSING UNITS

FACTORY INSTALLED: A LA CARTE OPTIONS

Defrost Options

Option Code	Description	Models Used On	Notes	List Adder (\$US)
DFT.TIMER_1 CONT	Electric Defrost Kit for system with one evaporator per compressor circuit	0300-0400M (230V) Individually Piped 0240-0600L (230V) Individually Piped 0240-0800 (460V) Individually Piped	Includes (1) electric defrost timer, (1) heater & (1) fan contactors, terminal strip	\$6,115
DFT.TIMER_1 CONT-1	Electric Defrost Kit for system with one evaporator per compressor circuit	0300-0400M (230V) Individually Piped Bitzer Models 0260-0440L (230V) Individually Piped Bitzer Models All (460V) Individually Piped Bitzer Models	Includes (1) electric defrost timer, (1) heater & (1) fan contactors, terminal strip and fusing. 48 amp maximum heater load per heater contactor	\$7,646
DFT.TIMER_1 CONT_PP	Electric Defrost Kit for system with one evaporator per compressor circuit	0300-0400M (230V) Parallel Piped 0240-0600L (230V) Parallel Piped 0240-0800 (460V) Parallel Piped	Includes (1) electric defrost timer, (1) heater & (1) fan contactors, terminal strip	\$5,176
DFT.TIMER_1 CONT_PP-1	Electric Defrost Kit for system with one evaporator per compressor circuit	0300-0400M (230V) Parallel Piped Bitzer Models 0260-0440L (230V) Parallel Piped Bitzer Models All (460V) Parallel Piped Bitzer Models	Includes (1) electric defrost timer, (1) heater & (1) fan contactors, terminal strip and fusing. 48 amp maximum heater load per heater contactor	\$6,711
DFT.TIMER_1 CONT-2	Electric Defrost Kit for system with one evaporator per compressor circuit	0440-1100M (230V) Individually Piped Bitzer Models 0500-0800L (230V) Individually Piped Bitzer Models	Includes (1) electric defrost timer, (1) heater & (1) fan contactors, terminal strip and fusing. 48 amp maximum heater load per heater contactor	\$7,646
DFT.TIMER_1 CONT_PP-2	Electric Defrost Kit for system with one evaporator per compressor circuit	0440-1100M (230V) Parallel Piped Bitzer Models 0500-0800L (230V) Parallel Piped Bitzer Models	Includes (1) electric defrost timer, (1) heater & (1) fan contactors, terminal strip and fusing. 48 amp maximum heater load per heater contactor	\$6,711
DFT.TIMER_2 CONT	Electric Defrost Kit for system with two evaporators per compressor circuit	0300-0520M (230V) Individually Piped 0240-0600L (230V) Individually Piped 0240-0800 (460V) Individually Piped	Includes (1) electric defrost timer, (2) heater & (1) fan contactors, terminal strip	\$8,807
DFT.TIMER_2 CONT-1	Electric Defrost Kit for system with two evaporators per compressor circuit	0300-0600M (230V) Individually Piped Bitzer Models All L (230V) Individually Piped Bitzer Models All (460V) Individually Piped Bitzer Models	Includes (1) electric defrost timer, (2) heater & (1) fan contactors, terminal strip and fusing. 48 amp maximum heater load per heater contactor	\$13,045
DFT.TIMER_2 CONT_PP	Electric Defrost Kit for system with two evaporators per compressor circuit	0300-0520M (230V) Parallel Piped 0240-0600L (230V) Parallel Piped 0240-0800 (460V) Parallel Piped	Includes (1) electric defrost timer, (2) heater & (1) fan contactors, terminal strip	\$7,866
DFT.TIMER_2 CONT_PP-1	Electric Defrost Kit for system with two evaporators per compressor circuit	0300-0400M (230V) Parallel Piped Bitzer Models 0260-0440L (230V) Parallel Piped Bitzer Models All (460V) Parallel Piped Bitzer Models	Includes (1) electric defrost timer, (2) heater & (1) fan contactors, terminal strip and fusing. 48 amp maximum heater load per heater contactor	\$12,162
DFT.TIMER_2 CONT-2	Electric Defrost Kit for system with two evaporators per compressor circuit	0660-1100M (230V) Individually Piped Bitzer Models	Includes (1) electric defrost timer, (2) heater & (1) fan contactors, terminal strip and fusing. 48 amp maximum heater load per heater contactor	\$13,045
DFT.TIMER_2 CONT_PP-2	Electric Defrost Kit for system with two evaporators per compressor circuit	0440-1100M (230V) Parallel Piped Bitzer Models	Includes (1) electric defrost timer, (2) heater & (1) fan contactors, terminal strip and fusing. 48 amp maximum heater load per heater contactor	\$12,162

24-100 HP DUAL VERTICAL AIR-COOLED CONDENSING UNITS



FACTORY INSTALLED: A LA CARTE OPTIONS

Defrost Options

Option Code	Description	Models Used On	Notes	List Adder (\$US)
DEF.XXX1	Fuses for electric defrost kit for system with one evaporator per compressor circuit	0300-0400M (230V) Individually and Parallel Piped 0240-0600L (230V) Individually and Parallel Piped 0240-0800 (460V) Individually and Parallel Piped	-	\$1,527
DEF.XXX2	Fuses for electric defrost kit for system with two evaporators per compressor circuit	0300-05200M (230V) Individually and Parallel Piped 0240-0600L (230V) Individually and Parallel Piped 0240-0800 (460V) Individually and Parallel Piped	-	\$3,057
SDK	InterLink™ Smart Defrost Kit™	All Models	Can not be used alone. Must also select a electric defrost timer or electric defrost kit.	\$2,906
DFT.INTELLIGEN_ BEACON	Beacon II/intelliGen™	0300M-0600M Standard Models 0300M-0500M Bitzer Models 0240L-0600L Standard Model 0260L-0600L Bitzer Model		\$6,313
DFT.INTELLIGEN_ BEACON	Beacon II/intelliGen™	0700M-0800M Standard Models 0600M-0700M Bitzer Models 0800L Bitzer Model		\$6,997
DFT.INTELLIGEN_ BEACON	Beacon II/intelliGen™	0800M-1100M Bitzer Models		\$11,217



DVCU SHIPPED-LOOSE ACCESSORIES

Crankcase Pressure Regulator (CPR) Valves

A selection program must be used to pick the proper valve. The selection program requires the following inputs: system capacity, suction temperature, and maximum holding temperature. Not available for use on Beacon II™ Outdoor units. Should not be used with MOP type expansion valves in unit coolers. Please contact your local Sales Representative or Account Engineer for assistance.

Size	Part Number	List Price (\$US)
7/8"	29346101	\$715
1 1/8"	29399012	\$1,053
1 3/8"	29394306	\$4,009
1 5/8"	4262Q	\$5,626
2 1/8"	29399089	\$5,160
2 5/8"	29314001	\$11,676



WATER COOLED CONDENSING UNITS

1/2 - 6 HP

The 1/2 through 6 HP water cooled condensing unit product line features hermetic and scroll® compressors. These condensing units' component selection, location, base and unit dimensions are all optimized for easy field replacement or installation in new applications where space is limited. The electrical box is designed with extra space for easier servicing. The area is large enough to accommodate circuit breakers, compressor contactors, time clocks and all start components in one enclosure. Standard features include: compressor isolation valves that enable service technicians to isolate the compressor for service and an oversized receiver which provides total refrigerant pump down. These products are ideal for units requiring long runs.



NOMENCLATURE



ZW	N	010	L	6	B
Compressor	Application	Model Size	Operating Range	Refrigerant	Voltage
HW = Hermetic ZW = Scroll®	N = Indoor	005-060	H = High L = Low M = Medium X = Extended Temp.	6 = R-404A/R-507A, R-407A/R-407C, R-448A/R-449A	B = 208-230/1/60 C = 208-230/3/60 D = 460/3/60

OVERVIEW

Cabinet & Construction

- Component location and unit size are optimized for easy field replacement and space limited applications

Serviceability

- Large electrical box allows easy service and installation of additional components
- A pump-down switch is provided on all models for easy field servicing
- Color-coded wire harnesses are labeled and coded for easy identification
- Suction line rotolock service valve is provided on the compressor for service
- An additional shut-off valve is mounted in the discharge line of the compressor for quick and easy compressor isolation

Quality

- Sight glass (optional) is easily viewable
- Every unit is subjected to a helium leak test to ensure the unit is leak free
- Shipped with nitrogen holding charge to enable installer to verify unit is leak-free upon arrival
- Every unit is run-tested and cycled on both the high and low pressure controls
- All electrical circuits are also tested for functional integrity

Components

- Features Copeland hermetic and Scroll® compressors
- Compressors are mounted with vibration eliminating rubber grommets
- All units come standard with a water regulating valve for superior head pressure control
- Oversized receiver with liquid shut-off valve is provided for installations with long refrigerant lines



WATER COOLED CONDENSING UNITS

1/2 - 6 HP

CONFIGURABLE MODELS PRICING

Standard Features

- Compressor mounting (rubber grommets)
- Compressor discharge service valve (in line brass base valve)
- Compressor suction service valve — rotolock
- Large capacity refrigerant receiver (up to 100 ft. runs)
- Receiver service valve (located on outlet)
- Coaxial condenser (counterflow tube in tube)
- Extra large electric box (encloses all options and start components)
- Electric conduit (UL recognized, high impact, flame retardant copolymer)
- Low pressure control switch (adjustable)
- High pressure encapsulated safety switch (fixed)
- Superhose on low pressure control (higher leak resistance)
- Liquid injection (Scroll® — low temperature models only)
- Pump-down control switch (pre-wired)
- Water valve (mounted on condenser inlet)
- Agency approvals UL, ULC

Need to customize? Look at the factory-installed options.

Larkin Model	List Price (\$US)	Voltage	Notes
Hermetic High Temperature (R-404A/R-507A, R-407A/R-407C, R-448A/R-449A)			
HWN005H6B	6,219	208-230/1/60	See footnote 1
HWN009H6B	6,568	208-230/1/60	See footnote 1
HWN010H6B	7,144	208-230/1/60	See footnote 1
HWN010H6C	7,405	208-230/3/60	See footnote 1
HWN015H6B	7,469	208-230/1/60	-
HWN015H6C	7,865	208-230/3/60	-
HWN025H6B	8,962	208-230/1/60	-
HWN025H6C	9,653	208-230/3/60	-
HWN032H6B	11,179	208-230/1/60	-
HWN032H6C	11,625	208-230/3/60	-
Hermetic Extended Temperature (R-404A/R-507A, R-407A/R-407C, R-448A/R-449A)			
HWN005X6B	6,219	208-230/1/60	See footnote 1
HWN008X6B	6,360	208-230/1/60	See footnote 1
HWN009X6B	6,568	208-230/1/60	See footnote 1
HWN010X6B	7,144	208-230/1/60	See footnote 1
HWN010X6C	7,405	208-230/3/60	See footnote 1
Hermetic Extended/Medium Temperature (R-404A/R-507A, R-407A/R-407C, R-448A/R-449A)			
HWN015X6B	7,469	208-230/1/60	-
HWN015X6C	7,865	208-230/3/60	-

Larkin Model	List Price (\$US)	Voltage	Notes
HWN020X6B	8,310	208-230/1/60	-
HWN020X6C	9,080	208-230/3/60	-
HWN025X6B	8,962	208-230/1/60	-
HWN025X6C	9,653	208-230/3/60	-
HWN025X6D	10,292	460/3/60	-
HWN030X6B	10,638	208-230/1/60	-
HWN030X6C	11,041	208-230/3/60	-
HWN030X6D	11,504	460/3/60	-
HWN032X6B	11,179	208-230/1/60	-
HWN032X6C	11,625	208-230/3/60	-
HWN032X6D	12,027	460/3/60	-
Hermetic Low Temperature (R-404A/R-507A, R-407A/R-407C, R-448A/R-449A)			
HWN011L6B	7,422	208-230/1/60	-
HWN011L6C	7,568	208-230/3/60	-
HWN014L6B	7,514	208-230/1/60	-
HWN014L6C	7,730	208-230/3/60	-
HWN025L6B	7,827	208-230/1/60	-
HWN025L6C	8,041	208-230/3/60	-
HWN031L6B	11,281	208-230/1/60	-
HWN031L6C	11,565	208-230/3/60	-
HWN031L6D	11,766	460/3/60	-

Notes:

- Suitable for R-407C
- Scroll “L6” models must have a liquid line option specified.



WATER COOLED CONDENSING UNITS

1/2 - 6 HP

CONFIGURABLE MODELS PRICING

Larkin Model	List Price (\$US)	Voltage	Notes
Scroll Extended Temperature (R-404A/R-507A, R-407A/R- 407C, R-448A/R-449A)			
ZWN010X6B	12,681	208-230/1/60	-
ZWN010X6C	12,814	208-230/3/60	-
ZWN010X6D	13,303	460/3/60	-
ZWN015X6B	13,608	208-230/1/60	-
ZWN015X6C	13,743	208-230/3/60	-
ZWN015X6D	14,232	460/3/60	-
ZWN020X6B	13,944	208-230/1/60	-
ZWN020X6C	14,081	208-230/3/60	-
ZWN020X6D	14,571	460/3/60	-
ZWN025X6B	14,196	208-230/1/60	-
ZWN025X6C	14,330	208-230/3/60	-
ZWN025X6D	14,822	460/3/60	-
ZWN030X6B	14,516	208-230/1/60	-
ZWN030X6C	14,713	208-230/3/60	-
ZWN030X6D	15,384	460/3/60	-
ZWN035X6B	15,469	208-230/1/60	-
ZWN035X6C	15,671	208-230/3/60	-
ZWN035X6D	16,152	460/3/60	-
ZWN045X6B	16,066	208-230/1/60	-
ZWN045X6C	16,301	208-230/3/60	-
ZWN045X6D	16,762	460/3/60	-
ZWN055X6B	16,535	208-230/1/60	-
ZWN055X6C	16,770	208-230/3/60	-
ZWN055X6D	17,516	460/3/60	-
ZWN060X6C	19,530	208-230/3/60	-
ZWN060X6D	19,855	460/3/60	-

Larkin Model	List Price (\$US)	Voltage	Notes
Scroll Low Temperature (R-404A/R-507A, R-407A/R-407C, R-448A/R-449A)			
ZWN020L6B	13,777	208-230/1/60	See footnote 2
ZWN020L6C	13,995	208-230/3/60	See footnote 2
ZWN020L6D	14,248	460/3/60	See footnote 2
ZWN025L6B	15,041	208-230/1/60	See footnote 2
ZWN025L6C	15,260	208-230/3/60	See footnote 2
ZWN025L6D	15,428	460/3/60	See footnote 2
ZWN030L6B	15,282	208-230/1/60	See footnote 2
ZWN030L6C	15,519	208-230/3/60	See footnote 2
ZWN030L6D	17,457	460/3/60	See footnote 2
ZWN035L6B	16,092	208-230/1/60	See footnote 2
ZWN035L6C	16,332	208-230/3/60	See footnote 2
ZWN035L6D	16,728	460/3/60	See footnote 2
ZWN045L6B	16,811	208-230/1/60	See footnote 2
ZWN045L6C	17,037	208-230/3/60	See footnote 2
ZWN045L6D	17,436	460/3/60	See footnote 2
ZWN055L6B	17,483	208-230/1/60	See footnote 2
ZWN055L6C	17,697	208-230/3/60	See footnote 2
ZWN055L6D	18,115	460/3/60	See footnote 2
ZWN060L6C	19,970	208-230/3/60	See footnote 2
ZWN060L6D	21,068	460/3/60	See footnote 2

Notes:

1. Suitable for R-407C
2. Scroll "L6" models must have a liquid line option specified.



WATER COOLED CONDENSING UNITS

1/2 - 6 HP

FACTORY-INSTALLED OPTIONS

Need Factory-Installed Options?

- Make sure you have selected a configurable model. When ordering, remember to specify the option codes and list price adders for each selected option.
- Can't Find Something? Other options and accessories might be available on a custom order basis. Please contact your local Sales Representative or Account Engineer for assistance.

Option Code	Description	Models Used On	Notes	List Price Adder (\$US)
Electrical Options				
DFT.001	Defrost Timer - Air	All H2, X6	Medium temperature applications only.	912
Mechanical Options				
LIQ.001-1	Liquid-line Drier & Sight Glass	005-025	-	855
LIQ.001-2	Liquid-line Drier & Sight Glass	030-060	-	992
LIQ.002-1	Liquid-line Drier, Sight Glass & Solenoid Valve	005-025	-	1,823
LIQ.002-2	Liquid-line Drier, Sight Glass & Solenoid Valve	030-060	-	1,961
SUC.003-1	Suction-line filter	005-025	-	544
SUC.003-2	Suction-line filter	030-060	-	645
SUC.007-1	Suction accumulator	005-025	-	685
SUC.007-2	Suction accumulator	027-060	-	1,141
SUC.004-1	Suction-line filter & accumulator	005-025	-	1,229
SUC.004-2	Suction-line filter & accumulator	030-060	-	1,786



FACTORY-INSTALLED ELECTRIC DEFROST OPTIONS

Need an electric defrost timer or kit?

- Make sure you have selected a configurable model. When ordering, remember to specify the option codes and list price adders for each selected option.
- Electric defrost kits and components are available to be factory mounted in the electrical box of indoor or outdoor condensing units used in medium/low temp applications with electric defrost evaporators.

Selecting the proper kit is as easy as ...

- Add up the total fan motor amps and electric heater amps for all evaporators in the refrigeration system.
- For the selected condensing unit, find the rated defrost power amps for both the fan motor amps and electric heater amps.
- If the evaporator total fan motor amps and electric defrost heater amps calculated in Step 1 are less than the condensing unit's rated defrost power amps found in Step 2 then proceed below to select the appropriate kit/components and list price adders. If not then contact your local Sales Representative or Account Engineer for assistance.

Definitions

Electric Defrost Timer

Initiates and terminates defrost cycles based on a predetermined time schedule.

Lockout Relay

Prevents the electric defrost heaters from energizing when the compressor is in operation. Not available on electric defrost timer only options.

Fan Contactor

Carries amperage load for evaporator fan motors.

Heater Contactor

Carries amperage load for evaporator electric defrost heaters.

InterLink™ Smart Defrost Kit™ (SDK)

The InterLink™ SDK is a revolutionary product that is designed to be used on any electric defrost walk-in freezer system with an electro-mechanical defrost timer set for three or more scheduled defrosts per day. The InterLink™ SDK accurately estimates frost accumulation on the evaporator coil and decides if it can skip the preprogrammed defrost period that is set on the defrost timer. This helps eliminate unneeded defrost cycles, saving energy and increasing product integrity

Option Code	Description	Models Used On	Notes	List Price Adder (\$US)
DFT.002	Defrost Timer - Electric	005-060 L6, H2, X6 (208-230V)	-	912
DFT.007	Electric Defrost Kit	HWN: 040-050 H2, X6 (208-230V) ZWN: 030-060 X6, L6 (208-230V) All: 015-060 H2, X6, L6 (460V)	Includes (1) electric defrost timer, (1) heater & (1) fan contactors, and (1) lockout relay.	1,298
SDK.001	InterLink™ Smart Defrost Kit™	005-060 and L6, H2, X6	Can not be used alone. Must also select a electric defrost timer or electric defrost kit.	1,408



SHIPPED-LOOSE ACCESSORIES

A wide range of shipped-loose accessories are available to order. Can't Find Something? Other options and accessories might be available on a custom order basis. Please contact your local Sales Representative or Account Engineer for assistance.

Crankcase Pressure Regulator (CPR) Valves

A selection program must be used to pick the proper valve. The selection program requires the following inputs: system capacity, suction temperature, and maximum holding temperature. Should not be used with MOP type expansion valves in unit coolers. Please contact your local Sales Representative or Account Engineer for assistance.

Size	Part Number	List Price (\$US)
5/8"	2930142	522
7/8"	29346101	715
1 1/8"	29399012	1,053
1 3/8"	29394306	4,009



WATER COOLED CONDENSING UNITS

3/4 - 22 HP

The 3/4 through 22 HP water-cooled condensing unit product line features semi-hermetic compressors. These condensing units are “vessel-mounted” indoor watercooled condensing units complete with a shell and tube condenser. The cleanable condenser is perfect for applications where air-cooled condensers would not be practical and/or areas where water is readily available. These units provide an economical, compact alternative to traditional air-cooled condensing units.

NOMENCLATURE



S	W	N	0075	L	6	B
Compressor	Model	Application	Model Size	Operating Range	Refrigerant	Electrical Code
S = Semi-Hermetic Reciprocating	W = Water Cooled	N = Indoor	0075-2200	H = High L = Low M = Medium E = Extra Low	6 = R-404A/R-507A, R-407A/R-407C, R-448A/R-449A	B = 208-230/1/60 C = 208-230/3/60 D = 460/3/60 E = 575/3/60

OVERVIEW

Cabinet & Construction

- Component location and unit size are optimized for easy field replacement and space limited applications

Serviceability

- Spacious, pre-painted electrical box
- Pump-down switch
- Easy access refrigerant piping
- Captive door fasteners
- Single electrical connection location
- Removable electrical box provides convenient front access to the oil pump and compressor

Quality

- Pre-bent tubing reduces the possibility of leaks
- Shipped with a dry nitrogen holding charge
- Heavy duty metal base plate
- Non-metallic conduit on all wiring runs

Components

- Semi-hermetic reciprocating compressors
- Rigid mounted compressors on models 0075-0400 and spring mounted compressors with suction and discharge vibration eliminators on models 0499 and above
- Fixed low pressure switch (adjustable on low temperature models)
- Fixed high pressure switch
- Sealed liquid line filter drier and sight glass



WATER COOLED CONDENSING UNITS

3/4 - 22 HP

CONFIGURABLE MODELS PRICING

Standard Features

- Solid mounted semi-hermetic Reed and Discus® compressors up to and including 0400
- Spring mounted compressor 0499 and above
- Oil pressure switch (where required)
- High-low pressure controls
- Compressor contactor
- Shell and tube water-cooled condenser with pressure relief
- Liquid-line filter drier and sight glass
- Pump-down switch

Need to customize? Look at the factory-installed options starting on page WC-9.

Larkin Model	List Price (\$US)	Voltage	Notes
Semi-Hermetic Medium Temperature (R-404A/R-507A, R-407A/R-407C, R-448A/R-449A)			
SWN0090M6B	15,290	208-230/1/60	-
SWN0090M6C	15,497	208-230/3/60	-
SWN0199M6B	17,932	208-230/1/60	-
SWN0199M6C	18,045	208-230/3/60	-
SWN0200M6C	20,011	208-230/3/60	-
SWN0310M6C	23,454	208-230/3/60	-
SWN0310M6D	25,753	460/3/60	-
SWN0310M6E	26,267	575/3/60	-
SWN0500M6C	27,563	208-230/3/60	See footnote 1
SWN0500M6D	30,061	460/3/60	See footnote 1
Semi-Hermetic Low Temperature (R-404A/R-507A, R-407A/R-407C, R-448A/R-449A)			
SWN0150L6B	16,640	208-230/1/60	-
SWN0150L6C	16,721	208-230/3/60	-
SWN0150L6D	19,219	460/3/60	-
SWN0200L6C	20,200	208-230/3/60	-
SWN0210L6B	20,513	208-230/1/60	-
SWN0210L6C	20,200	208-230/3/60	-
SWN0210L6D	22,786	460/3/60	-
SWN0210L6E	23,240	575/3/60	-
SWN0310E6C	22,901	208-230/3/60	-
SWN0310E6D	25,476	460/3/60	-
SWN0310L6C	22,901	208-230/3/60	-
SWN0310L6D	25,476	460/3/60	-
SWN0310L6E	25,985	575/3/60	-
SWN0311L6C	27,511	208-230/3/60	See footnote 2
SWN0311L6D	30,084	460/3/60	See footnote 2
SWN0311L6E	30,687	575/3/60	See footnote 2
SWN0400L6C	29,499	208-230/3/60	See footnote 2

Larkin Model	List Price (\$US)	Voltage	Notes
SWN0400L6D	32,133	460/3/60	See footnote 2
SWN0400L6E	32,772	575/3/60	See footnote 2
SWN0599L6C	30,375	208-230/3/60	See footnote 2
SWN0599L6D	32,952	460/3/60	See footnote 2
SWN0599L6E	33,617	575/3/60	See footnote 2
SWN0600L6C	32,386	208-230/3/60	See footnote 2
SWN0600L6D	34,964	460/3/60	See footnote 2
SWN0600L6E	35,665	575/3/60	See footnote 2
SWN0601L6C	34,401	208-230/3/60	See footnote 2
SWN0601L6D	36,981	460/3/60	See footnote 2
SWN0601L6E	37,725	575/3/60	See footnote 2
SWN0750L6C	37,174	208-230/3/60	See footnote 2
SWN0750L6D	40,343	460/3/60	See footnote 2
SWN0750L6E	41,151	575/3/60	See footnote 2
SWN0900L6C	41,321	208-230/3/60	See footnote 2
SWN0900L6D	44,496	460/3/60	See footnote 2
SWN0900L6E	45,384	575/3/60	See footnote 2
SWN1000L6C	45,369	208-230/3/60	See footnote 2
SWN1000L6D	46,823	460/3/60	See footnote 2
SWN1000L6E	47,759	575/3/60	See footnote 2
SWN1500L6C	54,925	208-230/3/60	See footnote 2
SWN1500L6D	56,321	460/3/60	See footnote 2
SWN1500L6E	57,449	575/3/60	See footnote 2
SWN2200L6C	64,303	208-230/3/60	See footnote 2
SWN2200L6D	65,693	460/3/60	See footnote 2
SWN2200L6E	67,004	575/3/60	See footnote 2

Notes:

1. Suitable for R-407A, R-407C, R-448A/R-449A
2. Suitable for R-407A, R-407C, R407F



FACTORY-INSTALLED OPTIONS

Need Factory-Installed Options?

- Make sure you have selected a configurable model. When ordering, remember to specify the option codes and list price adders for each selected option.
- Can't Find Something? Other options and accessories might be available on a custom order basis. Please contact your local Sales Representative or Account Engineer for assistance.

Option Code	Description	Models Used On	Notes	List Price Adder (\$US)
Electrical Options				
DFT.001	Defrost Timer - Air	All H2, M2, M6	Medium temperature applications only.	912
CBK.001-1	Circuit Breakers (Compressor & Control Circuit)	0075-0311 (208-230/1/60or 230V/1/60)	-	794
CBK.001-2	Circuit Breakers (Compressor & Control Circuit)	0075-2000 (230V/3/60)	-	936
CBK.001-3	Circuit Breakers (Compressor & Control Circuit)	0100-2200 (460V/3/60)	-	2,244
CBK.001-4	Circuit Breakers (Compressor & Control Circuit)	2200L6C	-	3,545
CCH.001	Crankcase Heater	All	-	516
SW.002	Dual pressure control with adjustable high & low pressure settings	All	-	249
Mechanical Options				
LIQ.003	Replaceable core liquid-line filter drier & sight glass	0300-2200	-	1,398
LIQ.002-1	Liquid-line solenoid valve	0075-0400	Not recommended on applications with line runs more than 25 feet.	1,012
LIQ.002-2	Liquid-line solenoid valve	0499-0900	Not recommended on applications with line runs more than 25 feet.	1,131
LIQ.002-3	Liquid-line solenoid valve	1000-2200	Not recommended on applications with line runs more than 25 feet.	1,552
CMT.002	Spring Mounted Compressor	0075-0400	Includes discharge and suction vibration eliminators. Standard on 0499 and above	688
SUC.003-1	Suction-line filter	0075-0210	-	571
SUC.003-2	Suction-line filter	0300-0400	-	1,309
SUC.005	Replaceable core suction-line filter	0300-0400	-	2,058
SUC.007-1	Suction accumulator	0075-0210	-	851
SUC.007-2	Suction accumulator	0300-0400	-	1,325
SUC.010	Suction-line filter	0499-2200	-	2,022
SUC.012	Replaceable core suction-line filter	0500-2200	-	2,058
SUC.014-1	Suction accumulator	0499-1000	-	2,120
SUC.014-2	Suction accumulator	1500H2-2000H2 & 1500L6-2200L6	-	3,875
DIS.001	Oil separator with discharge line check valve	0300-0400	-	2,147
DIS.009-1	Oil separator with discharge line check valve	0499-0500	-	2,147
DIS.009-2	Oil separator with discharge line check valve	0599-1000	-	2,266
DIS.009-3	Oil separator with discharge line check valve	1500-2200	-	2,681



FACTORY-INSTALLED ELECTRIC DEFROST OPTIONS

Need an electric defrost timer or kit?

- Make sure you have selected a configurable model. When ordering, remember to specify the option codes and list price adders for each selected option.
- Electric defrost kits and components are available to be factory mounted in the electrical box of indoor or outdoor condensing units used in medium/low temp applications with electric defrost evaporators.

Selecting the proper kit is as easy as ...

- Add up the total fan motor amps and electric heater amps for all evaporators in the refrigeration system.
- For the selected condensing unit, find the rated defrost power amps for both the fan motor amps and electric heater amps.
- If the evaporator total fan motor amps and electric defrost heater amps calculated in Step 1 are less than the condensing unit's rated defrost power amps found in Step 2 then proceed below to select the appropriate kit/components and list price adders. If not then contact your local Sales Representative or Account Engineer for assistance.

Definitions

Electric Defrost Timer

Initiates and terminates defrost cycles based on a predetermined time schedule.

Lockout Relay

Prevents the electric defrost heaters from energizing when the compressor is in operation. Not available on electric defrost timer only options.

Fan Contactor

Carries amperage load for evaporator fan motors.

Heater Contactor

Carries amperage load for evaporator electric defrost heaters.

InterLink™ Smart Defrost Kit™ (SDK)

The InterLink™ SDK is a revolutionary product that is designed to be used on any electric defrost walk-in freezer system with an electro-mechanical defrost timer set for three or more scheduled defrosts per day. The InterLink™ SDK accurately estimates frost accumulation on the evaporator coil and decides if it can skip the preprogrammed defrost period that is set on the defrost timer. This helps eliminate unneeded defrost cycles, saving energy and increasing product integrity

Option Code	Description	Models Used On	Notes	List Price Adder (\$US)
DFT.028-1	Electric Defrost Kit (Low Amps)	0075-1000, 1500-2200 (460V)	Includes (1) electric defrost timer, (1 or 2) heater & (1) fan contactors, terminal strip	1,601
DFT.028-2	Electric Defrost Kit (Low Amps)	1500-2200 (230V)	Includes (1) electric defrost timer, (1 or 2) heater & (1) fan contactors, terminal strip	2,354
DFT.029-1	Electric Defrost Kit (High Amps)	0150H2B, 0199M6B, 0300-0601, 0750-1000 (460V)	Includes (1) electric defrost timer, (1 or 2) heater & (1) fan contactors, terminal strip	1,601
DFT.029-2	Electric Defrost Kit (High Amps)	0750-1000 (230V), 1500-2200	Includes (1) electric defrost timer, (1 or 2) heater & (1) fan contactors, terminal strip	2,354
DEF.067-1	Fuses for electric defrost kits (Low Amps)	0075-1000	-	661
DEF.067-2	Fuses for electric defrost kits (Low Amps)	1500-2200	-	936
DEF.068-1	Fuses for electric defrost kits (High Amps)	0150H2B, 0199M6B, 0300-0601	-	661
DEF.068-2	Fuses for electric defrost kits (High Amps)	0750-2200	-	936
SDK.001	InterLink™ Smart Defrost Kit™	All	Can not be used alone. Must also select a electric defrost timer or electric defrost kit.	1,408



WATER COOLED CONDENSING UNITS

3/4 - 22 HP

SHIPPED-LOOSE ACCESSORIES

A wide range of shipped-loose accessories are available to order. Can't Find Something? Other options and accessories might be available on a custom order basis. Please contact your local Sales Representative or Account Engineer for assistance.

Part Number	Description	Models Used On	Notes	List Price (\$US)
Mechanical Options				
2935028	Water Regulating Valve	0075-0311	-	622
2935031	Water Regulating Valve	0400-0601	-	622
2935041	Water Regulating Valve	0750-0900	-	2,003
2935042	Water Regulating Valve	1000, 1500L6, 2200L6	-	2,003
87409001	Water Regulating Valve	1500H2, 2000H2	-	5,379
50055901	Two Tier Rack (Small)	0075 - 1000	-	5,652
50055902	Two Tier Rack (Large)	1500 - 2200	-	5,652

Crankcase Pressure Regulator (CPR) Valves

A selection program must be used to pick the proper valve. The selection program requires the following inputs: system capacity, suction temperature, and maximum holding temperature. Should not be used with MOP type expansion valves in unit coolers. Please contact your local Sales Representative or Account Engineer for assistance.

Size	Part Number	List Price (\$US)
5/8"	2930142	522
7/8"	29346101	715
1 1/8"	29399012	1,053
1 3/8"	29394306	4,009
1 5/8"	4262Q	5,626



REMOTE COMPRESSOR UNITS

3/4 - 22 HP

The indoor SRN and ZRN remote compressor units feature semi-hermetic or Scroll® compressors. These units are specially designed for use in supermarket restaurant, warehouse and other commercial and industrial applications.

The design focuses on easy of installation and maintenance along with the flexibility to fit most application requirements.

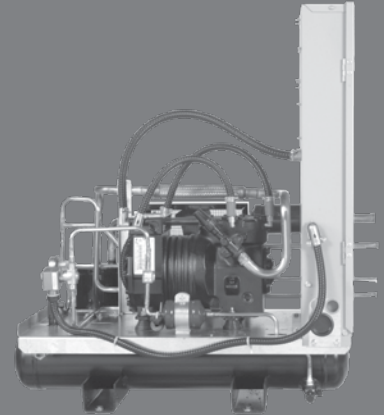

NOMENCLATURE



S	R	N	020	H	2	C
Compressor	Model	Application	Model Size	Operating Range	Refrigerant	Electrical Code
S = Semi-Hermetic Reciprocating Z = Remote Scroll®	R = Remote	N = Indoor	020-2200	H = High L = Low M = Medium E = Extra Low X = Extended Temp.	6 = R-404A/R-507A, R-407A/R-407C, R-448A/R-449A	B = 208-230/1/60 C = 208-230/3/60 D = 460/3/60 E = 575/3/60

OVERVIEW

Cabinet & Construction

- Spacious, pre-painted electrical box
- Fixed low pressure switch (adjustable on low temp models)
- Fixed high pressure switch
- Pump down switch
- 230V control circuit transformer on 460V units
- Standard 16-3/4" tall box - (large 29-1/4" tall box is standard when defrost components are selected)
- Sealed liquid line filter drier and sight glass

Serviceability

- Easy access refrigerant piping
- Captive door fasteners
- Single electrical connection location
- Removable electrical box provides convenient front access to the oil pump and compressor

Quality

- Every unit is subjected to a helium leak test to ensure the unit is leak free
- Shipped with nitrogen holding charge to enable installer to verify unit is leak-free upon arrival
- All the units are completely leak tested in a helium environment, compressor is bump tested and high and low pressure controls are cycled. Each unit has a copy of the run data shipped inside the electrical panel.

Components

- Pre-bent tubing reduces the possibility of leaks
- Shipped with dry nitrogen charge
- Heavy duty base plate
- Non-metallic conduit on all wiring runs



CONFIGURABLE MODELS PRICING

Standard Features

- Solid mounted semi-hermetic Reed and Discus® compressors up to and including 0400
- Spring mounted compressor 0499 and above
- Oil pressure switch (where required)
- High-low pressure controls
- Compressor contactor
- Liquid receiver with pressure relief
- Liquid-line filter drier and sight glass (except ZRN020-060)
- Pump-down switch

Need to customize? Look at the factory-installed options.

Larkin Model	List Price (\$US)	Voltage	Notes
Semi-Hermetic Medium Temperature (R-404A/R-507A, R-407A/R-407C, R-448A/R-449A)			
SRN0090M6B	13,004	208-230/1/60	-
SRN0090M6C	13,233	208-230/3/60	-
SRN0199M6B	15,307	208-230/1/60	-
SRN0199M6C	15,230	208-230/3/60	-
SRN0200M6C	16,945	208-230/3/60	-
SRN0310M6C	18,750	208-230/3/60	-
SRN0310M6D	21,044	460/3/60	-
SRN0500M6C	21,892	208-230/3/60	See footnote 1
SRN0500M6D	24,881	460/3/60	See footnote 1
Semi-Hermetic Low Temperature (R-404A/R-507A, R-407A/ R-407C, R-448A/R-449A)			
SRN0150L6B	13,877	208-230/1/60	-
SRN0150L6C	13,861	208-230/3/60	-
SRN0150L6D	16,441	460/3/60	-
SRN0200L6C	17,135	208-230/3/60	-
SRN0210L6B	17,135	208-230/1/60	-
SRN0210L6C	17,444	208-230/3/60	-
SRN0210L6D	19,720	460/3/60	-
SRN0310E6C	18,889	208-230/3/60	-
SRN0310E6D	21,469	460/3/60	-
SRN0310L6C	18,889	208-230/3/60	-
SRN0310L6D	21,469	460/3/60	-
SRN0311L6C	22,583	208-230/3/60	See footnote 2
SRN0311L6D	25,160	460/3/60	See footnote 2
SRN0400L6C	24,747	208-230/3/60	See footnote 2
SRN0400L6D	27,328	460/3/60	See footnote 2
SRN0599L6C	25,740	208-230/3/60	See footnote 2
SRN0599L6D	28,319	460/3/60	See footnote 2

Larkin Model	List Price (\$US)	Voltage	Notes
SRN0600L6C	25,921	208-230/3/60	See footnote 2
SRN0600L6D	28,499	460/3/60	See footnote 2
SRN0601L6C	27,170	208-230/3/60	See footnote 2
SRN0601L6D	29,752	460/3/60	See footnote 2
SRN0750L6C	31,747	208-230/3/60	See footnote 2
SRN0750L6D	34,923	460/3/60	See footnote 2
SRN0900L6C	33,544	208-230/3/60	See footnote 2
SRN0900L6D	36,709	460/3/60	See footnote 2
SRN1000L6C	37,095	208-230/3/60	See footnote 2
SRN1000L6D	37,431	460/3/60	See footnote 2
SRN1500L6C	44,264	208-230/3/60	See footnote 2
SRN1500L6D	45,664	460/3/60	See footnote 2
SRN2200L6C	50,838	208-230/3/60	See footnote 2
SRN2200L6D	52,232	460/3/60	See footnote 2
Scroll Extended Temperature (R-404A/R-507A, R-407A/R- 407C, R-448A/R-449A)			
ZRN020X6B	11,922	208-230/1/60	-
ZRN020X6C	12,117	208-230/3/60	-
ZRN020X6D	12,790	460/3/60	-
ZRN025X6B	11,712	208-230/1/60	-
ZRN025X6C	11,907	208-230/3/60	-
ZRN025X6D	12,579	460/3/60	-
ZRN030X6B	12,661	208-230/1/60	-
ZRN030X6C	12,857	208-230/3/60	-
ZRN030X6D	13,529	460/3/60	-
ZRN035X6B	12,450	208-230/1/60	-
ZRN035X6C	12,658	208-230/3/60	-
ZRN035X6D	13,137	460/3/60	-
ZRN045X6B	13,053	208-230/1/60	-

Notes:

1. Suitable for R-407A, R-407C, R-448A/R-449A
2. Suitable for R-407A, R-407C, R407F
3. Scroll "L6" models must have a liquid line option specified.



CONFIGURABLE MODELS PRICING

Larkin Model	List Price (\$US)	Voltage	Notes
ZRN045X6C	13,282	208-230/3/60	-
ZRN045X6D	13,745	460/3/60	-
ZRN055X6B	12,761	208-230/1/60	-
ZRN055X6C	13,001	208-230/3/60	-
ZRN055X6D	13,744	460/3/60	-
ZRN060X6C	14,520	208-230/3/60	-
ZRN060X6D	14,843	460/3/60	-

Scroll Medium Temperature (R-404A/R-507A, R-407A/R- 407C, R-448A/R-449A)

ZRN0650M6C	20,490	208-230/3/60	-
ZRN0650M6D	23,665	460/3/60	-
ZRN0700M6C	21,960	208-230/3/60	-
ZRN0700M6D	25,137	460/3/60	-
ZRN0750M6C	22,600	208-230/3/60	-
ZRN0750M6D	25,780	460/3/60	-
ZRN0860M6C	24,566	208-230/3/60	-
ZRN0860M6D	25,935	460/3/60	-
ZRN1000M6C	29,455	208-230/3/60	-
ZRN1000M6D	30,847	460/3/60	-
ZRN1400M6C	33,235	208-230/3/60	-
ZRN1400M6D	34,626	460/3/60	-

Scroll Low Temperature (R-404A/R-507A, R-407A/R-407C, R-448A/R-449A)

ZRN020L6B	13,024	208-230/1/60	See Footnote 3
ZRN020L6C	13,259	208-230/3/60	See Footnote 3
ZRN020L6D	15,202	460/3/60	See Footnote 3
ZRN025L6B	13,539	208-230/1/60	See Footnote 3
ZRN025L6C	13,777	208-230/3/60	See Footnote 3
ZRN025L6D	15,714	460/3/60	See Footnote 3
ZRN030L6B	14,351	208-230/1/60	See Footnote 3
ZRN030L6C	14,588	208-230/3/60	See Footnote 3
ZRN030L6D	16,526	460/3/60	See Footnote 3
ZRN035L6B	14,867	208-230/1/60	See Footnote 3
ZRN035L6C	15,107	208-230/3/60	See Footnote 3
ZRN035L6D	15,504	460/3/60	See Footnote 3
ZRN045L6B	15,585	208-230/1/60	See Footnote 3

Larkin Model	List Price (\$US)	Voltage	Notes
ZRN045L6C	15,809	208-230/3/60	See Footnote 3
ZRN045L6D	16,209	460/3/60	See Footnote 3
ZRN055L6B	15,950	208-230/1/60	See Footnote 3
ZRN055L6C	16,168	208-230/3/60	See Footnote 3
ZRN055L6D	16,584	460/3/60	See Footnote 3
ZRN060L6C	18,118	208-230/3/60	See Footnote 3
ZRN060L6D	19,211	460/3/60	See Footnote 3
ZRN0750L6C	24,707	208-230/3/60	-
ZRN0750L6D	27,282	460/3/60	-
ZRN1000L6C	30,733	208-230/3/60	-
ZRN1000L6D	33,910	460/3/60	-
ZRN1300L6C	33,255	208-230/3/60	-
ZRN1300L6D	36,424	460/3/60	-
ZRN1500L6C	36,187	208-230/3/60	-
ZRN1500L6D	36,524	460/3/60	-

Notes:

1. Suitable for R-407A, R-407C, R-448A/R-449A
2. Suitable for R-407A, R-407C, R407F
3. Scroll "L6" models must have a liquid line option specified.



FACTORY-INSTALLED OPTIONS

Need Factory-Installed Options?

- Make sure you have selected a configurable model. When ordering, remember to specify the option codes and list price adders for each selected option.
- Can't Find Something? Other options and accessories might be available on a custom order basis. Please contact your local Sales Representative or Account Engineer for assistance.

Option Code	Description	Models Used On	Notes	List Price Adder (\$US)
Electrical Options				
DFT.001	Defrost Timer - Air	All H2, M2, M6, X6	Medium temperature applications only.	912
CBK.001-1	Circuit Breakers (Compressor & Control Circuit)	0075-0311 (208-230/1/60 or 230V/1/60)	-	794
CBK.001-2	Circuit Breakers (Compressor & Control Circuit)	0075-2000 (230V/3/60)	-	936
CBK.001-3	Circuit Breakers (Compressor & Control Circuit)	0100-2200 (460V/3/60)	-	2244
CBK.001-4	Circuit Breakers (Compressor & Control Circuit)	2200L6C	-	3545
CCH.001	Crankcase Heater	All SRN	-	516
SW.002	Dual pressure control with adjustable high & low pressure settings	0075-2200	-	249
Mechanical Options				
LIQ.001	Liquid-line filter drier & sight glass	020-060 ZRN	Required on all L6 models with scroll compressors.	992
LIQ.002-1	Liquid-line solenoid valve	0075-0400	Not recommended on applications with line runs more than 25 feet.	1012
LIQ.002-2	Liquid-line solenoid valve	0499-0900 SRN, 0650-0750M6 ZRN, 0750-1300L6 ZRN	Not recommended on applications with line runs more than 25 feet.	1131
LIQ.002-3	Liquid-line solenoid valve	1000-2200 SRN, 0860-1400M6 ZRN, 1500L6 ZRN	Not recommended on applications with line runs more than 25 feet.	1,552
LIQ.002-4	Liquid-line solenoid valve	020-060 ZRN	Not recommended on applications with line runs more than 25 feet.	1,961
LIQ.003	Replaceable core liquid-line filter drier & sight glass	0300-2200 SRN, 0650-1500 ZRN	-	1,398
SUC.003-1	Suction-line filter	0075-0210 SRN	-	571
SUC.003-2	Suction-line filter	020-060 ZRN	-	645
SUC.003-3	Suction-line filter	0750-1500L6 ZRN	-	1309
SUC.003-4	Suction-line filter	0650-1400M6 ZRN	-	2,022
SUC.005	Replaceable core suction-line filter	0310-0400 SRN, 0650-1500 ZRN	-	2,058
SUC.010	Suction-line filter	0499-2200 SRN	-	2,022
SUC.012	Replaceable core suction-line filter	0300 & 0499-2200 SRN	-	2,058
SUC.007-1	Suction accumulator	0075-0210 SRN	-	851
SUC.007-2	Suction accumulator	020-060 ZRN	-	1141
SUC.007-3	Suction accumulator	0300-0400 SRN, 0750L6-1500L6 ZRN	-	1325
SUC.007-4	Suction accumulator	0650M6-1400M6 ZRN	-	2,120
SUC.014-1	Suction accumulator	0499-1000 SRN	-	2,120
SUC.014-2	Suction accumulator	1500-2200 SRN	-	3,875
DIS.001-1	Oil separator with discharge line check valve	0300-0400 SRN, 0750L6-1500L6 ZRN	-	2,147
DIS.001-2	Oil separator with discharge line check valve	0650M6-1400M6 ZRN	-	2,266
DIS.004-1	Head pressure control flooding valve, fixed	020-060 ZRN	-	808
DIS.004-2	Head pressure control flooding valve, fixed	0075-0400 SRN, 0650-1500 ZRN	-	826
DIS.009-1	Oil separator with discharge line check valve	0499-0500 SRN	-	2,147
DIS.009-2	Oil separator with discharge line check valve	0599-1000 SRN	-	2,266
DIS.009-3	Oil separator with discharge line check valve	1500-2200 SRN	-	2,681
DIS.010-1	Head pressure control flooding valve, fixed	0499-1000 SRN	-	826
DIS.010-2	Head pressure control flooding valve, fixed	1500-2200 SRN	-	1,401



FACTORY-INSTALLED ELECTRIC DEFROST OPTIONS

Need an electric defrost timer or kit?

- Make sure you have selected a configurable model. When ordering, remember to specify the option codes and list price adders for each selected option.
- Electric defrost kits and components are available to be factory mounted in the electrical box of indoor or outdoor condensing units used in medium/low temp applications with electric defrost evaporators.

Selecting the proper kit is as easy as ...



Add up the total fan motor amps and electric heater amps for all evaporators in the refrigeration system.



For the selected condensing unit, find the rated defrost power amps for both the fan motor amps and electric heater amps.



If the evaporator total fan motor amps and electric defrost heater amps calculated in Step 1 are less than the condensing unit's rated defrost power amps found in Step 2 then proceed below to select the appropriate kit/components and list price adders. If not then contact your local Sales Representative or Account Engineer for assistance.

Definitions

Electric Defrost Timer

Initiates and terminates defrost cycles based on a predetermined time schedule.

Lockout Relay

Prevents the electric defrost heaters from energizing when the compressor is in operation. Not available on electric defrost timer only options.

Fan Contactor

Carries amperage load for evaporator fan motors.

Heater Contactor

Carries amperage load for evaporator electric defrost heaters.

InterLink™ Smart Defrost Kit™ (SDK)

The InterLink™ SDK is a revolutionary product that is designed to be used on any electric defrost walk-in freezer system with an electro-mechanical defrost timer set for three or more scheduled defrosts per day. The InterLink™ SDK accurately estimates frost accumulation on the evaporator coil and decides if it can skip the preprogrammed defrost period that is set on the defrost timer. This helps eliminate unneeded defrost cycles, saving energy and increasing product integrity

Option Code	Description	Models Used On	Notes	List Price Adder (\$US)
DFT.002	Defrost Timer - Electric	ZRN: 020-060X6/L6	-	912
DFT.007	Electric Defrost Kit	ZRN: 020-060X6/L6	Includes (1) electric defrost timer, (1) heater & (1) fan contactors, and (1) lockout relay.	1,298
DFT.028-1	Electric Defrost Kit (Low Amps)	SRN: 0075-1000 & 1500-2200 (460V); ZRN: 0650-0860 (230V) & 0650-1500 (460V)	Includes (1) electric defrost timer, (1 or 2) heater & (1) fan contactors, terminal strip	1,601
DFT.028-2	Electric Defrost Kit (Low Amps)	SRN: 1500-2200 (230V); ZRN: 1000-1400M6 (230V)	Includes (1) electric defrost timer, (1 or 2) heater & (1) fan contactors, terminal strip	2,354
DFT.029-1	Electric Defrost Kit (High Amps)	SRN: 0150H2B, 0199M6B, 0300-0601, 0750-1000 (460V); ZRN: 0750L6 (230V), 0650-0860M6/L6 (460V)	Includes (1) electric defrost timer, (1 or 2) heater & (1) fan contactors, terminal strip	1,601
DFT.029-2	Electric Defrost Kit (High Amps)	SRN: 0750-1000 (230V), 1500-2200; ZRN: M6 (230V), 1000-1500L6 (230V), 1000-1400M6 (460V)	Includes (1) electric defrost timer, (1 or 2) heater & (1) fan contactors, terminal strip	2,354
DEF.067-1	Fuses for electric defrost kits (Low Amps)	SRN: 0075-1000; ZRN: 0560-0860M6, 0750-1500L6	-	661
DEF.067-2	Fuses for electric defrost kits (Low Amps)	SRN: 1500-2200; ZRN: 1000-1400M6	-	936
DEF.068-1	Fuses for electric defrost kits (High Amps)	SRN: 0150H2B, 0199M6B, 0300-0601; ZRN: 0750L6	-	661
DEF.068-2	Fuses for electric defrost kits (High Amps)	SRN: 0750-2200; ZRN: 0650-1400M6, 1000-1500L6	-	936
SDK.001	InterLink™ Smart Defrost Kit™	All	Can not be used alone. Must also select a electric defrost timer or electric defrost kit.	1,408



SHIPPED-LOOSE ACCESSORIES

A wide range of shipped-loose accessories are available to order. Can't Find Something? Other options and accessories might be available on a custom order basis. Please contact your local Sales Representative or Account Engineer for assistance.

Part Number	Description	Models Used On	Notes	List Price (\$US)
Mechanical Options				
50055901	Two Tier Rack (Small)	0075 - 1000, 020 - 060	-	5,652
50055902	Two Tier Rack (Large)	1500 - 2200	-	5,652

Crankcase Pressure Regulator (CPR) Valves

A selection program must be used to pick the proper valve. The selection program requires the following inputs: system capacity, suction temperature, and maximum holding temperature. Should not be used with MOP type expansion valves in unit coolers. Please contact your local Sales Representative or Account Engineer for assistance.

Size	Part Number	List Price (\$US)
5/8"	2930142	522
7/8"	29346101	715
1 1/8"	29399012	1,053
1 3/8"	29394306	4,009
1 5/8"	4262Q	5,626



PRO³ PACKAGED REFRIGERATION SYSTEM

NOMENCLATURE

DESIGN ORIENTATION T = Top Mount	TEMPERATURE RANGE M = Medium L = Low	APPLICATION LOCATION N = Indoor T = Outdoor	EVAPORATOR MOTOR M = 2 Speed EC E = Fixed Speed EC	REVISION					
P	T	0097	M	A	T	A	M	C	A
PRODUCT LINE P = Pro ³ Packaged Refrigeration System	BTU CAPACITY 0024 = 2,400 0027 = 2,700 0028 = 2,800 0032 = 3,200 0036 = 3,600 0042 = 4,200 0046 = 4,600 0062 = 6,200 0068 = 6,800 0069 = 6,900 0078 = 7,800 0097 = 9,700 0115 = 11,500	VOLTAGE A = 115/1/60 B = 208-230/1/60 C = 230/3/60	DEFROST A = Air E = Electric	PACKAGING C = Crate S = Standard					

The **PRO³** Top Mount packaged refrigeration system combines evaporator and condensing unit into one unit expediting installation time and reducing refrigerant charge — saving time, money and energy.

This packaged system is designed to maximize storage space inside walk-in coolers or freezers and is ideal for small- to medium-sized restaurant and convenience store applications.

System is fully-assembled, evacuated, charged, run-tested and wired at the factory. No additional components are required.



FEATURES & BENEFITS

AESTHETICS

- Stucco-aluminum finish

PERFORMANCE

- Maximum vertical storage capacity
- Ideal for holding temperature
- Medium-temp air and electric defrost
- Low-temp electric defrost

ENVIRONMENTALLY FRIENDLY

- Pre-charged with R-513A (P1 cabinet) & R-448A (P2 & P3 cabinet) refrigerant to meet CARB & US Climate Alliance requirements

RELIABLE | DURABLE

- Liquid-line filter drier (Medium and large cabinet only)
- Two-year parts warranty

ENERGY EFFICIENCY

- P1 units use single speed EC Evaporator motors
- P2 & P3 units use 2 speed EC Evaporator motors
- P2 & P3 units use single speed EC Condenser motors (except PT0046M uses PSC)
- P2 & P3 units use a Microchannel condenser for higher efficiency & corrosion protection

EASE OF INSTALLATION

- Pre-charged with refrigerant
- No refrigerant piping required
- Evaporative condensate pan (indoor units only)
- All units get a removable top panel with latches
- All P1 & select P2 & P3 units come with a power cord

CONTROLS

- Microprocessor control

OUTSTANDING FEATURES

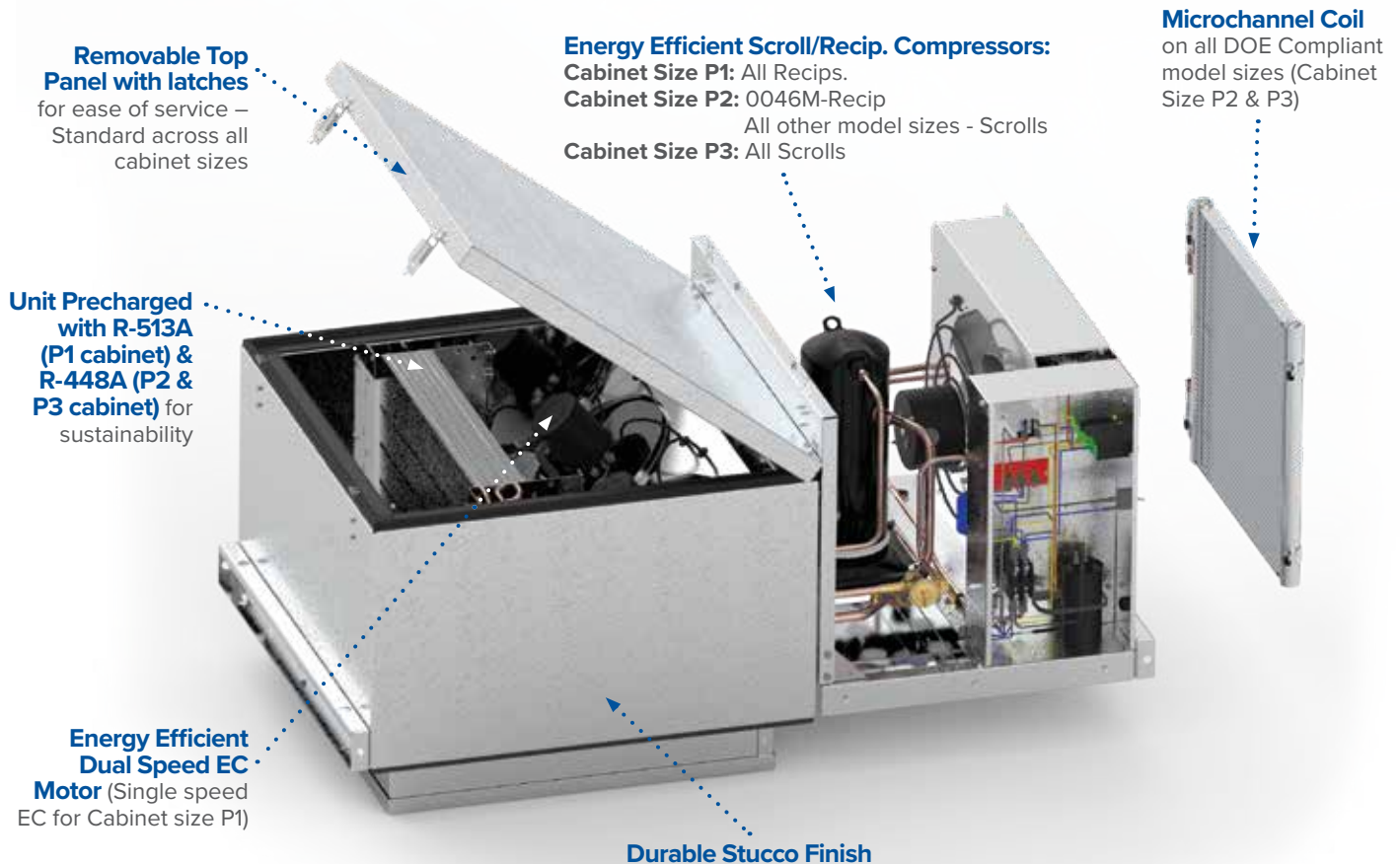



STANDARD MODEL PRICING

Medium Temperature - Air Defrost - Cooler Applications (R-513A)							
PT0024MANAESB	10,533	Indoor	115/1/60	EC Motor	YES	5-20R	P1
PT0028MANAESB	11,574	Indoor	115/1/60	EC Motor	YES	5-20R	P1
PT0032MANAESB	11,997	Indoor	115/1/60	EC Motor	YES	5-20R	P1
Medium Temperature - Air Defrost - Cooler Applications (R-448A)							
PT0046MANAMCA	16,350	Indoor	115/1/60	2 Speed EC	YES	5-20R	P2
PT0046MANAMSA	15,434	Indoor	115/1/60	2 Speed EC	YES	5-20R	P2
PT0046MBNAMCA	16,364	Indoor	208-230/1/60	2 Speed EC	YES	6-15R	P2
PT0046MBNAMSA	15,448	Indoor	208-230/1/60	2 Speed EC	YES	6-15R	P2
PT0068MBNAMCA	18,574	Indoor	208-230/1/60	2 Speed EC	YES	6-15R	P2
PT0068MBNAMSA	17,656	Indoor	208-230/1/60	2 Speed EC	YES	6-15R	P2
PT0078MBNAMCA	20,061	Indoor	208-230/1/60	2 Speed EC	YES	6-15R	P2
PT0078MBNAMSA	19,145	Indoor	208-230/1/60	2 Speed EC	YES	6-15R	P2
PT0097MBNAMCA	23,386	Indoor	208-230/1/60	2 Speed EC	YES	6-20R	P3
PT0097MBNAMSA	22,468	Indoor	208-230/1/60	2 Speed EC	YES	6-20R	P3
PT0097MCNAMCA	23,396	Indoor	208-230/3/60	2 Speed EC	NO	—	P3
PT0097MCNAMSA	22,480	Indoor	208-230/3/60	2 Speed EC	NO	—	P3
PT0115MBNAMCA	26,105	Indoor	208-230/1/60	2 Speed EC	YES	6-20R	P3
PT0115MBNAMSA	25,190	Indoor	208-230/1/60	2 Speed EC	YES	6-20R	P3
PT0115MCNAMSA	25,203	Indoor	208-230/3/60	2 Speed EC	NO	—	P3
PT0068MBTAMSA	19,452	Outdoor	208-230/1/60	2 Speed EC	NO	—	P2
PT0078MBTAMSA	20,847	Outdoor	208-230/1/60	2 Speed EC	NO	—	P2
PT0097MBTAMSA	23,472	Outdoor	208-230/1/60	2 Speed EC	NO	—	P3
PT0097MCTAMSA	23,550	Outdoor	208-230/3/60	2 Speed EC	NO	—	P3
PT0115MBTAMSA	25,737	Outdoor	208-230/1/60	2 Speed EC	NO	—	P3



STANDARD MODELS PRICING

Medium Temperature - Electric Defrost - Cooler Applications (R-513A)							
PT0024MANEESB	10,686	Indoor	115/1/60	EC Motor	YES	5-20R	P1
PT0028MANEESB	11,734	Indoor	115/1/60	EC Motor	YES	5-20R	P1
PT0032MANEESB	12,346	Indoor	115/1/60	EC Motor	YES	5-20R	P1
Medium Temperature - Electric Defrost - Cooler Applications (R-448A)							
PT0046MANEMCA	16,682	Indoor	115/1/60	2 Speed EC	YES	5-20R	P2
PT0046MANEMSA	15,765	Indoor	115/1/60	2 Speed EC	YES	5-20R	P2
PT0046MBNEMCA	17,510	Indoor	208-230/1/60	2 Speed EC	YES	6-15R	P2
PT0046MBNEMSA	16,592	Indoor	208-230/3/60	2 Speed EC	YES	6-15R	P2
PT0068MBNEMCA	18,826	Indoor	208-230/1/60	2 Speed EC	YES	6-15R	P2
PT0068MBNEMSA	17,911	Indoor	208-230/1/60	2 Speed EC	YES	6-15R	P2
PT0078MBNEMCA	20,311	Indoor	208-230/1/60	2 Speed EC	YES	6-15R	P2
PT0078MBNEMSA	19,393	Indoor	208-230/1/60	2 Speed EC	YES	6-15R	P2
PT0097MBNEMCA	24,149	Indoor	208-230/1/60	2 Speed EC	YES	6-20R	P3
PT0097MBNEMSA	23,233	Indoor	208-230/1/60	2 Speed EC	YES	6-20R	P3
PT0097MCNEMCA	24,220	Indoor	208-230/3/60	2 Speed EC	NO	—	P3
PT0097MCNEMSA	23,303	Indoor	208-230/3/60	2 Speed EC	NO	—	P3
PT0115MBNEMCA	27,006	Indoor	208-230/3/60	2 Speed EC	NO	—	P3
PT0115MBNEMSA	26,088	Indoor	208-230/3/60	2 Speed EC	NO	—	P3
PT0115MCNEMCA	27,084	Indoor	208-230/3/60	2 Speed EC	NO	—	P3
PT0115MCNEMSA	26,167	Indoor	208-230/3/60	2 Speed EC	NO	—	P3
PT0068MBTEMCA	19,994	Outdoor	208-230/1/60	2 Speed EC	NO	—	P2
PT0078MBTEMCA	21,044	Outdoor	208-230/1/60	2 Speed EC	NO	—	P2
PT0097MBTEMCA	23,946	Outdoor	208-230/1/60	2 Speed EC	NO	—	P3
PT0097MCTEMCA	24,028	Outdoor	208-230/3/60	2 Speed EC	NO	—	P3
PT0115MBTEMCA	26,246	Outdoor	208-230/1/60	2 Speed EC	NO	—	P3



STANDARD MODELS PRICING

Low Temperature - Electric Defrost - Freezer Applications (R-448A)

Low Temperature - Electric Defrost - Freezer Applications (R-448A)							
PT0027LBNEMCA	21,684	Indoor	208-230/1/60	2 Speed EC	YES	6-15R	P2
PT0027LBNEMSA	20,742	Indoor	208-230/1/60	2 Speed EC	YES	6-15R	P2
PT0036LBNEMCA	24,556	Indoor	208-230/1/60	2 Speed EC	YES	6-15R	P2
PT0036LBNEMSA	23,616	Indoor	208-230/1/60	2 Speed EC	YES	6-15R	P2
PT0042LBNEMCA	27,102	Indoor	208-230/1/60	2 Speed EC	YES	6-20R	P2
PT0042LBNEMSA	26,188	Indoor	208-230/1/60	2 Speed EC	YES	6-20R	P2
PT0062LBNEMCA	30,860	Indoor	208-230/1/60	2 Speed EC	NO	—	P3
PT0062LBNEMSA	29,942	Indoor	208-230/1/60	2 Speed EC	NO	—	P3
PT0062LCNEMCA	30,880	Indoor	208-230/3/60	2 Speed EC	NO	—	P3
PT0062LCNEMSA	29,965	Indoor	208-230/3/60	2 Speed EC	NO	—	P3
PT0069LBNEMCA	32,889	Indoor	208-230/1/60	2 Speed EC	NO	—	P3
PT0069LBNEMSA	31,972	Indoor	208-230/1/60	2 Speed EC	NO	—	P3
PT0069LCNEMCA	32,935	Indoor	208-230/3/60	2 Speed EC	NO	—	P3
PT0069LCNEMSA	32,020	Indoor	208-230/3/60	2 Speed EC	NO	—	P3
PT0027LBTEMCA	23,409	Outdoor	208-230/1/60	2 Speed EC	NO	—	P2
PT0036LBTEMCA	26,586	Outdoor	208-230/1/60	2 Speed EC	NO	—	P2
PT0042LBTEMCA	29,500	Outdoor	208-230/1/60	2 Speed EC	NO	—	P2
PT0062LBTEMCA	33,576	Outdoor	208-230/1/60	2 Speed EC	NO	—	P3
PT0062LCTEMCA	33,606	Outdoor	208-230/3/60	2 Speed EC	NO	—	P3
PT0069LBTEMCA	35,876	Outdoor	208-230/1/60	2 Speed EC	NO	—	P3
PT0069LCTEMCA	35,922	Outdoor	208-230/3/60	2 Speed EC	NO	—	P3



AIR-COOLED CONDENSERS

1 - 26 Ton

Direct drive air-cooled condensers, available from 1 through 26 ton models, are the industry standard for remote air-cooled applications. They are designed for efficient performance and low maintenance and are great for many applications.

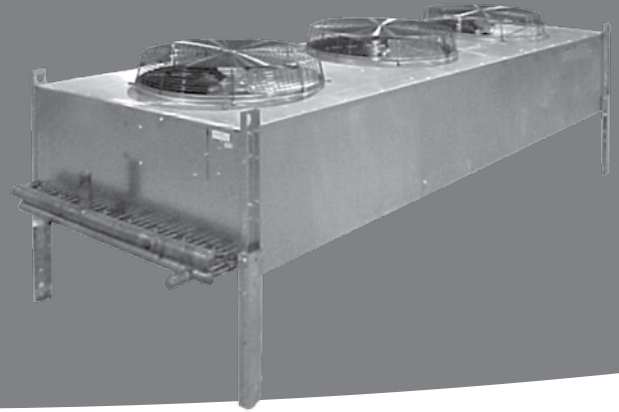

NOMENCLATURE



FCB	026
Product Line	Size
Direct Drive Air-Cooled Condenser	Model

OVERVIEW

STANDARD FEATURES

Ease of Installation & Service

- Weatherproof junction box with motor leads terminating for single-point field wiring

Reliable & Durable

- Heavy gauge smooth aluminum cabinet for long life and attractive appearance
- Coated steel fan guards
- Internally protected, permanently lubricated ball bearing motors with automatic reset

Performance

- Fully baffled fan sections to provide structural strength and prevent fan windmilling in the off cycle
- PSC motors come standard to help save on energy costs

Versatile

- Horizontal or vertical air discharge
- Multicircuiting at no additional charge



CONFIGURABLE MODELS & OPTIONS PRICING

Configurable Models, Factory-Installed Options & List Prices

- Specify model motor voltage and type at time of order. 208-230/1/60 motors may be field converted to 230/3/60 power.
- Variable speed motor is on the header fan only; All other motors in a 1x2 or 1x3 are fixed speed motors that cycle on or off as needed. Must have variable speed controller (customer supplied or select factory-installed option).

Ambient fan cycling is included in the factory-installed variable speed controller package.

- Standard Control Circuit Voltage is 230V unless otherwise specified. 24V & 115V are available at no additional cost. Specify control circuit voltage when ordering.
- Fan cycling pricing does not include control circuit transformer for 460V or 575V units. If needed, transformer can be ordered from ship-loose accessories.

Larkin Config Model	List Price (\$US)	Factory-Installed Options List Price Adders (\$US)								
		Fan Cycling Options				Electrical Options			Coil Coatings	
		1 PH Amb.	3 PH Amb.	1 PH Press.	3 PH Press.	Ind. Motor Fuses	Sealtite Wiring	Var Sp Controller	ProKote™ Coated Fins	Bronz-Glow Coating or ElectroFin Coil
208-230/1/60 with PSC Motors										
FCB1	3,503	-	-	-	-	-	1,209	-	331	4,612
FCB1.5	4,290	-	-	-	-	-	1,209	-	343	4,612
FCB2	4,604	-	-	-	-	-	1,209	-	369	4,612
FCB3	5,139	-	-	-	-	-	1,209	-	454	4,612
FCB5	9,369	-	-	-	-	1,248	1,209	-	553	4,612
FCB8	11,833	-	-	-	-	1,248	1,209	-	880	4,612
FCB10	14,463	850	-	1,549	-	1,630	2,151	-	992	6,904
FCB12	16,240	850	-	1,549	-	1,630	2,151	-	1,094	6,904
FCB14	18,574	850	-	1,549	-	1,630	2,151	-	1,321	9,208
FCB16	20,358	850	-	1,549	-	1,630	2,151	-	1,618	10,551
FCB21	23,471	1,181	-	1,955	-	2,022	2,221	-	1,795	13,813
FCB23	24,133	1,181	-	1,955	-	2,022	2,221	-	2,044	13,813
FCB26	26,352	1,181	-	1,955	-	2,022	2,221	-	2,319	13,813
208-230/1/60 with Variable Speed Motor										
FCB5SM	10,090	-	-	Call	-	1,248	1,209	3,701	553	4,612
FCB8SM	12,558	-	-	Call	-	1,248	1,209	3,701	880	4,612
FCB10SM	15,184	-	-	Call	-	-	2,151	3,701	992	6,904
FCB12SM	16,964	-	-	Call	-	-	2,151	3,701	1,094	6,904
FCB14SM	19,299	-	-	Call	-	-	2,151	3,701	1,321	9,208
FCB16SM	21,082	-	-	Call	-	-	2,151	3,701	1,618	10,551
FCB21SM	24,197	-	-	Call	-	-	2,221	3,701	1,795	13,813
FCB23SM	24,860	-	-	Call	-	-	2,221	3,701	2,044	13,813
FCB26SM	27,080	-	-	Call	-	-	2,221	3,701	2,319	13,813

Notes:

- For selection or sizing assistance, use Heatcraft software tool, THE HUB or contact your local your Sales Representative or Account Engineer.
- Copper Fin Coils are available. Contact your Sales Representative or Account Engineer for more information.



CONFIGURABLE MODELS & OPTIONS PRICING

Configurable Models, Factory-Installed Options & List Prices

- Specify model motor voltage and type at time of order. 208-230/1/60 motors may be field converted to 230/3/60 power.
- Variable speed motor is on the header fan only; All other motors in a 1x2 or 1x3 are fixed speed motors that cycle on or off as needed. Must have variable speed controller (customer supplied or select factory-installed option).
- Ambient fan cycling is included in the factory-installed variable speed controller package.
- Standard Control Circuit Voltage is 230V unless otherwise specified. 24V & 115V are available at no additional cost. Specify control circuit voltage when ordering.
- Fan cycling pricing does not include control circuit transformer for 460V or 575V units. If needed, transformer can be ordered from ship-loose accessories.

Larkin Config Model	List Price (\$US)	Factory-Installed Options List Price Adders (\$US)								
		Fan Cycling Options				Electrical Options			Coil Coatings	
		1 PH Amb.	3 PH Amb.	1 PH Press.	3 PH Press.	Ind. Motor Fuses	Sealtite Wiring	Var Sp Controller	ProKote™ Coated Fins	Bronz-Glow Coating or ElectroFin Coil
208-230/3/60 with Polyphase Motors										
FCB5	9,923	-	-	-	-	1,248	1,209	-	553	4,612
FCB8	12,265	-	-	-	-	1,248	1,209	-	880	4,612
FCB10	15,519	-	2,136	-	2,838	1,630	2,151	-	992	6,904
FCB12	17,110	-	2,136	-	2,838	1,630	2,151	-	1,094	6,904
FCB14	19,442	-	2,136	-	2,838	1,630	2,151	-	1,321	9,208
FCB16	21,228	-	2,136	-	2,838	1,630	2,151	-	1,618	10,551
FCB21	24,786	-	2,638	-	3,419	2,022	2,221	-	1,795	13,813
FCB23	25,445	-	2,638	-	3,419	2,022	2,221	-	2,044	13,813
FCB26	27,659	-	2,638	-	3,419	2,022	2,221	-	2,319	13,813
208-230/3/60 with Variable Speed Motor										
FCB10SM	16,241	-	-	-	Call	1,630	2,151	3,701	992	6,904
FCB12SM	17,832	-	-	-	Call	1,630	2,151	3,701	1,094	6,904
FCB14SM	20,166	-	-	-	Call	1,630	2,151	3,701	1,321	9,208
FCB16SM	21,951	-	-	-	Call	1,630	2,151	3,701	1,618	10,551
FCB21SM	25,512	-	-	-	Call	2,022	2,221	3,701	1,795	13,813
FCB23SM	26,170	-	-	-	Call	2,022	2,221	3,701	2,044	13,813
FCB26SM	28,384	-	-	-	Call	2,022	2,221	3,701	2,319	13,813
460/3/60 with Polyphase Motors										
FCB5	9,923	-	-	-	-	1,248	1,209	-	553	4,612
FCB8	12,265	-	-	-	-	1,248	1,209	-	880	4,612
FCB10	15,519	-	2,136	-	2,838	1,630	2,151	-	992	6,904
FCB12	17,110	-	2,136	-	2,838	1,630	2,151	-	1,094	6,904
FCB14	19,442	-	2,136	-	2,838	1,630	2,151	-	1,321	9,208
FCB16	21,228	-	2,136	-	2,838	1,630	2,151	-	1,618	10,551
FCB21	24,786	-	2,638	-	3,419	2,022	2,221	-	1,795	13,813
FCB23	25,445	-	2,638	-	3,419	2,022	2,221	-	2,044	13,813
FCB26	27,659	-	2,638	-	3,419	2,022	2,221	-	2,319	13,813
460/3/60 with Variable Speed Motor										
FCB10SM	16,241	-	-	-	Call	1,630	2,151	3,701	992	6,904
FCB12SM	17,832	-	-	-	Call	1,630	2,151	3,701	1,094	6,904
FCB14SM	20,166	-	-	-	Call	1,630	2,151	3,701	1,321	9,208
FCB16SM	21,951	-	-	-	Call	1,630	2,151	3,701	1,618	10,551
FCB21SM	25,512	-	-	-	Call	2,022	2,221	3,701	1,795	13,813
FCB23SM	26,170	-	-	-	Call	2,022	2,221	3,701	2,044	13,813
FCB26SM	28,384	-	-	-	Call	2,022	2,221	3,701	2,319	13,813

Notes:

- For selection or sizing assistance, use Heatcraft software tool, THE HUB or contact your local your Sales Representative or Account Engineer.
- Copper Fin Coils are available. Contact your Sales Representative or Account Engineer for more information.



CONFIGURABLE MODELS & OPTIONS PRICING

Configurable Models, Factory-Installed Options & List Prices

- Specify model motor voltage and type at time of order. 208-230/1/60 motors may be field converted to 230/3/60 power.
 - Variable speed motor is on the header fan only; All other motors in a 1x2 or 1x3 are fixed speed motors that cycle on or off as needed. Must have variable speed controller (customer supplied or select factory-installed option).
- Ambient fan cycling is included in the factory-installed variable speed controller package.
- Standard Control Circuit Voltage is 230V unless otherwise specified. 24V & 115V are available at no additional cost. Specify control circuit voltage when ordering.
 - Fan cycling pricing does not include control circuit transformer for 460V or 575V units. If needed, transformer can be ordered from ship-loose accessories.

Larkin Config Model	List Price (\$US)	Factory-Installed Options List Price Adders (\$US)								
		Fan Cycling Options				Electrical Options			Coil Coatings	
		1 PH Amb.	3 PH Amb.	1 PH Press.	3 PH Press.	Ind. Motor Fuses	Sealtite Wiring	Var Sp Controller	ProKote™ Coated Fins	Bronz-Glow Coating or ElectroFin Coil
575/3/60 with Polyphase Motors										
FCB5	10,570	-	-	-	-	-	1,209	-	553	4,612
FCB8	12,909	-	-	-	-	-	1,209	-	880	4,612
FCB10	16,807	-	2,136	-	2,838	1,630	2,151	-	992	6,904
FCB12	18,401	-	2,136	-	2,838	1,630	2,151	-	1,094	6,904
FCB14	20,733	-	2,136	-	2,838	1,630	2,151	-	1,321	9,208
FCB16	22,516	-	2,136	-	2,838	1,630	2,151	-	1,618	10,551
FCB21	26,723	-	2,638	-	3,419	2,022	2,221	-	1,795	13,813
FCB23	27,378	-	2,638	-	3,419	2,022	2,221	-	2,044	13,813

Notes:

- For selection or sizing assistance, use Heatcraft software tool, THE HUB or contact your local your Sales Representative or Account Engineer.
- Copper Fin Coils are available. Contact your Sales Representative or Account Engineer for more information.

SHIPPED-LOOSE ACCESSORIES

Can't Find An Option or Accessory?

Other options and accessories might be available on a custom order basis. Please contact your local Sales Representative or Account Engineer for assistance.

Part Number	Description	Models Used On	List Price (\$US)	Notes
8980700-1	Discharge Air Gravity Damper	1x1	2,166	Includes 1 damper per fan cell
8980700-2	Discharge Air Gravity Dampers	1x2	4,330	Includes 1 damper per fan cell
8980700-3	Discharge Air Gravity Dampers	1x3	6,497	Includes 1 damper per fan cell
R038253919	Control Circuit Transformer	ALL	982	-



AIR-COOLED CONDENSERS

11 - 264 Ton

Product Description

These air-cooled condensers feature improved energy efficiency and low sound levels sought after by the supermarket and grocery industry. Traditional condensers using 1140 RPM motors offer high capacities, but cannot meet the low sound and energy efficiency standards demanded today by this industry. High capacities for operation along with the low sound and energy efficiency requirements are brought together in these units for a great fit for many applications.



NOMENCLATURE

L	N	H	S	04	A	050
Brand	Vintage	Model	Width	Fans	Model Identifier	Standard Capacity
L = Larkin		H = 1140 RPM, 1.5 HP L = 830 RPM, 1.5 HP X = 830 RPM, 1.0 HP Q = 540 RPM, 0.5 HP E = Venturi-Mount VSEC Motor K = Rail-Mount VSEC Motor, 1140 RPM J = Rail-Mount VSEC Motor, 830 RPM	S = Single D = Double	# of Fans (01 - 14)		(MBH/°TD, R-22 @ 10 FPI)

OVERVIEW

STANDARD FEATURES

- 10 fins per inch spacing standard. 8, 12, and 14 fins per inch spacing available as an option.
- Floating Tube™ coil design virtually eliminates tube sheet leaks
- Internal baffles provided between all fan cells
- Condensers up to 3 fans in length use 3/8" diameter tube to minimize refrigerant charge. Condensers 4 or more fans in length use 1/2" diameter tube to minimize refrigerant pressure drop
- Coated steel fan guards
- Weather resistant control panel with factory-mounted door interrupt disconnect switch
- 2-year warranty on product and 5-year warranty on Floating Tube™

Models with Rail-Mount Variable Speed EC Motors (VSEC)

- 830 or 1140 RPM maximum speeds, with capacities matching 830 or 1140 RPM fixed speed motor options
- 830 RPM Rail Mounted option meets California Title 24 energy efficiency standard

Models with Venturi-Mount Variable Speed EC Motors (VSEC)

- EC motor, swept fan blade and venturi incorporating integrated variable speed technology
- Broad capacity range from 16 to 264 tons
- Aluminum housing for an attractive appearance and corrosion protection, with painted galvanized steel, or galvanized steel as an option

- Side access panels for ease of cleaning coils
- 3-year warranty on EC motors

Models with 830 or 540 RPM Fixed Speed Motors

- Direct drive fan motors in 830 or 540 RPM
- The patented QuietEdge™ fan blade provides an unprecedented sound level of 49.6 dBA (540 RPM @ 10 ft.)
- Patented ServiceEase™ motor mount feature, allows for ease of motor service and reduces likelihood of damage to the coils during servicing
- Condenser coils incorporate the latest advancements in coil technology to provide maximum capacity
- Broader product range to address all applications — capacities ranging from 11 to 225 nominal tons
- Galvanized steel housing
- High efficiency, three-phase fan motors with ball bearings and internal overload protection

Models with 1140 RPM Fixed Speed Motors

- Direct drive fan motors
- Patented ServiceEase™ motor mount
- New, high efficiency condenser coil designed for optimum performance
- Expanded product range from 15 to 249 nominal tons
- Galvanized steel housing
- High efficiency, three-phase fan motors with ball bearings and internal overload protection



CONFIGURABLE MODELS PRICING

Need to customize?

- Look on page ACC-12 for factory-installed fan cycling, electrical, and mechanical options.
- Look on page ACC-16 for condenser fin and coil protection options.

Configurable Models, Motor Voltages, & List Prices

Specify model motor voltage at time of order

Larkin Config Model	List Price by Motor Voltage (\$US)			Fan Config.	Notes
	208-230/3/60	460/3/60	575/3/60		
Models with VSEC Motors					
LNES01A008	28,304	28,304	-	1x1	-
LNES01A009	31,341	31,341	-	1x1	-
LNES02A011	48,460	48,460	-	1x2	-
LNES02A015	55,554	55,554	-	1x2	-
LNES02A018	60,751	60,751	-	1x2	-
LNES03A023	83,409	83,409	-	1x3	-
LNES03A027	91,225	91,225	-	1x3	-
LNES04A031	112,641	112,641	-	1x4	-
LNES04A036	121,625	121,625	-	1x4	-
LNES05A039	140,501	140,501	-	1x5	-
LNES05A047	154,574	154,574	-	1x5	-
LNES06A056	185,487	185,487	-	1x6	-
LNES07A065	216,029	216,029	-	1x7	-
LNED04A023	95,500	95,500	-	2x2	-
LNED04A031	111,219	111,219	-	2x2	-
LNED04A036	121,625	121,625	-	2x2	-
LNED06A046	166,797	166,797	-	2x3	-
LNED06A054	182,429	182,429	-	2x3	-
LNED08A062	223,021	223,021	-	2x4	Model has oversized electrical box.
LNED08A073	243,879	243,879	-	2x4	Model has oversized electrical box.
LNED10A079	281,522	281,522	-	2x5	Model has oversized electrical box.
LNED10A093	309,724	309,724	-	2x5	Model has oversized electrical box.
LNED12A112	371,574	371,574	-	2x6	Model has oversized electrical box.
LNED14A129	432,665	432,665	-	2x7	Model has oversized electrical box.
<001>Models with 540 RPM (0.5HP) Motors					
LNQS01A005	12,998	12,998	-	1x1	-
LNQS01A006	15,567	15,567	-	1x1	-
LNQS02A008	21,503	21,503	-	1x2	-
LNQS02A010	28,831	28,831	-	1x2	-
LNQS02A011	32,354	32,354	-	1x2	-

Notes:

For sizing and selection assistance, use Heatcraft software tool, THE HUB or contact your local Sales Representative or Account Engineer.



CONFIGURABLE MODELS PRICING

Need to customize?

- Look on page ACC-12 for factory-installed fan cycling, electrical, and mechanical options.
- Look on page ACC-16 for condenser fin and coil protection options.

Configurable Models, Motor Voltages, & List Prices

Specify model motor voltage at time of order

Larkin Config Model	List Price by Motor Voltage (\$US)			Fan Config.	Notes
	208-230/3/60	460/3/60	575/3/60		
LNQS03A016	45,011	45,011	-	1x3	-
LNQS03A017	50,095	50,095	-	1x3	-
LNQS04A021	60,950	60,950	-	1x4	-
LNQS04A023	67,736	67,736	-	1x4	-
LNQS05A026	76,990	76,990	-	1x5	-
LNQS05A029	85,471	85,471	-	1x5	-
LNQS06A034	103,244	103,244	-	1x6	-
LNQS07A042	125,536	125,536	-	1x7	-
LNQD04A016	46,262	46,262	-	2x2	-
LNQD04A021	60,950	60,950	-	2x2	-
LNQD04A023	67,736	67,736	-	2x2	-
LNQD06A031	92,933	92,933	-	2x3	-
LNQD06A034	103,244	103,244	-	2x3	-
LNQD08A041	125,614	125,614	-	2x4	Model has oversized electrical box.
LNQD08A046	139,283	139,283	-	2x4	Model has oversized electrical box.
LNQD10A052	157,733	157,733	-	2x5	Model has oversized electrical box.
LNQD10A057	174,791	174,791	-	2x5	Model has oversized electrical box.
LNQD12A069	210,170	210,170	-	2x6	Model has oversized electrical box.
LNQD14A083	254,789	254,789	-	2x7	Model has oversized electrical box.
Models with 830 RPM (1.0HP) Motors					
LNXS01A006	13,062	13,062	-	1x1	-
LNXS01A008	15,804	15,804	-	1x1	-
LNXS02A010	21,177	21,177	-	1x2	-
LNXS02A013	28,992	28,992	-	1x2	-
LNXS02A015	33,728	33,728	-	1x2	-
LNXS03A020	44,519	44,519	-	1x3	-
LNXS03A023	51,658	51,658	-	1x3	-
LNXS04A026	60,046	60,046	-	1x4	-
LNXS04A030	69,520	69,520	-	1x4	-
LNXS05A033	75,525	75,525	-	1x5	-
LNXS05A038	87,374	87,374	-	1x5	-

Notes:

For sizing and selection assistance, use Heatcraft software tool, THE HUB or contact your local Sales Representative or Account Engineer.



CONFIGURABLE MODELS PRICING

Need to customize?

- Look on page ACC-12 for factory-installed fan cycling, electrical, and mechanical options.
- Look on page ACC-16 for condenser fin and coil protection options.

Configurable Models, Motor Voltages, & List Prices

Specify model motor voltage at time of order

Larkin Config Model	List Price by Motor Voltage (\$US)			Fan Config.	Notes
	208-230/3/60	460/3/60	575/3/60		
LNXS06A045	105,334	105,334	-	1x6	-
LNXS07A052	120,934	120,934	-	1x7	-
LNXD04A020	44,310	44,310	-	2x2	-
LNXD04A026	60,023	60,023	-	2x2	-
LNXD04A030	69,546	69,546	-	2x2	-
LNXD06A039	91,024	91,024	-	2x3	-
LNXD06A045	105,305	105,305	-	2x3	-
LNXD08A052	122,581	122,581	-	2x4	Model has oversized electrical box.
LNXD08A061	141,632	141,632	-	2x4	Model has oversized electrical box.
LNXD10A066	153,588	153,588	-	2x5	Model has oversized electrical box.
LNXD10A076	177,401	177,401	-	2x5	Model has oversized electrical box.
LNXD12A091	213,162	213,162	-	2x6	Model has oversized electrical box.
LNXD14A104	244,409	244,409	-	2x7	Model has oversized electrical box.
Models with 830 RPM (1.5HP) Motors					
LNLS01A007	14,583	14,583	14,950	1x1	-
LNLS01A008	17,243	17,243	17,610	1x1	-
LNLS02A010	21,867	21,867	22,601	1x2	-
LNLS02A014	30,062	30,062	30,796	1x2	-
LNLS02A016	34,855	34,855	35,589	1x2	-
LNLS03A021	45,103	45,103	46,204	1x3	-
LNLS03A024	52,328	52,328	53,429	1x3	-
LNLS04A028	60,046	60,046	61,514	1x4	-
LNLS04A032	69,727	69,727	71,195	1x4	-
LNLS05A035	76,504	76,504	78,339	1x5	-
LNLS05A042	89,729	89,729	91,564	1x5	-
LNLS06A050	107,574	107,574	109,776	1x6	-
LNLS07A055	118,641	118,641	121,210	1x7	-
LNLD04A020	43,684	43,684	45,152	2x2	-
LNLD04A028	60,047	60,047	61,515	2x2	-
LNLD04A032	69,727	69,727	71,195	2x2	-
LNLD06A042	90,100	90,100	92,302	2x3	-

Notes:

For sizing and selection assistance, use Heatcraft software tool, THE HUB or contact your local Sales Representative or Account Engineer.



CONFIGURABLE MODELS PRICING

Need to customize?

- Look on page ACC-12 for factory-installed fan cycling, electrical, and mechanical options.
- Look on page ACC-16 for condenser fin and coil protection options.

Configurable Models, Motor Voltages, & List Prices

Specify model motor voltage at time of order

Larkin Config Model	List Price by Motor Voltage (\$US)			Fan Config.	Notes
	208-230/3/60	460/3/60	575/3/60		
LNLD06A048	104,504	104,504	106,706	2x3	-
LNLD08A056	120,645	120,645	123,581	2x4	Model has oversized electrical box.
LNLD08A065	139,940	139,940	142,876	2x4	Model has oversized electrical box.
LNLD10A071	153,467	153,467	157,137	2x5	Model has oversized electrical box.
LNLD10A083	179,839	179,839	183,509	2x5	Model has oversized electrical box.
LNLD12A100	215,656	215,656	220,060	2x6	Model has oversized electrical box.
LNLD14A110	237,763	237,763	242,901	2x7	Model has oversized electrical box.
Models with 1140 RPM (1.5HP) Motors					
LNHS01A007	14,871	14,871	15,238	1x1	-
LNHS01A009	17,821	17,821	18,188	1x1	-
LNHS02A011	21,834	21,834	22,568	1x2	-
LNHS02A015	28,722	28,722	29,456	1x2	-
LNHS02A017	33,772	33,772	34,506	1x2	-
LNHS03A022	43,155	43,155	44,256	1x3	-
LNHS03A026	50,749	50,749	51,850	1x3	-
LNHS04A029	58,928	58,928	60,396	1x4	-
LNHS04A034	67,658	67,658	69,126	1x4	-
LNHS05A037	73,379	73,379	75,214	1x5	-
LNHS05A044	87,038	87,038	88,873	1x5	-
LNHS06A053	104,446	104,446	106,648	1x6	-
LNHS07A061	121,494	121,494	124,063	1x7	-
LNHD04A021	42,293	42,293	43,761	2x2	-
LNHD04A029	57,554	57,554	59,022	2x2	-
LNHD04A034	67,658	67,658	69,126	2x2	-
LNHD06A044	86,300	86,300	88,502	2x3	-
LNHD06A051	101,476	101,476	103,678	2x3	-
LNHD08A058	115,697	115,697	118,633	2x4	Model has oversized electrical box.
LNHD08A068	135,941	135,941	138,877	2x4	Model has oversized electrical box.
LNHD10A074	147,281	147,281	150,951	2x5	Model has oversized electrical box.
LNHD10A088	174,659	174,659	178,329	2x5	Model has oversized electrical box.
LNHD12A106	209,495	209,495	213,899	2x6	Model has oversized electrical box.
LNHD14A122	243,586	243,586	248,724	2x7	Model has oversized electrical box.

Notes:

For sizing and selection assistance, use Heatcraft software tool, THE HUB or contact your local Sales Representative or Account Engineer.



CONFIGURABLE MODELS PRICING

Need to customize?

- Look on page ACC-12 for factory-installed fan cycling, electrical, and mechanical options.
- Look on page ACC-16 for condenser fin and coil protection options.

Configurable Models, Motor Voltages, & List Prices

Specify model motor voltage at time of order

Larkin Config Model	List Price by Motor Voltage (\$US)			Fan Config.	Notes
	208-230/3/60	460/3/60	575/3/60		
LNKS01A007	24,274	24,274	-	1x1	-
LNKS01A009	27,287	27,287	-	1x1	-
LNKS02A011	40,469	40,469	-	1x2	-
LNKS02A015	47,506	47,506	-	1x2	-
LNKS02A017	52,661	52,661	-	1x2	-
LNKS03A022	71,334	71,334	-	1x3	-
LNKS03A026	79,082	79,082	-	1x3	-
LNKS04A029	96,527	96,527	-	1x4	-
LNKS04A034	105,437	105,437	-	1x4	-
LNKS05A037	120,365	120,365	-	1x5	-
LNKS05A044	134,310	134,310	-	1x5	-
LNKS06A053	161,173	161,173	-	1x6	-
LNKS07A061	187,669	187,669	-	1x7	-
LNKD04A021	79,538	79,538	-	2x2	-
LNKD04A029	95,118	95,118	-	2x2	-
LNKD04A034	105,437	105,437	-	2x2	-
LNKD06A044	142,645	142,645	-	2x3	-
LNKD06A051	158,141	158,141	-	2x3	-
LNKD08A058	190,824	190,824	-	2x4	Model has oversized electrical box.
LNKD08A068	211,498	211,498	-	2x4	Model has oversized electrical box.
LNKD10A074	241,250	241,250	-	2x5	Model has oversized electrical box.
LNKD10A088	269,204	269,204	-	2x5	Model has oversized electrical box.
LNKD12A106	322,950	322,950	-	2x6	Model has oversized electrical box.
LNKD14A122	375,942	375,942	-	2x7	Model has oversized electrical box.
Models with Rail-Mount VSEC (830 RPM) Motors					
LNJS01A007	24,189	24,189	-	1x1	-
LNJS01A008	27,112	27,112	-	1x1	-
LNJS02A010	40,479	40,479	-	1x2	-
LNJS02A014	47,905	47,905	-	1x2	-
LNJS02A016	52,984	52,984	-	1x2	-

Notes:

For sizing and selection assistance, use Heatcraft software tool, THE HUB or contact your local Sales Representative or Account Engineer.



CONFIGURABLE MODELS PRICING

Need to customize?

- Look on page ACC-12 for factory-installed fan cycling, electrical, and mechanical options.
- Look on page ACC-16 for condenser fin and coil protection options.

Configurable Models, Motor Voltages, & List Prices

Specify model motor voltage at time of order

Larkin Config Model	List Price by Motor Voltage (\$US)			Fan Config.	Notes
	208-230/3/60	460/3/60	575/3/60		
LNJS03A021	71,915	71,915	-	1x3	-
LNJS03A024	79,555	79,555	-	1x3	-
LNJS04A028	96,863	96,863	-	1x4	-
LNJS04A032	106,055	106,055	-	1x4	-
LNJS05A035	121,302	121,302	-	1x5	-
LNJS05A042	135,118	135,118	-	1x5	-
LNJS06A050	162,113	162,113	-	1x6	-
LNJS07A055	186,815	186,815	-	1x7	-
LNJD04A020	79,955	79,955	-	2x2	-
LNJD04A028	95,871	95,871	-	2x2	-
LNJD04A032	106,055	106,055	-	2x2	-
LNJD06A042	143,787	143,787	-	2x3	-
LNJD06A048	159,052	159,052	-	2x3	-
LNJD08A056	192,308	192,308	-	2x4	Model has oversized electrical box.
LNJD08A065	212,699	212,699	-	2x4	Model has oversized electrical box.
LNJD10A071	243,107	243,107	-	2x5	Model has oversized electrical box.
LNJD10A083	270,761	270,761	-	2x5	Model has oversized electrical box.
LNJD12A100	324,801	324,801	-	2x6	Model has oversized electrical box.
LNJD14A110	374,195	374,195	-	2x7	Model has oversized electrical box.

Notes:

For sizing and selection assistance, use Heatcraft software tool, THE HUB or contact your local Sales Representative or Account Engineer.



OPTIONS PRICING - RAIL-MOUNTED VSEC MODELS

Can't find an option?

Other options and accessories might be available on a custom order basis. Please contact your local Sales Representative or Account Engineer for assistance.

Factory-Installed Fan Cycling, Electrical, and Mechanical Options

- Motors are 208-230/3/60 or 460/3/60.
- Power outlet is supplied unwired.
- Fused disconnect option is only available on units with an MOP of 60 or less. Please see accompanying technical specifications.

Option Code	Option Description	List Price Adder by Fan Configuration (US\$)													
		1x1	1x2	1x3	1x4	1x5	1x6	1x7	2x2	2x3	2x4	2x5	2x6	2x7	
Fan Cycling Options															
FC.019	Proportional Pressure Control	3,529	3,529	3,529	3,529	3,529	3,529	3,529	7,051	7,051	7,051	7,051	7,051	7,051	
Electrical Options															
DISC.002	Fused Disconnect	386	772	1,158	1,544	1,930	2,316	2,702	1,545	2,318	3,089	3,861	4,634	5,406	
MP.002	Individual Motor Fuses	386	772	1,158	1,544	1,930	2,316	2,702	1,545	2,318	3,089	3,861	4,634	5,406	
MP.004	Paired Motor Fuses	-	-	-	-	-	-	-	773	1,159	1,545	1,931	2,318	2,703	
MP.003	Individual Circuit Breakers (230V or 460V)	768	1,536	2,304	3,072	3,840	4,608	5,376	3,072	4,608	6,144	7,680	9,216	10,752	
MP.005	Paired Circuit Breakers (230V or 460V)	-	-	-	-	-	-	-	1,537	2,308	3,077	3,844	4,611	5,380	
MTB.001	Individual Motor Terminal Boards	270	540	809	1,077	1,349	1,618	1,878	1,082	1,616	2,157	2,698	3,236	3,755	
MTB.002	Paired Motor Terminal Boards	-	-	-	-	-	-	-	540	809	1,077	1,349	1,618	1,878	
PO.001	Power Outlet (115V)	538	538	538	538	538	538	538	538	538	538	538	538	538	
Mechanical Options															
CM.002	Aluminum Cabinet	427	854	1,281	1,708	2,135	2,562	2,989	1,708	2,562	3,416	4,270	5,124	5,978	
CM.003	Pre-Painted Steel Cabinet	427	854	1,281	1,708	2,135	2,562	2,989	1,708	2,562	3,416	4,270	5,124	5,978	
CM.004	Coil Access Panels, Galv	860	1,720	2,580	3,440	4,300	5,160	6,020	3,440	5,160	6,880	8,600	10,320	12,040	
CM.005	Coil Access Panels, Aluminum	860	1,720	2,580	3,440	4,300	5,160	6,020	3,440	5,160	6,880	8,600	10,320	12,040	
CM.006	Coil Access Panels, Painted Steel	860	1,720	2,580	3,440	4,300	5,160	6,020	3,440	5,160	6,880	8,600	10,320	12,040	
VEN.002	Hinged Venturi	913	1,826	2,739	3,652	4,565	5,478	6,391	3,652	5,478	7,304	9,130	10,956	12,782	
LEGS.002	Extended Legs, 30"	193	193	386	290	578	677	773	193	386	290	578	677	773	
LEGS.003	Extended Legs, 36"	193	193	386	290	578	677	773	193	386	290	578	677	773	
LEGS.004	Extended Legs, 42"	193	193	386	290	578	677	773	193	386	290	578	677	773	
LEGS.005	Unit Frame, Std. Legs, 20"	2,730	3,937	5,150	7,377	8,927	10,646	11,888	3,937	5,150	7,377	8,927	10,646	12,365	
LEGS.006	Unit Frame, Ext. Legs, 42"	2,919	4,326	5,730	8,145	9,889	11,805	13,190	4,326	5,730	8,145	9,889	11,805	13,715	
LEGS.007	Paratemp, 20"	-	98	-	486	-	-	-	98	-	486	-	-	-	
LEGS.008	Paratemp, Extended Legs, 30"	-	290	-	775	-	-	-	290	-	775	-	-	-	
LEGS.009	Paratemp, Extended Legs, 36"	-	290	-	775	-	-	-	290	-	775	-	-	-	
LEGS.010	Paratemp, Extended Legs, 42"	-	290	-	775	-	-	-	290	-	775	-	-	-	
HM.00X	Connection Manifold (shipped-loose)	-	-	-	-	-	-	-	1,982	2,577	2,629	2,896	3,006	3,326	



OPTIONS PRICING - VENTURI-MOUNTED VSEC MODELS

Can't find an option?

Other options and accessories might be available on a custom order basis. Please contact your local Sales Representative or Account Engineer for assistance.

Factory-Installed Fan Cycling, Electrical, and Mechanical Options

- Motors are 208-230/3/60 or 460/3/60.
- Power outlet is supplied unwired.
- Fused disconnect option is only available on units with an MOP of 60 or less. Please see accompanying technical specifications.

Option Code	Option Description	List Price Adder by fan Configuration (US\$)													
		1x1	1x2	1x3	1x4	1x5	1x6	1x7	2x2	2x3	2x4	2x5	2x6	2x7	
Fan Cycling Options															
FC.019	Proportional Pressure Control	3,529	3,529	3,529	3,529	3,529	3,529	3,529	3,529	7,051	7,051	7,051	7,051	7,051	7,051
Electrical Options															
DISC.002	Fused Disconnect	386	772	1,158	1,544	1,930	2,316	2,702	1,545	2,318	3,089	3,861	4,634	5,406	
MP.002	Individual Motor Fuses	386	772	1,158	1,544	1,930	2,316	2,702	1,545	2,318	3,089	3,861	4,634	5,406	
MP.004	Paired Motor Fuses	-	-	-	-	-	-	-	773	1,159	1,545	1,931	2,318	2,703	
MP.003	Individual Circuit Breakers (230V or 460V)	768	1,536	2,304	3,072	3,840	4,608	5,376	3,072	4,608	6,144	7,680	9,216	10,752	
MP.005	Paired Circuit Breakers (230V or 460V)	-	-	-	-	-	-	-	1,537	2,308	3,077	3,844	4,611	5,380	
MTB.001	Individual Motor Terminal Boards	270	540	809	1,077	1,349	1,618	1,878	1,082	1,616	2,157	2,698	3,236	3,755	
MTB.002	Paired Motor Terminal Boards	-	-	-	-	-	-	-	540	809	1,077	1,349	1,618	1,878	
PO.001	Power Outlet (115V)	538	538	538	538	538	538	538	538	538	538	538	538	538	
Mechanical Options															
CM.004	Galvanized Cabinet w/ Side Access	-427	-854	-1,281	-1,708	-2,135	-2,562	-2,989	-1,708	-2,562	-3,416	-4,270	-5,124	-5,978	
LEGS.002	Extended Legs, 30"	193	193	386	290	578	677	773	193	386	290	578	677	773	
LEGS.003	Extended Legs, 36"	193	193	386	290	578	677	773	193	386	290	578	677	773	
LEGS.004	Extended Legs, 42"	193	193	386	290	578	677	773	193	386	290	578	677	773	
LEGS.005	Unit Frame, Std. Legs, 20"	2,730	3,937	5,150	7,377	8,927	10,646	11,888	3,937	5,150	7,377	8,927	10,646	12,365	
LEGS.006	Unit Frame, Ext. Legs, 42"	2,919	4,326	5,730	8,145	9,889	11,805	13,190	4,326	5,730	8,145	9,889	11,805	13,715	
LEGS.007	Paratemp, 20"	-	98	-	486	-	-	-	98	-	486	-	-	-	
LEGS.008	Paratemp, Extended Legs, 30"	-	290	-	775	-	-	-	290	-	775	-	-	-	
LEGS.009	Paratemp, Extended Legs, 36"	-	290	-	775	-	-	-	290	-	775	-	-	-	
LEGS.010	Paratemp, Extended Legs, 42"	-	290	-	775	-	-	-	290	-	775	-	-	-	
HM.00X	Connection Manifold (shipped-loose)	-	-	-	-	-	-	-	1,982	2,577	2,629	2,896	3,006	3,326	



OPTIONS PRICING - FIXED SPEED MODELS

Can't find an option?

Other options and accessories might be available on a custom order basis. Please contact your local Sales Representative or Account Engineer for assistance.

Factory-Installed Fan Cycling, Electrical, and Mechanical Options

- Fans are cycled in pairs on double wide units.
- Pressure fan cycling and variable speed control options are not available on multi-circuited units.
- Variable speed motors are not available for 575/3/60.
- Variable speed motor is on fan closest to header only.
- Variable speed motors have a full speed RPM of 1140 and are typically used on condensers that have either 1140RPM or 830RPM 1.5HP fixed speed motors. For condensers with 830RPM 1HP or 540RPM motors, contact factory for assistance.
- Motor circuit breakers are not available on 575V units.
- Motor terminal boards are not available on units with fan cycling.
- When ordering toggle switch option, please specify whether switches are to be internally or externally mounted.
- Fused disconnect option is only available on units with an MOP of 60 or less. Please see accompanying technical specifications.
- Power outlet is supplied unwired.
- Fan cycling kit does not include control circuit transformer. Optional factory installed control transformers are available to convert 460V or 575V main power supplies to 230V, 115V or 24V control power or 230V main power to 115V or 24V control power.

Option Code	Option Description	List Price Adder by Fan Configuration (US\$)													
		1x1	1x2	1x3	1x4	1x5	1x6	1x7	2x2	2x3	2x4	2x5	2x6	2x7	
Fan Cycling Options (Must Select Fan Cycling and Contactor Option)															
FCC.004	Individual Motor Contactors: 230V, 115V, or 24V	386	772	1,158	1,544	1,930	2,316	2,702	1,545	2,318	3,089	3,861	4,634	5,406	
FCC.001	Paired Motor Contactors: 230V, 115V, or 24V	-	-	-	-	-	-	-	773	1,159	1,545	1,931	2,318	2,703	
FC.003	Ambient Fan Cycling	-	1,480	1,999	2,662	3,326	3,991	4,655	1,480	1,999	2,662	3,326	3,991	4,655	
FC.004	Pressure Fan Cycling Mech. w/o Header	-	2,235	2,448	3,260	4,077	4,893	5,706	2,235	2,448	3,260	4,077	4,893	5,706	
FC.006	Pressure Fan Cycling Mech. w/ Header	2,622	2,830	3,649	4,462	5,281	6,095	6,908	2,830	3,649	4,462	5,281	6,095	6,908	
FC.005	Pressure Fan Cycling Elec. w/o Header	-	2,322	2,909	4,832	6,756	8,675	10,191	2,322	2,909	4,832	6,756	8,675	10,191	
FC.007	Pressure Fan Cycling Elec. w/ Header	2,710	3,294	5,218	7,137	9,065	10,561	12,409	3,294	5,218	7,137	9,065	10,561	12,409	
FC.008	Variable Speed with Ambient	3,754	4,258	4,786	5,452	6,117	6,782	7,448	4,258	4,786	5,452	6,117	6,782	7,448	
FC.010	Variable Speed with Pressure (Mech.)	4,407	4,733	5,237	6,048	6,865	7,683	8,495	4,733	5,237	6,048	6,865	7,683	8,495	
FC.011	Variable Speed with Pressure (Elec.)	4,668	5,171	5,697	7,620	9,544	11,021	12,874	5,171	5,697	7,620	9,544	11,021	12,874	
FC.014	Microprocessor Relay Board	4,612	4,612	4,612	4,612	4,612	4,612	4,612	4,612	4,612	4,612	4,612	4,612	4,612	
FC.015	Microprocessor Relay Board w/ Split	-	-	-	-	-	-	-	4,986	4,986	4,986	4,986	4,986	4,986	
Electrical Options															
CV.002	Control Circuit Transformer: 230V, 115V, or 24V	913	913	913	913	913	913	913	913	913	913	913	913	913	
MP.002	Individual Motor Fuses	386	772	1,158	1,544	1,930	2,316	2,702	1,545	2,318	3,089	3,861	4,634	5,406	
MP.004	Paired Motor Fuses	-	-	-	-	-	-	-	773	1,159	1,545	1,931	2,318	2,703	
MP.003	Individual Circuit Breakers (230V or 460V)	768	1,536	2,304	3,072	3,840	4,608	5,376	3,072	4,608	6,144	7,680	9,216	10,752	
MP.005	Paired Circuit Breakers (230V or 460V)	-	-	-	-	-	-	-	1,537	2,308	3,077	3,844	4,611	5,380	
MTB.001	Individual Motor Terminal Boards	270	540	809	1,077	1,349	1,618	1,878	1,082	1,616	2,157	2,698	3,236	3,755	
MTB.002	Paired Motor Terminal Boards	-	-	-	-	-	-	-	540	809	1,077	1,349	1,618	1,878	
FCS.002	Fan Toggle Switches	162	323	481	642	804	966	1,126	642	966	1,290	1,611	1,924	2,253	
FCS.004	Paired Fan Toggle Switches	-	-	-	-	-	-	-	323	481	642	804	966	1,126	
DISC.002	Fused Disconnect	386	772	1,158	1,544	1,930	2,316	2,702	1,545	2,318	3,089	3,861	4,634	5,406	
COND.001	Sealtite Wiring to Motor Rail	335	416	631	849	1,051	1,263	1,474	849	1,263	1,683	2,110	2,531	2,933	



OPTIONS PRICING - FIXED SPEED MODELS

Can't find an option?

Other options and accessories might be available on a custom order basis. Please contact your local Sales Representative or Account Engineer for assistance.

Factory-Installed Fan Cycling, Electrical, and Mechanical Options

- Fans are cycled in pairs on double wide units.
- Pressure fan cycling and variable speed control options are not available on multi-circuited units.
- Variable speed motors are not available for 575/3/60.
- Variable speed motor is on fan closest to header only.
- Variable speed motors have a full speed RPM of 1140 and are typically used on condensers that have either 1140RPM or 830RPM 1.5HP fixed speed motors. For condensers with 830RPM 1HP or 540RPM motors, contact factory for assistance.
- Motor circuit breakers are not available on 575V units.
- Motor terminal boards are not available on units with fan cycling.
- When ordering toggle switch option, please specify whether switches are to be internally or externally mounted.
- Fused disconnect option is only available on units with an MOP of 60 or less. Please see accompanying technical specifications.
- Power outlet is supplied unwired.
- Fan cycling kit does not include control circuit transformer. Optional factory installed control transformers are available to convert 460V or 575V main power supplies to 230V, 115V or 24V control power or 230V main power to 115V or 24V control power.

Option Code	Option Description	List Price Adder by Fan Configuration (US\$)													
		1x1	1x2	1x3	1x4	1x5	1x6	1x7	2x2	2x3	2x4	2x5	2x6	2x7	
COND.002	Sealtite Wiring to Electrical Box	1,112	2,232	3,349	4,462	5,578	6,699	7,814	4,462	6,696	8,927	10,731	12,875	15,023	
PO.001	Power Outlet (115V)	538	538	538	538	538	538	538	538	538	538	538	538	538	
Mechanical Options															
CM.002	Aluminum Cabinet	427	854	1,281	1,708	2,135	2,562	2,989	1,708	2,562	3,416	4,270	5,124	5,978	
CM.003	Pre-Painted Steel Cabinet	427	854	1,281	1,708	2,135	2,562	2,989	1,708	2,562	3,416	4,270	5,124	5,978	
CM.004	Coil Access Panels, Galv	860	1,720	2,580	3,440	4,300	5,160	6,020	3,440	5,160	6,880	8,600	10,320	12,040	
CM.005	Coil Access Panels, Aluminum	860	1,720	2,580	3,440	4,300	5,160	6,020	3,440	5,160	6,880	8,600	10,320	12,040	
CM.006	Coil Access Panels, Painted Steel	860	1,720	2,580	3,440	4,300	5,160	6,020	3,440	5,160	6,880	8,600	10,320	12,040	
VEN.002	Hinged Venturi	913	1,826	2,739	3,652	4,565	5,478	6,391	3,652	5,478	7,304	9,130	10,956	12,782	
LEGS.002	Extended Legs, 30"	193	193	386	290	578	677	773	193	386	290	578	677	773	
LEGS.003	Extended Legs, 36"	193	193	386	290	578	677	773	193	386	290	578	677	773	
LEGS.004	Extended Legs, 42"	193	193	386	290	578	677	773	193	386	290	578	677	773	
LEGS.005	Unit Frame, Std. Legs, 20"	2,730	3,937	5,150	7,377	8,927	10,646	11,888	3,937	5,150	7,377	8,927	10,646	12,365	
LEGS.006	Unit Frame, Ext. Legs, 42"	2,919	4,326	5,730	8,145	9,889	11,805	13,190	4,326	5,730	8,145	9,889	11,805	13,715	
LEGS.007	Paratemp, 20"	-	98	-	486	-	-	-	98	-	486	-	-	-	
LEGS.008	Paratemp, Extended Legs, 30"	-	290	-	775	-	-	-	290	-	775	-	-	-	
LEGS.009	Paratemp, Extended Legs, 36"	-	290	-	775	-	-	-	290	-	775	-	-	-	
LEGS.010	Paratemp, Extended Legs, 42"	-	290	-	775	-	-	-	290	-	775	-	-	-	
HM.00X	Connection Manifold (shipped-loose)	-	-	-	-	-	-	-	1,982	2,577	2,629	2,896	3,006	3,326	



AIR-COOLED CONDENSERS

1 - 26 Ton

COIL OPTIONS PRICING - ALL MODELS

Can't find an option?

Other options and accessories might be available on a custom order basis. Please contact your local Sales Representative or Account Engineer for assistance.

Condenser Fin and Coil Protection Options

Standard Fins Per Inch is 10. 8 FPI reduces the capacity of a model and 12 FPI and 14 FPI increase the capacity of a model.

Larkin Config Model	List Price Adder (\$US)							
	Fins Per Inch (FPI) Options				Coil Protection Options			
	8 FPI	10 FPI	12 FPI	14 FPI	ProKote™ Fin Protection	ElectroFin Coils	Bronz-Glow Coating	Copper Fin Coil
Models with Venturi-Mount VSEC Motors								
LNES01A008	-643	Standard	643	1,294	1,498	Call	Call	Call
LNES01A009	-643	Standard	643	1,294	1,981	Call	Call	Call
LNES02A011	-1285	Standard	1,285	2,586	2,016	Call	Call	Call
LNES02A015	-1294	Standard	1,294	2,580	2,415	Call	Call	Call
LNES02A018	-1294	Standard	1,294	2,580	3,923	Call	Call	Call
LNES03A023	-1,935	Standard	1,935	3,870	4,456	Call	Call	Call
LNES03A027	-1,935	Standard	1,935	3,870	6,360	Call	Call	Call
LNES04A031	-2,580	Standard	2,580	5,157	6,720	Call	Call	Call
LNES04A036	-2,580	Standard	2,580	5,157	8,962	Call	Call	Call
LNES05A039	-3,224	Standard	3,224	6,448	8,387	Call	Call	Call
LNES05A047	-3,224	Standard	3,224	6,448	11,182	Call	Call	Call
LNES06A056	-3,870	Standard	3,870	7,738	13,425	Call	Call	Call
LNES07A065	-4,512	Standard	4,512	9,029	15,667	Call	Call	Call
LNED04A023	-2,572	Standard	2,572	5,173	4,024	Call	Call	Call
LNED04A031	-2,580	Standard	2,580	5,157	5,941	Call	Call	Call
LNED04A036	-2,580	Standard	2,580	5,157	7,851	Call	Call	Call
LNED06A046	-3,870	Standard	3,870	7,738	8,910	Call	Call	Call
LNED06A054	-3,870	Standard	3,870	7,738	12,718	Call	Call	Call
LNED08A062	-5,157	Standard	5,157	10,318	13,443	Call	Call	Call
LNED08A073	-5,157	Standard	5,157	10,318	17,922	Call	Call	Call
LNED10A079	-6,448	Standard	6,448	12,898	16,777	Call	Call	Call
LNED10A093	-6,448	Standard	6,448	12,898	22,371	Call	Call	Call
LNED12A112	-7,738	Standard	7,738	15,476	26,851	Call	Call	Call
LNED14A129	-9,029	Standard	9,029	18,055	31,330	Call	Call	Call
Models with 540 RPM (0.5HP) Motors								
LNQS01A005	-643	Standard	643	1,294	1,498	Call	Call	Call
LNQS01A006	-643	Standard	643	1,294	1,981	Call	Call	Call
LNQS02A008	-1285	Standard	1,285	2,586	2,016	Call	Call	Call
LNQS02A010	-1294	Standard	1,294	2,580	2,415	Call	Call	Call
LNQS02A011	-1294	Standard	1,294	2,580	3,923	Call	Call	Call
LNQS03A016	-1,935	Standard	1,935	3,870	4,456	Call	Call	Call



AIR-COOLED CONDENSERS

1 - 26 Ton

COIL OPTIONS PRICING - ALL MODELS

Can't find an option?

Other options and accessories might be available on a custom order basis. Please contact your local Sales Representative or Account Engineer for assistance.

Condenser Fin and Coil Protection Options

Standard Fins Per Inch is 10. 8 FPI reduces the capacity of a model and 12 FPI and 14 FPI increase the capacity of a model.

Larkin Config Model	List Price Adder (\$US)							
	Fins Per Inch (FPI) Options				Coil Protection Options			
	8 FPI	10 FPI	12 FPI	14 FPI	ProKote™ Fin Protection	ElectroFin Coils	Bronz-Glow Coating	Copper Fin Coil
LNQS03A017	-1,935	Standard	1,935	3,870	6,360	Call	Call	Call
LNQS04A021	-2,580	Standard	2,580	5,157	6,720	Call	Call	Call
LNQS04A023	-2,580	Standard	2,580	5,157	8,962	Call	Call	Call
LNQS05A026	-3,224	Standard	3,224	6,448	8,387	Call	Call	Call
LNQS05A029	-3,224	Standard	3,224	6,448	11,182	Call	Call	Call
LNQS06A034	-3,870	Standard	3,870	7,738	13,425	Call	Call	Call
LNQS07A042	-4,512	Standard	4,512	9,029	15,667	Call	Call	Call
LNQD04A016	-2,572	Standard	2,572	5,173	4,024	Call	Call	Call
LNQD04A021	-2,580	Standard	2,580	5,157	5,941	Call	Call	Call
LNQD04A023	-2,580	Standard	2,580	5,157	7,851	Call	Call	Call
LNQD06A031	-3,870	Standard	3,870	7,738	8,910	Call	Call	Call
LNQD06A034	-3,870	Standard	3,870	7,738	12,718	Call	Call	Call
LNQD08A041	-5,157	Standard	5,157	10,318	13,443	Call	Call	Call
LNQD08A046	-5,157	Standard	5,157	10,318	17,922	Call	Call	Call
LNQD10A052	-6,448	Standard	6,448	12,898	16,777	Call	Call	Call
LNQD10A057	-6,448	Standard	6,448	12,898	22,371	Call	Call	Call
LNQD12A069	-7,738	Standard	7,738	15,476	26,851	Call	Call	Call
LNQD14A083	-9,029	Standard	9,029	18,055	31,330	Call	Call	Call
Models with 830 RPM (1.0HP) Motors								
LNXS01A006	-643	Standard	643	1,294	1,498	Call	Call	Call
LNXS01A008	-643	Standard	643	1,294	1,981	Call	Call	Call
LNXS02A010	-1,285	Standard	1,285	2,586	2,016	Call	Call	Call
LNXS02A013	-1,294	Standard	1,294	2,580	2,415	Call	Call	Call
LNXS02A015	-1,294	Standard	1,294	2,580	3,923	Call	Call	Call
LNXS03A020	-1,935	Standard	1,935	3,870	4,456	Call	Call	Call
LNXS03A023	-1,935	Standard	1,935	3,870	6,360	Call	Call	Call
LNXS04A026	-2,580	Standard	2,580	5,157	6,720	Call	Call	Call
LNXS04A030	-2,580	Standard	2,580	5,157	8,962	Call	Call	Call
LNXS05A033	-3,224	Standard	3,224	6,448	8,387	Call	Call	Call
LNXS05A038	-3,224	Standard	3,224	6,448	11,182	Call	Call	Call
LNXS06A045	-3,870	Standard	3,870	7,738	13,425	Call	Call	Call



AIR-COOLED CONDENSERS

1 - 26 Ton

COIL OPTIONS PRICING - ALL MODELS

Can't find an option?

Other options and accessories might be available on a custom order basis. Please contact your local Sales Representative or Account Engineer for assistance.

Condenser Fin and Coil Protection Options

Standard Fins Per Inch is 10. 8 FPI reduces the capacity of a model and 12 FPI and 14 FPI increase the capacity of a model.

Larkin Config Model	List Price Adder (\$US)							
	Fins Per Inch (FPI) Options				Coil Protection Options			
	8 FPI	10 FPI	12 FPI	14 FPI	ProKote™ Fin Protection	ElectroFin Coils	Bronz-Glow Coating	Copper Fin Coil
LNXS07A052	-4,512	Standard	4,512	9,029	15,667	Call	Call	Call
LNXD04A020	-2,572	Standard	2,572	5,173	4,024	Call	Call	Call
LNXD04A026	-2,580	Standard	2,580	5,157	5,941	Call	Call	Call
LNXD04A030	-2,580	Standard	2,580	5,157	7,851	Call	Call	Call
LNXD06A039	-3,870	Standard	3,870	7,738	8,910	Call	Call	Call
LNXD06A045	-3,870	Standard	3,870	7,738	12,718	Call	Call	Call
LNXD08A052	-5,157	Standard	5,157	10,318	13,443	Call	Call	Call
LNXD08A061	-5,157	Standard	5,157	10,318	17,922	Call	Call	Call
LNXD10A066	-6,448	Standard	6,448	12,898	16,777	Call	Call	Call
LNXD10A076	-6,448	Standard	6,448	12,898	22,371	Call	Call	Call
LNXD12A091	-7,738	Standard	7,738	15,476	26,851	Call	Call	Call
LNXD14A104	-9,029	Standard	9,029	18,055	31,330	Call	Call	Call
Models with 830 RPM (1.5HP) Motors								
LNLS01A007	-643	Standard	643	1,294	1,498	Call	Call	Call
LNLS01A008	-643	Standard	643	1,294	1,981	Call	Call	Call
LNLS02A010	-1285	Standard	1,285	2,586	2,016	Call	Call	Call
LNLS02A014	-1294	Standard	1,294	2,580	2,415	Call	Call	Call
LNLS02A016	-1294	Standard	1,294	2,580	3,923	Call	Call	Call
LNLS03A021	-1935	Standard	1,935	3,870	4,456	Call	Call	Call
LNLS03A024	-1935	Standard	1,935	3,870	6,360	Call	Call	Call
LNLS04A028	-2580	Standard	2,580	5,157	6,720	Call	Call	Call
LNLS04A032	-2580	Standard	2,580	5,157	8,962	Call	Call	Call
LNLS05A035	-3224	Standard	3,224	6,448	8,387	Call	Call	Call
LNLS05A042	-3224	Standard	3,224	6,448	11,182	Call	Call	Call
LNLS06A050	-3870	Standard	3,870	7,738	13,425	Call	Call	Call
LNLS07A055	-4512	Standard	4,512	9,029	15,667	Call	Call	Call
LNLD04A020	-2572	Standard	2,572	5,173	4,024	Call	Call	Call
LNLD04A028	-2580	Standard	2,580	5,157	5,941	Call	Call	Call
LNLD04A032	-2580	Standard	2,580	5,157	7,851	Call	Call	Call
LNLD06A042	-3870	Standard	3,870	7,738	8,910	Call	Call	Call
LNLD06A048	-3870	Standard	3,870	7,738	12,718	Call	Call	Call



AIR-COOLED CONDENSERS

1 - 26 Ton

COIL OPTIONS PRICING - ALL MODELS

Can't find an option?

Other options and accessories might be available on a custom order basis. Please contact your local Sales Representative or Account Engineer for assistance.

Condenser Fin and Coil Protection Options

Standard Fins Per Inch is 10. 8 FPI reduces the capacity of a model and 12 FPI and 14 FPI increase the capacity of a model.

Larkin Config Model	List Price Adder (\$US)							
	Fins Per Inch (FPI) Options				Coil Protection Options			
	8 FPI	10 FPI	12 FPI	14 FPI	ProKote™ Fin Protection	ElectroFin Coils	Bronz-Glow Coating	Copper Fin Coil
LNLD08A056	-5157	Standard	5,157	10,318	13,443	Call	Call	Call
LNLD08A065	-5157	Standard	5,157	10,318	17,922	Call	Call	Call
LNLD10A071	-6448	Standard	6,448	12,898	16,777	Call	Call	Call
LNLD10A083	-6448	Standard	6,448	12,898	22,371	Call	Call	Call
LNLD12A100	-7738	Standard	7,738	15,476	26,851	Call	Call	Call
LNLD14A110	-9029	Standard	9,029	18,055	31,330	Call	Call	Call
Models with 1140 RPM (1.5HP) Motors								
LNHS01A007	-643	Standard	643	1,294	1,498	Call	Call	Call
LNHS01A009	-643	Standard	643	1,294	1,981	Call	Call	Call
LNHS02A011	-1,285	Standard	1,285	2,586	2,016	Call	Call	Call
LNHS02A015	-1,294	Standard	1,294	2,580	2,415	Call	Call	Call
LNHS02A017	-1,294	Standard	1,294	2,580	3,923	Call	Call	Call
LNHS03A022	-1,935	Standard	1,935	3,870	4,456	Call	Call	Call
LNHS03A026	-1,935	Standard	1,935	3,870	6,360	Call	Call	Call
LNHS04A029	-2,580	Standard	2,580	5,157	6,720	Call	Call	Call
LNHS04A034	-2,580	Standard	2,580	5,157	8,962	Call	Call	Call
LNHS05A037	-3,224	Standard	3,224	6,448	8,387	Call	Call	Call
LNHS05A044	-3,224	Standard	3,224	6,448	11,182	Call	Call	Call
LNHS06A053	-3,870	Standard	3,870	7,738	13,425	Call	Call	Call
LNHS07A061	-4,512	Standard	4,512	9,029	15,667	Call	Call	Call
LNHD04A021	-2,572	Standard	2,572	5,173	4,024	Call	Call	Call
LNHD04A029	-2,580	Standard	2,580	5,157	5,941	Call	Call	Call
LNHD04A034	-2,580	Standard	2,580	5,157	7,851	Call	Call	Call
LNHD06A044	-3,870	Standard	3,870	7,738	8,910	Call	Call	Call
LNHD06A051	-3,870	Standard	3,870	7,738	12,718	Call	Call	Call
LNHD08A058	-5,157	Standard	5,157	10,318	13,443	Call	Call	Call
LNHD08A068	-5,157	Standard	5,157	10,318	17,922	Call	Call	Call
LNHD10A074	-6,448	Standard	6,448	12,898	16,777	Call	Call	Call
LNHD10A088	-6,448	Standard	6,448	12,898	22,371	Call	Call	Call
LNHD12A106	-7,738	Standard	7,738	15,476	26,851	Call	Call	Call
LNHD14A122	-9,029	Standard	9,029	18,055	31,330	Call	Call	Call



AIR-COOLED CONDENSERS

1 - 26 Ton

COIL OPTIONS PRICING - ALL MODELS

Can't find an option?

Other options and accessories might be available on a custom order basis. Please contact your local Sales Representative or Account Engineer for assistance.

Condenser Fin and Coil Protection Options

Standard Fins Per Inch is 10. 8 FPI reduces the capacity of a model and 12 FPI and 14 FPI increase the capacity of a model.

Larkin Config Model	List Price Adder (\$US)							
	Fins Per Inch (FPI) Options				Coil Protection Options			
	8 FPI	10 FPI	12 FPI	14 FPI	ProKote™ Fin Protection	ElectroFin Coils	Bronz-Glow Coating	Copper Fin Coil
Models with Rail-Mount VSEC (1140 RPM) Motors								
LNKS01A007	-643	Standard	643	1,294	1,498	Call	Call	Call
LNKS01A009	-643	Standard	643	1,294	1,981	Call	Call	Call
LNKS02A011	-1,285	Standard	1,285	2,586	2,016	Call	Call	Call
LNKS02A015	-1,294	Standard	1,294	2,580	2,415	Call	Call	Call
LNKS02A017	-1,294	Standard	1,294	2,580	3,923	Call	Call	Call
LNKS03A022	-1,935	Standard	1,935	3,870	4,456	Call	Call	Call
LNKS03A026	-1,935	Standard	1,935	3,870	6,360	Call	Call	Call
LNKS04A029	-2,580	Standard	2,580	5,157	6,720	Call	Call	Call
LNKS04A034	-2,580	Standard	2,580	5,157	8,962	Call	Call	Call
LNKS05A037	-3,224	Standard	3,224	6,448	8,387	Call	Call	Call
LNKS05A044	-3,224	Standard	3,224	6,448	11,182	Call	Call	Call
LNKS06A053	-3,870	Standard	3,870	7,738	13,425	Call	Call	Call
LNKS07A061	-4,512	Standard	4,512	9,029	15,667	Call	Call	Call
LNKD04A021	-2,572	Standard	2,572	5,173	4,024	Call	Call	Call
LNKD04A029	-2,580	Standard	2,580	5,157	5,941	Call	Call	Call
LNKD04A034	-2,580	Standard	2,580	5,157	7,851	Call	Call	Call
LNKD06A044	-3,870	Standard	3,870	7,738	8,910	Call	Call	Call
LNKD06A051	-3,870	Standard	3,870	7,738	12,718	Call	Call	Call
LNKD08A058	-5,157	Standard	5,157	10,318	13,443	Call	Call	Call
LNKD08A068	-5,157	Standard	5,157	10,318	17,922	Call	Call	Call
LNKD10A074	-6,448	Standard	6,448	12,898	16,777	Call	Call	Call
LNKD10A088	-6,448	Standard	6,448	12,898	22,371	Call	Call	Call
LNKD12A106	-7,738	Standard	7,738	15,476	26,851	Call	Call	Call
LNKD14A122	-9,029	Standard	9,029	18,055	31,330	Call	Call	Call
Models with Rail-Mount VSEC (830 RPM) Motors								
LNJS01A007	-643	Standard	643	1,294	1,498	Call	Call	Call
LNJS01A008	-643	Standard	643	1,294	1,981	Call	Call	Call
LNJS02A010	-1,285	Standard	1,285	2,586	2,016	Call	Call	Call
LNJS02A014	-1,294	Standard	1,294	2,580	2,415	Call	Call	Call
LNJS02A016	-1,294	Standard	1,294	2,580	3,923	Call	Call	Call



AIR-COOLED CONDENSERS

1 - 26 Ton

COIL OPTIONS PRICING - ALL MODELS

Can't find an option?

Other options and accessories might be available on a custom order basis. Please contact your local Sales Representative or Account Engineer for assistance.

Condenser Fin and Coil Protection Options

Standard Fins Per Inch is 10. 8 FPI reduces the capacity of a model and 12 FPI and 14 FPI increase the capacity of a model.

Larkin Config Model	List Price Adder (\$US)							
	Fins Per Inch (FPI) Options				Coil Protection Options			
	8 FPI	10 FPI	12 FPI	14 FPI	ProKote™ Fin Protection	ElectroFin Coils	Bronz-Glow Coating	Copper Fin Coil
LNJS03A021	-1,935	Standard	1,935	3,870	4,456	Call	Call	Call
LNJS03A024	-1,935	Standard	1,935	3,870	6,360	Call	Call	Call
LNJS04A028	-2,580	Standard	2,580	5,157	6,720	Call	Call	Call
LNJS04A032	-2,580	Standard	2,580	5,157	8,962	Call	Call	Call
LNJS05A035	-3,224	Standard	3,224	6,448	8,387	Call	Call	Call
LNJS05A042	-3,224	Standard	3,224	6,448	11,182	Call	Call	Call
LNJS06A050	-3,870	Standard	3,870	7,738	13,425	Call	Call	Call
LNJS07A055	-4,512	Standard	4,512	9,029	15,667	Call	Call	Call
LNJD04A020	-2,572	Standard	2,572	5,173	4,024	Call	Call	Call
LNJD04A028	-2,580	Standard	2,580	5,157	5,941	Call	Call	Call
LNJD04A032	-2,580	Standard	2,580	5,157	7,851	Call	Call	Call
LNJD06A042	-3,870	Standard	3,870	7,738	8,910	Call	Call	Call
LNJD06A048	-3,870	Standard	3,870	7,738	12,718	Call	Call	Call
LNJD08A056	-5,157	Standard	5,157	10,318	13,443	Call	Call	Call
LNJD08A065	-5,157	Standard	5,157	10,318	17,922	Call	Call	Call
LNJD10A071	-6,448	Standard	6,448	12,898	16,777	Call	Call	Call
LNJD10A083	-6,448	Standard	6,448	12,898	22,371	Call	Call	Call
LNJD12A100	-7,738	Standard	7,738	15,476	26,851	Call	Call	Call
LNJD14A110	-9,029	Standard	9,029	18,055	31,330	Call	Call	Call



CONDENSER

NTC Gas Cooler

To meet the growing demand of CO₂ systems and to offer our customers a suite of product solutions to meet Low GWP regulations, Heatcraft Refrigeration Products is proud to offer the NTC Gas Cooler product line specifically designed to be used in transcritical CO₂ applications. The NTC gas cooler line offers our customers ample capacity range from 10 to 275 tons to satisfy an array of applications and uses the latest variable speed motor technology to provide critical sound and energy performance where significant energy savings are essential.



NOMENCLATURE



L	G	E	047	S	04	C	10	A
Brand	Product Family	Motor	Nominal Capacity	Width	# of Fans	Voltage	FPI	Revision
B = Bohn L = Larkin C = Climate Control H = Chandler	G = Gas Cooler	E = Venturi Mounted VSEC, 2.0 kW	012 = 12 Tons 026 = 26 Tons 040 = 40 Tons 047 = 47 Tons Etc.	S = Single D = Double	04 = 4 06 = 6	C = 208-230/3/60 D = 460/3/60 E = 575/3/60	08 10 12 14	

OVERVIEW

STANDARD FEATURES

- EBM EC Variable Speed motor, swept fan blade with integrated Venturi
- Broad capacity range from 10 to 275 tons
- 10 FPI coil
- Galvanized steel cabinet is standard with painted galvanized steel or aluminum housing available as an option
- Side access panels for ease of cleaning coils
- Non-fused, through-the-door disconnect
- All models with 10 or more fans will have an oversized e-box
- UL and UL listed for Canada
- Coil design pressure is 1886psig and UL listed

AVAILABLE OPTIONS

- Multi-circuiting at no additional charge
- Optional 8, 12 or 14 FPI spacing
- Fan-cycle control panels
- Alternate Prokote protected coil available
- Extended condenser legs for increased ground clearance
- Motor fusing
- Motor terminal boards
- Power outlet (115V)



CONFIGURABLE 4 ROW MODELS

Base Model		List Price (\$US)	Fan Configuration	Factory Installed: A la Carte Options (List Price Adder US\$)
208-230/3/60	460/3/60			Prokote Fin Protection
LGE010S01C08A	LGE010S01D08A	48,155	1x1	1,077
LGE012S01C10A	LGE012S01D10A	48,670	1x1	1,348
LGE013S01C12A	LGE013S01D12A	49,185	1x1	1,618
LGE014S01C14A	LGE014S01D14A	49,700	1x1	1,887
LGE025S02C08A	LGE025S02D08A	78,217	1x2	2,156
LGE026S02C10A	LGE026S02D10A	79,247	1x2	2,693
LGE029S02C12A	LGE029S02D12A	80,278	1x2	3,233
LGE032S02C14A	LGE032S02D14A	81,586	1x2	3,496
LGE033S03C08A	LGE033S03D08A	108,285	1x3	3,233
LGE040S03C10A	LGE040S03D10A	110,249	1x3	3,626
LGE043S03C12A	LGE043S03D12A	111,382	1x3	4,847
LGE046S03C14A	LGE046S03D14A	112,927	1x3	5,656
LGE046S04C08A	LGE046S04D08A	136,823	1x4	4,310
LGE047S04C10A	LGE047S04D10A	139,442	1x4	4,833
LGE052S04C12A	LGE052S04D12A	140,949	1x4	6,464
LGE056S04C14A	LGE056S04D14A	143,011	1x4	7,541
LGE054S05C08A	LGE054S05D08A	166,480	1x5	5,387
LGE064S05C10A	LGE064S05D10A	169,059	1x5	6,733
LGE068S05C12A	LGE068S05D12A	171,637	1x5	8,079
LGE074S05C14A	LGE074S05D14A	174,214	1x5	9,428
LGE067S06C08A	LGE067S06D08A	195,805	1x6	6,464
LGE079S06C10A	LGE079S06D10A	198,897	1x6	8,079
LGE086S06C12A	LGE086S06D12A	201,993	1x6	9,696
LGE093S06C14A	LGE093S06D14A	205,085	1x6	11,310
LGE080S07C08A	LGE080S07D08A	224,594	1x7	7,541
LGE094S07C10A	LGE094S07D10A	228,202	1x7	9,428
LGE102S07C12A	LGE102S07D12A	231,813	1x7	11,310
LGE112S07C14A	LGE112S07D14A	235,421	1x7	13,196
LGE049D04C08A	LGE049D04D08A	148,546	2x2	4,314
LGE053D04C10A	LGE053D04D10A	150,611	2x2	5,386
LGE058D04C12A	LGE058D04D12A	152,671	2x2	6,465
LGE063D04C14A	LGE063D04D14A	155,289	2x2	6,989
LGE067D06C08A	LGE067D06D08A	207,324	2x3	6,465
LGE079D06C10A	LGE079D06D10A	211,251	2x3	7,250
LGE086D06C12A	LGE086D06D12A	213,515	2x3	9,697
LGE093D06C14A	LGE093D06D14A	216,606	2x3	11,315
LGE093D08C08A	LGE093D08D08A	264,088	2x4	8,620
LGE094D08C10A	LGE094D08D10A	269,322	2x4	9,666



CONFIGURABLE 4 ROW MODELS

Base Model		List Price (\$US)	Fan Configuration	Factory Installed: A la Carte Options (List Price Adder US\$)
208-230/3/60	460/3/60			Prokote Fin Protection
LGE103D08C12A	LGE103D08D12A	272,339	2x4	12,929
LGE112D08C14A	LGE112D08D14A	276,464	2x4	15,083
LGE108D10C08A	LGE108D10D08A	323,533	2x5	10,775
LGE128D10C10A	LGE128D10D10A	328,691	2x5	13,467
LGE136D10C12A	LGE136D10D12A	333,849	2x5	16,161
LGE148D10C14A	LGE148D10D14A	339,002	2x5	18,852
LGE134D12C08A	LGE134D12D08A	381,069	2x6	12,929
LGE158D12C10A	LGE158D12D10A	387,255	2x6	16,161
LGE171D12C12A	LGE171D12D12A	393,444	2x6	19,391
LGE186D12C14A	LGE186D12D14A	399,633	2x6	22,624
LGE159D14C08A	LGE159D14D08A	443,469	2x7	15,083
LGE189D14C10A	LGE189D14D10A	450,689	2x7	18,852
LGE205D14C12A	LGE205D14D12A	457,907	2x7	22,624
LGE223D14C14A	LGE223D14D14A	465,124	2x7	26,392



CONFIGURABLE 6 ROW MODELS

Base Model		List Price (\$US)	Fan Configuration	Factory Installed: A la Carte Options (List Price Adder US\$)
208-230/3/60	460/3/60			Prokote Fin Protection
LGE015S01C08A	LGE015S01D08A	62,724	1x1	1,781
LGE017S01C10A	LGE017S01D10A	63,563	1x1	2,225
LGE019S01C12A	LGE019S01D12A	64,408	1x1	2,671
LGE020S01C14A	LGE020S01D14A	65,248	1x1	3,114
LGE031S02C08A	LGE031S02D08A	97,606	1x2	3,559
LGE035S02C10A	LGE035S02D10A	99,287	1x2	4,449
LGE038S02C12A	LGE038S02D12A	100,972	1x2	5,336
LGE040S02C14A	LGE040S02D14A	102,656	1x2	6,227
LGE045S03C08A	LGE045S03D08A	133,045	1x3	5,336
LGE052S03C10A	LGE052S03D10A	135,574	1x3	6,671
LGE056S03C12A	LGE056S03D12A	138,099	1x3	8,005
LGE059S03C14A	LGE059S03D14A	140,626	1x3	9,339
LGE063S04C08A	LGE063S04D08A	166,244	1x4	7,117
LGE069S04C10A	LGE069S04D10A	169,612	1x4	8,893
LGE075S04C12A	LGE075S04D12A	172,982	1x4	10,675
LGE080S04C14A	LGE080S04D14A	176,351	1x4	12,452
LGE078S05C08A	LGE078S05D08A	199,484	1x5	8,893
LGE089S05C10A	LGE089S05D10A	203,695	1x5	11,118
LGE097S05C12A	LGE097S05D12A	207,908	1x5	13,341
LGE102S05C14A	LGE102S05D14A	212,118	1x5	15,564
LGE089S06C08A	LGE089S06D08A	233,263	1x6	10,675
LGE101S06C10A	LGE101S06D10A	238,316	1x6	13,341
LGE110S06C12A	LGE110S06D12A	243,370	1x6	16,010
LGE116S06C14A	LGE116S06D14A	248,425	1x6	18,679
LGE106S07C08A	LGE106S07D08A	266,628	1x7	14,361
LGE121S07C10A	LGE121S07D10A	272,516	1x7	15,576
LGE131S07C12A	LGE131S07D12A	277,788	1x7	19,320
LGE138S07C14A	LGE138S07D14A	284,328	1x7	21,791
LGE062D04C08A	LGE062D04D08A	187,324	2x2	7,118
LGE069D04C10A	LGE069D04D10A	190,686	2x2	8,895
LGE076D04C12A	LGE076D04D12A	194,058	2x2	10,676
LGE080D04C14A	LGE080D04D14A	197,425	2x2	12,455
LGE090D06C08A	LGE090D06D08A	256,843	2x3	10,676
LGE103D06C10A	LGE103D06D10A	261,898	2x3	13,345
LGE112D06C12A	LGE112D06D12A	266,949	2x3	16,011
LGE119D06C14A	LGE119D06D14A	272,004	2x3	18,679
LGE125D08C08A	LGE125D08D08A	322,928	2x4	14,233
LGE138D08C10A	LGE138D08D10A	329,666	2x4	17,788



CONFIGURABLE 6 ROW MODELS

Base Model		List Price (\$US)	Fan Configuration	Factory Installed: A la Carte Options (List Price Adder US\$)
208-230/3/60	460/3/60			Prokote Fin Protection
LGE151D08C12A	LGE151D08D12A	336,403	2x4	21,347
LGE160D08C14A	LGE160D08D14A	343,140	2x4	24,903
LGE156D10C08A	LGE156D10D08A	389,544	2x5	17,788
LGE178D10C10A	LGE178D10D10A	397,967	2x5	22,238
LGE194D10C12A	LGE194D10D12A	406,392	2x5	26,685
LGE204D10C14A	LGE204D10D14A	414,815	2x5	31,130
LGE177D12C08A	LGE177D12D08A	455,984	2x6	21,347
LGE202D12C10A	LGE202D12D10A	466,090	2x6	26,685
LGE220D12C12A	LGE220D12D12A	476,199	2x6	32,019
LGE232D12C14A	LGE232D12D14A	486,307	2x6	37,354
LGE212D14C08A	LGE212D14D08A	528,744	2x7	28,722
LGE241D14C10A	LGE241D14D10A	540,520	2x7	31,153
LGE262D14C12A	LGE262D14D12A	551,062	2x7	38,638
LGE275D14C14A	LGE275D14D14A	564,145	2x7	43,580



OPTIONS PRICING

Can't Find an Option?

Other options and accessories might be available on a custom order basis. Please contact your local Sales Representative or Account Engineer for assistance.

Factory-Installed Fan Cycling, Electrical, and Mechanical Options

- Motors are 208-230/3/60 or 460/3/60.
- Fused disconnect option is only available on units with an MOP of 60 or less. Please see accompanying technical specifications.

Option Code	Option Description	Factory Installed: A la Carte Options (List Price Adder US\$)													
		1x1	1x2	1x3	1x4	1x5	1x6	1x7	2x2	2x3	2x4	2x5	2x6	2x7	
FC.019	Proportional Pressure Control	3,426	3,426	3,426	3,426	3,426	3,426	3,426	3,426	6,846	6,846	6,846	6,846	6,846	7,245
ELECTRICAL OPTIONS															
DISC.002	Fused Disconnect	375	750	1,125	1,500	1,875	2,250	2,625	1,500	2,250	3,000	3,750	4,500	5,250	
MP.002	Individual Motor Fuses	375	750	1,125	1,500	1,875	2,250	2,625	1,500	2,250	3,000	3,750	4,500	5,250	
MP.004	Paired Motor Fuses	-	-	-	-	-	-	-	750	1,125	1,500	1,875	2,250	2,625	
MP.003	Individual circuit breakers (230V or 460V)	746	1,492	2,238	2,984	3,730	4,476	5,222	2,984	4,476	5,968	7,460	8,952	10,444	
MP.005	Paired circuit breakers (230V or 460V)	-	-	-	-	-	-	-	1,492	2,238	2,984	3,730	4,476	5,222	
MTB.001	Individual motor terminal boards	262	524	785	1,046	1,310	1,571	1,823	1,040	1,564	2,096	2,618	3,543	4,059	
MTB.002	Paired motor terminal boards	-	-	-	-	-	-	-	522	781	1,046	1,310	1,571	1,823	
PO.001	Power outlet (115V)	522	522	522	522	522	522	522	522	522	522	522	522	522	
MECHANICAL OPTIONS															
CM.002	Aluminum cabinet	415	830	1,245	1,660	2,075	2,490	2,905	1,660	2,490	3,320	4,150	4,980	5,810	
CM.003	Pre-painted steel cabinet	415	830	1,245	1,660	2,075	2,490	2,905	1,660	2,490	3,320	4,150	4,980	5,810	
LEGS.002	Extended legs, 30"	187	187	375	282	561	657	750	187	375	282	561	657	750	
LEGS.003	Extended legs, 36"	187	187	375	282	561	657	750	187	375	282	561	657	750	
LEGS.004	Extended legs, 42"	187	187	375	282	561	657	750	187	375	282	561	657	750	
LEGS.005	Unit frame, std. legs, 20"	2,650	3,822	5,000	7,162	8,667	10,336	11,542	3,822	5,000	7,162	8,667	10,336	12,005	
LEGS.006	Unit frame, Ext. legs, 42"	2,834	4,200	5,563	7,908	9,601	11,461	12,806	4,200	5,563	7,908	9,601	11,461	13,316	
LEGS.007	Paratemp, 20"	-	95	-	472	-	-	-	95	-	472	-	-	-	
LEGS.008	Paratemp, extended legs, 30"	-	282	-	752	-	-	-	282	-	752	-	-	-	
LEGS.009	Paratemp, extended legs, 36"	-	282	-	752	-	-	-	282	-	752	-	-	-	
LEGS.010	Paratemp, extended legs, 42"	-	282	-	752	-	-	-	282	-	752	-	-	-	
HM.00X	Connection manifold (shipped loose)	-	-	-	-	-	-	-	1,924	2,502	2,552	2,812	2,918	3,417	



FLUID COOLERS

FN Fluid Coolers

Direct drive fluid coolers with vertical air flow are designed to save time on installation, provide excellent performance, long service life and a wide range of performance selections. These units are ideal for commercial/industrial locations.



NOMENCLATURE



F	N	H	S	01	H	3	01
Product Line	Vintage	Model	Width	Fans	Tube Diameter	Rows	Coil Model #
F = Fluid Coolers		H = 1140 RPM, 1.5 HP L = 830 RPM, 1.5 HP Q = 540 RPM, 0.5 HP E = VSEC Motor	S = Single D = Double	# of Fans (01 - 12)	H = 1/2" F = 5/8"	# of Rows (2 - 4)	

OVERVIEW

STANDARD FEATURES

- 10 fins per inch spacing standard. 8, 12, and 14 fins per inch spacing available as an option.
- 1/2" models feature a Floating Tube coil design and 5/8" models feature a bushing plate floating tube coil design. These coil designs virtually eliminate tube sheet leaks. Coil includes a 5 year leak warranty at tube sheets and center supports.
- Internal baffles provided between all fan cells
- Fluid Coolers from 1 to 5 fans in length are available with 1/2" diameter tubes to maximize heat transfer. Fluid Coolers from 3 to 6 fans in length are available with 5/8" diameter tubes to minimize fluid pressure drop.
- Wide selection of circuit options maximize performance at minimal cost
- Coated steel fan guards for optimal corrosion protection
- Weather resistant control panel with factory-mounted door interrupt disconnect switch
- Coils are fabricated with corrugated aluminum fins with staggered copper tubes for optimum heat transfer. All units are pressure tested prior to shipment
- 2 year product warranty

Models with Variable Speed EC Motors (VSEC) - FNE Models

- EC motor, swept fan blade and venture incorporating integrated variable speed technology

- Aluminum housing for an attractive appearance and corrosion protection, with painted galvanized steel, or galvanized steel as an option
- Side access panels for ease of cleaning coils
- 3-year warranty on EC Motorst

Models with 830 or 540 RPM Fixed Speed Motors - FNL or FNQ Models

- Direct drive fan motors in 830 or 540 RPM
- Fan blade provides an unprecedented sound level of 49.6 dBA (540 RPM @ 10 ft.)
- ServiceEase motor mount feature, allows for ease of motor service and reduces likelihood of damage to the coils during servicing
- Coils incorporate the latest advancements in coil technology to provide maximum capacity
- Galvanized steel housing
- High efficiency, three-phase fan motors with ball bearings and internal overload protection

Models with 1140 RPM Fixed Speed Motors - FNH Models

- Direct drive fan motors
- Patented ServiceEase motor mount
- New, high efficiency coil designed for optimum performance
- Galvanized steel housing
- High efficiency, three-phase fan motors with ball bearings and internal overload protection



FNH MODELS 1.5 HP 1140 RPM MOTORS

Need to Customize?

- Look on page FC-6 for factory-installed fan cycling, electrical, and mechanical options.
- Look on page FC-9 for condenser fin and coil protection options.

Configurable Models, Motor Voltages, & List Prices

Specify model motor voltage at time of order

Larkin Config Model	List Price by Motor Voltage (\$US)			Fan Config.
	208-230/3/60	460/3/60	575/3/60	
1/2" Diameter - Single Row Models				
FNHS01H301	12,982	12,982	13,356	1x1
FNHS01H402	16,596	16,596	16,970	1x1
FNHS02H203	20,713	20,713	21,459	1x2
FNHS02H304	25,068	25,068	25,814	1x2
FNHS02H405	31,431	31,431	32,177	1x2
FNHS03H306	39,097	39,097	40,217	1x3
FNHS03H407	44,356	44,356	45,476	1x3
FNHS04H308	50,623	50,623	52,114	1x4
FNHS04H409	57,962	57,962	59,453	1x4
FNHS05H310	66,527	66,527	68,392	1x5
FNHS05H411	76,820	76,820	78,685	1x5
1/2" Diameter - Double Row Models				
FNHD04H212	41,642	41,642	43,133	2x2
FNHD04H313	50,860	50,860	52,351	2x2
FNHD04H414	59,155	59,155	60,646	2x2
FNHD06H315	76,866	76,866	79,103	2x3
FNHD06H416	91,704	91,704	93,941	2x3
FNHD08H317	105,210	105,210	108,193	2x4
FNHD08H418	123,588	123,588	126,571	2x4
FNHD10H319	131,728	131,728	135,457	2x5
FNHD10H420	152,813	152,813	156,542	2x5
5/8" Diameter - Single Row Models				
FNHS03F301	45,673	45,673	46,793	1x3
FNHS03F402	53,125	53,125	54,245	1x3
FNHS04F303	60,166	60,166	61,657	1x4
FNHS04F404	70,575	70,575	72,066	1x4
FNHS05F305	78,323	78,323	80,188	1x5
FNHS05F406	92,361	92,361	94,226	1x5
FNHS06F307	97,571	97,571	99,808	1x6
FNHS06F408	108,576	108,576	110,813	1x6
5/8" Diameter - Double Row Models				
FNHD06F311	90669	90669	92906	2x3
FNHD06F412	109805	109805	112042	2x3
FNHD08F313	124383	124383	127366	2x4
FNHD08F414	148811	148811	151794	2x4
FNHD10F315	155317	155317	159046	2x5
FNHD10F416	183892	183892	187621	2x5
FNHD12F317	200701	200701	205175	2x6
FNHD12F418	222717	222717	227191	2x6

Notes:

For sizing and selection assistance, use Heatcraft software tool, THE HUB or contact your local Sales Representative or Account Engineer.



FNFC (FNH 1.5 HP 830 RPM MOTORS)

Need to Customize?

- Look on page FC-6 for factory-installed fan cycling, electrical, and mechanical options.
- Look on page FC-9 for condenser fin and coil protection options.

Configurable Models, Motor Voltages, & List Prices

Specify model motor voltage at time of order

Larkin Config Model	List Price by Motor Voltage (\$US)			Fan Config.
	208-230/3/60	460/3/60	575/3/60	
1/2" Diameter - Single Row Models				
FNLS01H321	13439	13439	13813	1x1
FNLS01H422	17175	17175	17549	1x1
FNLS02H223	21438	21438	22184	1x2
FNLS02H324	25943	25943	26689	1x2
FNLS02H425	32530	32530	33276	1x2
FNLS03H326	40465	40465	41585	1x3
FNLS03H427	45909	45909	47029	1x3
FNLS04H328	52397	52397	53888	1x4
FNLS04H429	59990	59990	61481	1x4
FNLS05H330	68856	68856	70721	1x5
FNLS05H431	79510	79510	81375	1x5
1/2" Diameter - Double Row Models				
FNLD04H232	43097	43097	44588	2x2
FNLD04H333	52640	52640	54131	2x2
FNLD04H434	61225	61225	62716	2x2
FNLD06H335	79557	79557	81794	2x3
FNLD06H436	94917	94917	97154	2x3
FNLD08H337	108893	108893	111876	2x4
FNLD08H438	127912	127912	130895	2x4
FNLD10H339	136336	136336	140065	2x5
FNLD10H440	158160	158160	161889	2x5
5/8" Diameter - Single Row Models				
FNLS03F321	47271	47271	48391	1x3
FNLS03F422	54984	54984	56104	1x3
FNLS04F323	62273	62273	63764	1x4
FNLS04F424	73046	73046	74537	1x4
FNLS05F325	81064	81064	82929	1x5
FNLS05F426	95594	95594	97459	1x5
FNLS06F327	100985	100985	103222	1x6
FNLS06F428	112378	112378	114615	1x6
5/8" Diameter - Double Row Models				
FNLD06F331	93844	93844	96081	2x3
FNLD06F432	113647	113647	115884	2x3
FNLD08F333	128736	128736	131719	2x4
FNLD08F434	154019	154019	157002	2x4
FNLD10F335	160753	160753	164482	2x5
FNLD10F436	190329	190329	194058	2x5
FNLD12F337	207726	207726	212200	2x6
FNLD12F438	230509	230509	234983	2x6

Notes:

For sizing and selection assistance, use Heatcraft software tool, THE HUB or contact your local Sales Representative or Account Engineer.



FNFC (FNH 1.5 HP 540 RPM MOTORS)

Need to Customize?

- Look on page FC-6 for factory-installed fan cycling, electrical, and mechanical options.
- Look on page FC-9 for condenser fin and coil protection options.

Configurable Models, Motor Voltages, & List Prices

Specify model motor voltage at time of order

Larkin Config Model	List Price by Motor Voltage (\$US)			Fan Config.
	208-230/3/60	460/3/60	575/3/60	
1/2" Diameter - Single Row Models				
FNQS01H341	12982	12982	-	1x1
FNQS01H442	16596	16596	-	1x1
FNQS02H243	20713	20713	-	1x2
FNQS02H344	25068	25068	-	1x2
FNQS02H445	31431	31431	-	1x2
FNQS03H346	39097	39097	-	1x3
FNQS03H447	44356	44356	-	1x3
FNQS04H348	50623	50623	-	1x4
FNQS04H449	57962	57962	-	1x4
FNQS05H350	66527	66527	-	1x5
FNQS05H451	76820	76820	-	1x5
1/2" Diameter - Double Row Models				
FNQD04H252	41642	41642	-	2x2
FNQD04H353	50860	50860	-	2x2
FNQD04H454	59155	59155	-	2x2
FNQD06H355	76866	76866	-	2x3
FNQD06H456	91704	91704	-	2x3
FNQD08H357	105210	105210	-	2x4
FNQD08H458	123588	123588	-	2x4
FNQD10H359	131728	131728	-	2x5
FNQD10H460	152813	152813	-	2x5
5/8" Diameter - Single Row Models				
FNQS03F341	45673	45673	-	1x3
FNQS03F442	53125	53125	-	1x3
FNQS04F343	60166	60166	-	1x4
FNQS04F444	70575	70575	-	1x4
FNQS05F345	78323	78323	-	1x5
FNQS05F446	92361	92361	-	1x5
FNQS06F347	97571	97571	-	1x6
FNQS06F448	108576	108576	-	1x6
5/8" Diameter - Double Row Models				
FNQD06F351	90669	90669	-	2x3
FNQD06F452	109805	109805	-	2x3
FNQD08F353	124383	124383	-	2x4
FNQD08F454	148811	148811	-	2x4
FNQD10F355	155317	155317	-	2x5
FNQD10F456	183892	183892	-	2x5
FNQD12F357	200701	200701	-	2x6
FNQD12F458	222717	222717	-	2x6

Notes:

For sizing and selection assistance, use Heatcraft software tool, THE HUB or contact your local Sales Representative or Account Engineer.



FNFC (FNH VSEC MOTORS)

Need to Customize?

- Look on page FC-6 for factory-installed fan cycling, electrical, and mechanical options.
- Look on page FC-9 for condenser fin and coil protection options.

Configurable Models, Motor Voltages, & List Prices

Specify model motor voltage at time of order

Larkin Config Model	List Price by Motor Voltage (\$US)			Fan Config.
	208-230/3/60	460/3/60	575/3/60	
1/2" Diameter - Single Row Models				
FNES01H361	25058	25058	-	1x1
FNES01H462	32030	32030	-	1x1
FNES02H263	39975	39975	-	1x2
FNES02H364	48378	48378	-	1x2
FNES02H465	60659	60659	-	1x2
FNES03H366	75460	75460	-	1x3
FNES03H467	85611	85611	-	1x3
FNES04H368	97704	97704	-	1x4
FNES04H469	111868	111868	-	1x4
FNES05H370	128401	128401	-	1x5
FNES05H471	148269	148269	-	1x5
1/2" Diameter - Double Row Models				
FNED04H272	80371	80371	-	2x2
FNED04H373	98162	98162	-	2x2
FNED04H474	114169	114169	-	2x2
FNED06H375	148354	148354	-	2x3
FNED06H476	176991	176991	-	2x3
FNED08H377	203056	203056	-	2x4
FNED08H478	238522	238522	-	2x4
FNED10H379	254232	254232	-	2x5
FNED10H480	294926	294926	-	2x5
5/8" Diameter - Single Row Models				
FNES03F361	88150	88150	-	1x3
FNES03F462	102531	102531	-	1x3
FNES04F363	116121	116121	-	1x4
FNES04F464	136207	136207	-	1x4
FNES05F365	151163	151163	-	1x5
FNES05F466	178258	178258	-	1x5
FNES06F367	188310	188310	-	1x6
FNES06F468	209554	209554	-	1x6
5/8" Diameter - Double Row Models				
FNED06F371	174994	174994	-	2x3
FNED06F472	211927	211927	-	2x3
FNED08F373	240060	240060	-	2x4
FNED08F474	287205	287205	-	2x4
FNED10F375	299764	299764	-	2x5
FNED10F476	354913	354913	-	2x5
FNED12F377	387354	387354	-	2x6
FNED12F478	429842	429842	-	2x6

Notes:

For sizing and selection assistance, use Heatcraft software tool, THE HUB or contact your local Sales Representative or Account Engineer.



OPTIONS PRICING - VSEC MODELS

Can't Find an Option?

Other options and accessories might be available on a custom order basis. Please contact your local Sales Representative or Account Engineer for assistance.

Factory-Installed Fan Cycling, Electrical, and Mechanical Options

- Motors are 208-230/3/60 or 460/3/60.
- Fused disconnect option is only available on units with an MOP of 60 or less. Please see accompanying technical specifications.

Option Code	Option Description	List Price Adder by Fan Configuration (US\$)										
		1x1	1x2	1x3	1x4	1x5	1x6	2x2	2x3	2x4	2x5	2x6
Fan Cycling Options												
FC.019	Proportional Lvg Fluid Temp Control	3,529	3,529	3,529	3,529	3,529	3,529	7,051	7,051	7,051	7,051	7,051
Electrical Options												
DISC.002	Fused Disconnect	386	772	1,158	1,544	1,930	2,316	1,544	2,316	3,088	3,860	4,632
MP.002	Individual Motor Fuses	386	772	1,158	1,544	1,930	2,316	1,544	2,316	3,088	3,860	4,632
MP.004	Paired Motor Fuses	-	-	-	-	-	-	772	1,158	1,544	1,930	2,316
MP.003	Individual Circuit Breakers (230V or 460V)	768	1,536	2,304	3,072	3,840	4,608	3,072	4,608	6,144	7,680	9,216
MP.005	Paired Circuit Breakers (230V or 460V)	-	-	-	-	-	-	1,536	2,304	3,072	3,840	4,608
MTB.001	Individual Motor Terminal Boards	270	540	809	1,046	1,349	1,618	1,082	1,616	2,157	2,698	3,236
MTB.002	Paired Motor Terminal Boards	-	-	-	-	-	-	540	809	1,077	1,349	1,618
Mechanical Options												
CM.003	Painted Cabinet w/ Side Access	-	-	-	-	-	-	-	-	-	-	-
CM.004	Galvanized Cabinet w/ Side Access	-427	-854	-1281	-1708	-2135	-2562	-1708	-2562	-3416	-4270	-5124
LEGS.002	Extended Legs, 30"	193	193	386	290	578	677	193	386	290	578	677
LEGS.003	Extended Legs, 36"	193	193	386	290	578	677	193	386	290	578	677
LEGS.004	Extended Legs, 42"	193	193	386	290	578	677	193	386	290	578	677
LEGS.005	Unit Frame, Std. Legs, 20"	2730	3937	5150	7377	8927	10646	3937	5150	7377	8927	10646
LEGS.006	Unit Frame, Ext. Legs, 42"	2919	4326	5730	8145	9889	11805	4326	5730	8145	9889	11805



OPTIONS PRICING - FNH/FNL/FNQ MODELS

Can't Find an Option?

Other options and accessories might be available on a custom order basis. Please contact your local Sales Representative or Account Engineer for assistance.

Factory-Installed Fan Cycling, Electrical, and Mechanical Options

- Fans are cycled in pairs on double wide units.
- Motor circuit breakers are not available on 575V units.
- Motor terminal boards are not available on units with fan cycling.
- When ordering toggle switch option, please specify whether switches are to be internally or externally mounted.
- Fused disconnect option is only available on units with an MOP of 60 or less. Please see accompanying technical specifications.
- Fan cycling kit does not include control circuit transformer. Optional factory installed control transformers are available to convert 460V or 575V main power supplies to 230V, 115V or 24V control power or 230V main power to 115V or 24V control power.

Option Code	Option Description	List Price Adder by Fan Configuration (US\$)										
		1x1	1x2	1x3	1x4	1x5	1x6	2x2	2x3	2x4	2x5	2x6
Fan Cycling Options (Must Select Fan Cycling and Contactor Option)												
FCC.004	Individual Motor Contactors: 230V, 115V, or 24V	386	772	1,158	1,544	1,930	2,316	1,544	2,316	3,088	3,860	4,632
FCC.001	Paired Motor Contactors: 230V, 115V, or 24V	-	-	-	-	-	-	773	1,159	1,545	1,931	2,318
FC.003	Lvg. Fluid Temperature Fan Cycling (Elec.)	2,710	3,294	5,218	7,137	9,065	10,561	3,294	5,218	7,137	9,065	10,561
Electrical Options												
CV.002	Control Circuit Transformer: 230V, 115V, or 24V	913	913	913	913	913	913	913	913	913	913	913
MP.002	Individual Motor Fuses	386	772	1,158	1,544	1,930	2,316	1,544	2,316	3,088	3,860	4,632
MP.004	Paired Motor Fuses	-	-	-	-	-	-	773	1,159	1,545	1,931	2,318
MP.003	Individual Circuit Breakers (230V or 460V)	768	1,536	2,304	3,072	3,840	4,608	3,072	4,608	6,144	7,680	9,216
MP.005	Paired Circuit Breakers (230V or 460V)	-	-	-	-	-	-	1,536	2,304	3,072	3,840	4,608
MTB.001	Individual Motor Terminal Boards	270	540	809	1,077	1,349	1,618	1,082	1,616	2,157	2,698	3,236
MTB.002	Paired Motor Terminal Boards	-	-	-	-	-	-	540	809	1,077	1,349	1,618
FCS.002	Fan Toggle Switches	162	323	481	642	804	966	642	966	1,290	1,611	1,924
FCS.004	Paired Fan Toggle Switches	-	-	-	-	-	-	323	481	642	804	966
DISC.002	Fused Disconnect	386	772	1,158	1,544	1,930	2,316	1,544	2,316	3,088	3,860	4,632
COND.002	Sealtite Wiring to Electrical Box	1,112	2,232	3,349	4,462	5,578	6,699	4,462	6,696	8,927	10,731	12,875
Mechanical Options												
CM.002	Aluminum Cabinet	427	854	1,281	1,708	2,135	2,562	1,708	2,562	3,416	4,270	5,124
CM.003	Pre-Painted Steel Cabinet	427	854	1,281	1,708	2,135	2,562	1,708	2,562	3,416	4,270	5,124
CM.004	Coil Access Panels, Galv	860	1,720	2,580	3,440	4,300	5,160	3,440	5,160	6,880	8,600	10,320
CM.005	Coil Access Panels, Aluminum	860	1,720	2,580	3,440	4,300	5,160	3,440	5,160	6,880	8,600	10,320
CM.006	Coil Access Panels, Painted Steel	860	1,720	2,580	3,440	4,300	5,160	3,440	5,160	6,880	8,600	10,320
VEN.002	Hinged Venturi	913	1,826	2,739	3,652	4,565	5,478	3,652	5,478	7,304	9,130	10,956
LEGS.002	Extended Legs, 30"	193	193	386	290	578	677	193	386	290	578	677
LEGS.003	Extended Legs, 36"	193	193	386	290	578	677	193	386	290	578	677
LEGS.004	Extended Legs, 42"	193	193	386	290	578	677	193	386	290	578	677
LEGS.005	Unit Frame, Std. Legs, 20"	2730	3937	5150	7377	8927	10646	3937	5150	7377	8927	10646
LEGS.006	Unit Frame, Ext. Legs, 42"	2919	4326	5730	8145	9889	11805	4326	5730	8145	9889	11805



CONNECTIONS OPTIONS - ALL MODELS

Can't Find an Option?

Other options and accessories might be available on a custom order basis. Please contact your local Sales Representative or Account Engineer for assistance.

Connections Options - All Models

Option Code	Row of Fans	Number of Feeds	Connection Size	List Price Adder (\$US)
Threaded Connection				
THD.020	1	9 - 18	2" MPT	691
THD.025	1	21-28	2-1/2" MPT	1,077
THD.030	1	42	3" MPT	1,839
THD.220	2	18 - 36	2" MPT	1,382
THD.225	2	42 - 56	2-1/2" MPT	2,159
THD.230	2	84	3" MPT	3,675
Flanged Connection				
FLG.020	1	9 - 18	2"	1,593
FLG.025	1	21 - 28	2-1/2"	1,839
FLG.030	1	42	3"	2,326
FLG.220	2	18 - 36	2"	3,222
FLG.225	2	42 - 56	2-1/2"	3,675
FLG.230	2	84	3"	4,653



COIL OPTIONS PRICING - ALL MODELS

Can't Find an Option?

Other options and accessories might be available on a custom order basis. Please contact your local Sales Representative or Account Engineer for assistance.

Condenser Fin and Coil Protection Options

Standard Fins Per Inch is 10. 8 FPI reduces the capacity of a model and 12 FPI and 14 FPI increase the capacity of a model.

Larkin Config Model	List Price Adders (\$US)						
	Fins Per Inch (FPI) Options				Coil Protection Options		
	8 FPI	10 FPI	12 FPI	14 FPI	Pro-Kote Fin Protection	Bronz-Glow Coating	Copper Fin Coil
Models with 1140 RPM (1.5HP) Motors - Single Row (1/2" Diameter)							
FNHS01H301	-643	Standard	643	1,290	1,498	6,976	7,094
FNHS01H402	-643	Standard	643	1,290	1,981	7,028	10,133
FNHS02H203	-1,285	Standard	1,285	2,586	2,016	10,062	10,133
FNHS02H304	-1,290	Standard	1,290	2,578	2,415	11,412	17,040
FNHS02H405	-1,290	Standard	1,290	2,578	3,923	11,890	23,029
FNHS03H306	-1,933	Standard	1,933	3,865	4,456	15,848	27,635
FNHS03H407	-1,933	Standard	1,933	3,865	6,360	16,889	38,690
FNHS04H308	-2,578	Standard	2,578	5,151	6,720	21,148	40,534
FNHS04H409	-2,578	Standard	2,578	5,151	8,962	21,803	47,900
FNHS05H310	-3,222	Standard	3,222	6,442	8,387	25,159	49,745
FNHS05H411	-3,222	Standard	3,222	6,442	11,182	26,574	63,561
Models with 1140 RPM (1.5HP) Motors - Double Row (1/2" Diameter)							
FNHD04H212	-2,572	Standard	2,572	5,173	4,024	20,122	21,187
FNHD04H313	-2,578	Standard	2,578	5,151	5,941	22,823	36,843
FNHD04H414	-2,578	Standard	2,578	5,151	7,851	23,778	50,666
FNHD06H315	-3,865	Standard	3,865	7,730	8,910	31,694	58,955
FNHD06H416	-3,865	Standard	3,865	7,730	12,718	33,777	82,051
FNHD08H317	-5,151	Standard	5,151	10,304	13,443	42,298	82,905
FNHD08H418	-5,151	Standard	5,151	10,304	17,922	43,608	99,029
FNHD10H319	-6,442	Standard	6,442	12,882	16,777	50,318	102,896
FNHD10H420	-6,442	Standard	6,442	12,882	22,371	53,151	132,651
Models with 1140 RPM (1.5HP) Motors - Single Row (5/8" Diameter)							
FNHS03F301	-1,933	Standard	1,933	3,865	4,456	15,848	27,635
FNHS03F402	-1,933	Standard	1,933	3,865	6,360	16,889	38,690
FNHS04F303	-2,578	Standard	2,578	5,151	6,720	21,148	40,534
FNHS04F404	-2,578	Standard	2,578	5,151	8,962	21,803	47,900
FNHS05F305	-3,222	Standard	3,222	6,442	8,387	25,159	49,745
FNHS05F406	-3,222	Standard	3,222	6,442	11,182	26,574	63,561
FNHS06F307	-3,865	Standard	3,865	7,730	11,747	28,638	73,003
FNHS06F408	-3,865	Standard	3,865	7,730	13,425	29,296	77,380
Models with 1140 RPM (1.5HP) Motors - Double Row (5/8" Diameter)							
FNHD06F311	-3,865	Standard	3,865	7,730	8,910	31,694	58,955
FNHD06F412	-3,865	Standard	3,865	7,730	12,718	33,774	82,051
FNHD08F313	-5,151	Standard	5,151	10,304	13,443	42,297	82,905
FNHD08F414	-5,151	Standard	5,151	10,304	17,922	43,608	99,029
FNHD10F315	-6,442	Standard	6,442	12,882	16,777	50,318	102,896



COIL OPTIONS PRICING - ALL MODELS

Can't Find an Option?

Other options and accessories might be available on a custom order basis. Please contact your local Sales Representative or Account Engineer for assistance.

Condenser Fin and Coil Protection Options

Standard Fins Per Inch is 10. 8 FPI reduces the capacity of a model and 12 FPI and 14 FPI increase the capacity of a model.

Larkin Config Model	List Price Adders (\$US)						
	Fins Per Inch (FPI) Options				Coil Protection Options		
	8 FPI	10 FPI	12 FPI	14 FPI	Pro-Kote Fin Protection	Bronz-Glow Coating	Copper Fin Coil
FNHD10F416	-6,442	Standard	6,442	12,882	22,371	53,151	132,651
FNHD12F317	-7,730	Standard	7,730	15,458	23,491	57,275	146,009
FNHD12F418	-7,730	Standard	7,730	15,458	26,851	58,688	162,128
Models with 830 RPM (1.5HP) Motors - Single Row (1/2" Diameter)							
FNLS01H321	-643	Standard	643	1,290	1,498	6,976	7,094
FNLS01H422	-643	Standard	643	1,290	1,981	7,028	10,133
FNLS02H223	-1,285	Standard	1,285	2,586	2,016	10,062	10,133
FNLS02H324	-1,290	Standard	1,290	2,578	2,415	11,412	17,040
FNLS02H425	-1,290	Standard	1,290	2,578	3,923	11,890	23,029
FNLS03H326	-1,933	Standard	1,933	3,865	4,456	15,848	27,635
FNLS03H427	-1,933	Standard	1,933	3,865	6,360	16,889	38,690
FNLS04H328	-2,578	Standard	2,578	5,151	6,720	21,148	40,534
FNLS04H429	-2,578	Standard	2,578	5,151	8,962	21,803	47,900
FNLS05H330	-3,222	Standard	3,222	6,442	8,387	25,159	49,745
FNLS05H431	-3,222	Standard	3,222	6,442	11,182	26,574	63,561
Models with 830 RPM (1.5HP) Motors - Double Row (1/2" Diameter)							
FNLD04H232	-2,572	Standard	2,572	5,173	4,024	20,122	21,187
FNLD04H333	-2,578	Standard	2,578	5,151	5,941	22,823	36,843
FNLD04H434	-2,578	Standard	2,578	5,151	7,851	23,778	50,666
FNLD06H335	-3,865	Standard	3,865	7,730	8,910	31,694	58,955
FNLD06H436	-3,865	Standard	3,865	7,730	12,718	33,774	82,051
FNLD08H337	-5,151	Standard	5,151	10,304	13,443	42,298	82,905
FNLD08H438	-5,151	Standard	5,151	10,304	17,922	43,608	99,029
FNLD10H339	-6,442	Standard	6,442	12,882	16,777	50,318	102,896
FNLD10H440	-6,442	Standard	6,442	12,882	22,371	53,151	132,651
Models with 830 RPM (1.5HP) Motors - Single Row (5/8" Diameter)							
FNLS03F321	-1,933	Standard	1,933	3,865	4,456	15,848	27,635
FNLS03F422	-1,933	Standard	1,933	3,865	6,360	16,889	38,690
FNLS04F323	-2,578	Standard	2,578	5,151	6,720	21,148	40,534
FNLS04F424	-2,578	Standard	2,578	5,151	8,962	21,803	47,900
FNLS05F325	-3,222	Standard	3,222	6,442	8,387	25,159	49,745
FNLS05F426	-3,222	Standard	3,222	6,442	11,182	26,574	63,561
FNLS06F327	-3,865	Standard	3,865	7,730	11,747	28,638	73,003
FNLS06F428	-3,865	Standard	3,865	7,730	13,425	29,296	77,380



COIL OPTIONS PRICING - ALL MODELS

Can't Find an Option?

Other options and accessories might be available on a custom order basis. Please contact your local Sales Representative or Account Engineer for assistance.

Condenser Fin and Coil Protection Options

Standard Fins Per Inch is 10. 8 FPI reduces the capacity of a model and 12 FPI and 14 FPI increase the capacity of a model.

Larkin Config Model	List Price Adders (\$US)						
	Fins Per Inch (FPI) Options				Coil Protection Options		
	8 FPI	10 FPI	12 FPI	14 FPI	Pro-Kote Fin Protection	Bronz-Glow Coating	Copper Fin Coil
Models with 830 RPM (1.5HP) Motors - Double Row (5/8" Diameter)							
FNLD06F331	-3,865	Standard	3,865	7,730	8,910	31,694	58,955
FNLD06F432	-3,865	Standard	3,865	7,730	12,718	33,774	82,051
FNLD08F333	-5,151	Standard	5,151	10,304	13,443	42,298	82,905
FNLD08F434	-5,151	Standard	5,151	10,304	17,922	43,608	99,029
FNLD10F335	-6,442	Standard	6,442	12,882	16,777	50,318	102,896
FNLD10F436	-6,442	Standard	6,442	12,882	22,371	53,151	132,651
FNLD12F337	-7,730	Standard	7,730	15,458	23,491	57,275	146,009
FNLD12F438	-7,730	Standard	7,730	15,458	26,851	58,688	162,128
Models with 540 RPM (0.5HP) Motors - Single Row (1/2" Diameter)							
FNQS01H341	-643	Standard	643	1,290	1,498	6,976	7,094
FNQS01H442	-643	Standard	643	1,290	1,981	7,028	10,133
FNQS02H243	-1,285	Standard	1,285	2,586	2,016	10,062	10,133
FNQS02H344	-1,290	Standard	1,290	2,578	2,415	11,412	17,040
FNQS02H445	-1,290	Standard	1,290	2,578	3,923	11,890	23,029
FNQS03H346	-1,933	Standard	1,933	3,865	4,456	15,848	27,635
FNQS03H447	-1,933	Standard	1,933	3,865	6,360	16,889	38,690
FNQS04H348	-2,578	Standard	2,578	5,151	6,720	21,148	40,534
FNQS04H449	-2,578	Standard	2,578	5,151	8,962	21,803	47,900
FNQS05H350	-3,222	Standard	3,222	6,442	8,387	25,159	49,745
FNQS05H451	-3,222	Standard	3,222	6,442	11,182	26,574	63,561
Models with 540 RPM (0.5HP) Motors - Double Row (1/2" Diameter)							
FNQD04H252	-2,572	Standard	2,572	5,173	4,024	20,122	21,187
FNQD04H353	-2,578	Standard	2,578	5,151	5,941	22,823	36,843
FNQD04H454	-2,578	Standard	2,578	5,151	7,851	23,778	50,666
FNQD06H355	-3,865	Standard	3,865	7,730	8,910	31,694	58,955
FNQD06H456	-3,865	Standard	3,865	7,730	12,718	33,774	82,051
FNQD08H357	-5,151	Standard	5,151	10,304	13,443	42,301	82,905
FNQD08H458	-5,151	Standard	5,151	10,304	17,922	43,608	99,029
FNQD10H359	-6,442	Standard	6,442	12,882	16,777	50,318	102,896
FNQD10H460	-6,442	Standard	6,442	12,882	22,371	53,151	132,651
Models with 540 RPM (0.5HP) Motors - Single Row (5/8" Diameter)							
FNQS03F341	-1,933	Standard	1,933	3,865	4,456	15,848	27,635
FNQS03F442	-1,933	Standard	1,933	3,865	6,360	16,889	38,690
FNQS04F343	-2,578	Standard	2,578	5,151	6,720	21,148	40,534



COIL OPTIONS PRICING - ALL MODELS

Can't Find an Option?

Other options and accessories might be available on a custom order basis. Please contact your local Sales Representative or Account Engineer for assistance.

Condenser Fin and Coil Protection Options

Standard Fins Per Inch is 10. 8 FPI reduces the capacity of a model and 12 FPI and 14 FPI increase the capacity of a model.

Larkin Config Model	List Price Adders (\$US)						
	Fins Per Inch (FPI) Options				Coil Protection Options		
	8 FPI	10 FPI	12 FPI	14 FPI	Pro-Kote Fin Protection	Bronz-Glow Coating	Copper Fin Coil
FNQS04F444	-2,578	Standard	2,578	5,151	8,962	21,803	47,900
FNQS05F345	-3,222	Standard	3,222	6,442	8,387	25,159	49,745
FNQS05F446	-3,222	Standard	3,222	6,442	11,182	26,574	63,561
FNQS06F347	-3,865	Standard	3,865	7,730	11,747	28,628	73,003
FNQS06F448	-3,865	Standard	3,865	7,730	13,425	29,296	77,380
Models with 540 RPM (0.5HP) Motors - Double Row (5/8" Diameter)							
FNQD06F351	-3,865	Standard	3,865	7,730	8,910	31,694	58,955
FNQD06F452	-3,865	Standard	3,865	7,730	12,718	33,774	82,051
FNQD08F353	-5,151	Standard	5,151	10,304	13,443	42,298	82,905
FNQD08F454	-5,151	Standard	5,151	10,304	17,922	43,608	99,029
FNQD10F355	-6,442	Standard	6,442	12,882	16,777	50,318	102,896
FNQD10F456	-6,442	Standard	6,442	12,882	22,371	53,151	132,651
FNQD12F357	-7,730	Standard	7,730	15,458	23,491	57,275	146,009
FNQD12F458	-7,730	Standard	7,730	15,458	26,851	58,688	162,128
Models with VSEC Motors - Single Row (1/2" Diameter)							
FNES01H361	-643	Standard	643	1,290	1,498	6,976	7,094
FNES01H462	-643	Standard	643	1,290	1,981	7,028	10,133
FNES02H263	-1,285	Standard	1,285	2,586	2,016	10,062	10,133
FNES02H364	-1,290	Standard	1,290	2,578	2,415	11,412	17,040
FNES02H465	-1,290	Standard	1,290	2,578	3,923	11,890	23,029
FNES03H366	-1,933	Standard	1,933	3,865	4,456	15,848	27,635
FNES03H467	-1,933	Standard	1,933	3,865	6,360	16,889	38,690
FNES04H368	-2,578	Standard	2,578	5,151	6,720	21,148	40,534
FNES04H469	-2,578	Standard	2,578	5,151	8,962	21,803	47,900
FNES05H370	-3,222	Standard	3,222	6,442	8,387	25,159	49,745
FNES05H471	-3,222	Standard	3,222	6,442	11,182	26,574	63,561
Models with VSEC Motors - Double Row (1/2" Diameter)							
FNED04H272	-2,572	Standard	2,572	5,173	4,024	20,122	21,187
FNED04H373	-2,578	Standard	2,578	5,151	5,941	22,823	36,843
FNED04H474	-2,578	Standard	2,578	5,151	7,851	23,778	50,666
FNED06H375	-3,865	Standard	3,865	7,730	8,910	31,694	58,955
FNED06H476	-3,865	Standard	3,865	7,730	12,718	33,774	82,051
FNED08H377	-5,151	Standard	5,151	10,304	13,443	42,298	82,905
FNED08H478	-5,151	Standard	5,151	10,304	17,922	43,480	99,029
FNED10H379	-6,442	Standard	6,442	12,882	16,777	50,318	102,896
FNED10H480	-6,442	Standard	6,442	12,882	22,371	53,151	132,651



COIL OPTIONS PRICING - ALL MODELS

Can't Find an Option?

Other options and accessories might be available on a custom order basis. Please contact your local Sales Representative or Account Engineer for assistance.

Condenser Fin and Coil Protection Options

Standard Fins Per Inch is 10. 8 FPI reduces the capacity of a model and 12 FPI and 14 FPI increase the capacity of a model.

Larkin Config Model	List Price Adders (\$US)						
	Fins Per Inch (FPI) Options				Coil Protection Options		
	8 FPI	10 FPI	12 FPI	14 FPI	Pro-Kote Fin Protection	Bronz-Glow Coating	Copper Fin Coil
Models with VSEC Motors - Single Row (5/8" Diameter)							
FNES03F361	-1,933	Standard	1,933	3,865	4,456	15,848	27,635
FNES03F462	-1,933	Standard	1,933	3,865	6,360	16,889	38,690
FNES04F363	-2,578	Standard	2,578	5,151	6,720	21,148	40,534
FNES04F464	-2,578	Standard	2,578	5,151	8,962	21,803	47,900
FNES05F365	-3,222	Standard	3,222	6,442	8,387	25,159	49,745
FNES05F466	-3,222	Standard	3,222	6,442	11,182	26,574	63,561
FNES06F367	-3,865	Standard	3,865	7,730	11,747	28,638	73,003
FNES06F468	-3,865	Standard	3,865	7,730	13,425	29,296	77,380
Models with VSEC Motors - Double Row (5/8" Diameter)							
FNED06F371	-3,865	Standard	3,865	7,730	8,910	31,694	58,955
FNED06F472	-3,865	Standard	3,865	7,730	12,718	33,774	82,051
FNED08F373	-5,151	Standard	5,151	10,304	13,443	42,298	82,905
FNED08F474	-5,151	Standard	5,151	10,304	17,922	43,608	99,029
FNED10F375	-6,442	Standard	6,442	12,882	16,777	50,318	102,896
FNED10F476	-6,442	Standard	6,442	12,882	22,371	53,151	132,651
FNED12F377	-7,730	Standard	7,730	15,458	23,491	57,275	146,009
FNED12F478	-7,730	Standard	7,730	15,458	26,851	58,688	162,128



SHIPPED-LOOSE ACCESSORIES

Can't Find An Option or Accessory?

Other options and accessories might be available on a custom order basis. Please contact your local Sales Representative or Account Engineer for assistance.

Connection Manifold Kits

Fluid cooler manifolds are for converting standard two circuit fluid coolers to single circuit. Price includes all tube fittings for field brazing to inlet and outlet.

Feeds	Part Number	List Price (\$US)	Inlet		Outlet	
			Qty	Size	Qty	Size
18	MANF18	2,616	2	2-1/8"	1	4-1/8"
28	MANF28	2,616	2	2-1/8"	1	4-1/8"
36	MANF36	2,616	2	2-1/8"	1	4-1/8"
42	MANF42	4,482	2	2-5/8"	1	4-1/8"
56	MANF56	4,482	2	2-5/8"	1	4-1/8"
84	MANF84	5,932	2	3-1/8"	1	4-1/8"
112	MANF112	5,932	2	3-1/8"	1	4-1/8"



FLUID COOLERS

Small Fluid Coolers

Direct-drive fluid coolers, available in horizontal or vertical airflow, are ideal for commercial/industrial locations. Available in sizes 5 to 26 tons, these units are easy to install and maintain. Specifically engineered for outdoor installations, the cabinet is constructed of heavy gauge aluminum to resist corrosion in all climates.

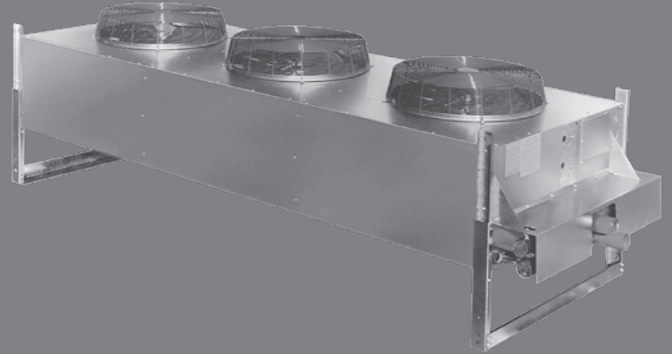

NOMENCLATURE



PFG	14
Product Line	Size
Direct Drive Fluid Cooler	Model

OVERVIEW

STANDARD FEATURES

Ease of Installation & Service

- Completely assembled and tested at the factory
- All fan motor leads are wired to a weatherproof electrical enclosure for single-point field wiring

Reliable & Durable

- Cabinets are heavy-duty construction and designed for outdoor applications; tube sheets and all structural members are fabricated from galvanized steel
- Cabinet panels are fabricated from heavy-gauge aluminum for an attractive appearance and corrosion protection
- Coils are fabricated with corrugated aluminum fins with staggered copper tubes for optimum heat transfer; all units are pressure-tested, dehydrated and pressurized prior to shipment
- Balanced fans, featuring heavy gauge aluminium blades riveted to plated steel spiders
- Corrosion resistant fan blades and guards
- Fan guards are coated steel for optimum corrosion protection
- Wide fin spacing minimizes fouling from foreign materials
- Fan motors have thermal overload protection and permanently lubricated ball bearings

Performance

- Fully baffled fan sections provide structural strength and prevent fan wind-milling in the off cycle
- Coils are the patented cross-fin coil with staggered seamless copper tubes expanded into full collar aluminum fins for high heat transfer efficiency

Versatile

- Available in horizontal or vertical airflow
- Sizes available from 10 GPM through 160 GPM
- A wide selection of circuit options maximizes performance at minimal cost



CONFIGURABLE MODELS & OPTIONS PRICING

Configurable Models, Factory-Installed Options, & List Prices

- Specify model motor voltage and type at time of order. 208-230/1/60 motors may be field connected to 230/3/60 power.
- Standard Control Circuit Voltage is 230V unless otherwise specified. 24V & 115V are available at no additional cost. Specify control circuit voltage when ordering.
- Fan cycling pricing does not include control circuit transformer for 460V or 575V units. If needed, transformer can be ordered from ship-loose accessories.

Larkin Config Model	List Price (\$US)	Fan Config.	Factory-Installed Options List Price Adders (\$US)			
			Fan Cycling Options		Coil Coatings	
			1 PH Amb.	3 PH Amb.	ProKote™ Coated Fins	Bronz-Glow or ElectroFin
208-230/1/60 with PSC Motors						
PFG5	9,369	1x1	-	-	553	4,612
PFG8	11,833	1x1	-	-	880	4,612
PFG10	14,463	1x2	850	-	992	6,904
PFG12	16,240	1x2	850	-	1,094	6,904
PFG14	18,574	1x2	850	-	1,321	9,208
PFG16	20,358	1x2	850	-	1,618	10,551
PFG21	23,471	1x3	1,181	-	1,795	13,813
PFG23	24,133	1x3	1,181	-	2,044	13,813
PFG26	26,352	1x3	1,181	-	2,487	13,813
208-230/3/60 with Polyphase Motors						
PFG5	9,923	1x1	-	-	553	4,612
PFG8	12,265	1x1	-	-	880	4,612
PFG10	15,519	1x2	-	2,136	992	6,904
PFG12	17,110	1x2	-	2,136	1,094	6,904
PFG14	19,442	1x2	-	2,136	1,321	9,208
PFG16	21,228	1x2	-	2,136	1,618	10,551
PFG21	24,786	1x3	-	2,638	1,795	13,813
PFG23	25,445	1x3	-	2,638	2,044	13,813
PFG26	27,659	1x3	-	2,638	2,487	13,813
460/3/60 with Polyphase Motors						
PFG5	9,923	1x1	-	-	553	4,612
PFG8	12,265	1x1	-	-	880	4,612
PFG10	15,519	1x2	-	2,136	992	6,904
PFG12	17,110	1x2	-	2,136	1,094	6,904
PFG14	19,442	1x2	-	2,136	1,321	9,208
PFG16	21,228	1x2	-	2,136	1,618	10,551
PFG21	24,786	1x3	-	2,638	1,795	13,813
PFG23	25,445	1x3	-	2,638	2,044	13,813
PFG26	27,659	1x3	-	2,638	2,487	13,813
575/3/60 with Polyphase Motors						
PFG5	10,570	1x1	-	-	553	4,612
PFG8	12,909	1x1	-	-	880	4,612
PFG10	16,807	1x2	-	2,136	992	6,904
PFG12	18,401	1x2	-	2,136	1,094	6,904
PFG14	20,733	1x2	-	2,136	1,321	9,208
PFG16	22,516	1x2	-	2,136	1,618	10,551
PFG21	26,723	1x3	-	2,638	1,795	13,813
PFG23	27,378	1x3	-	2,638	2,044	13,813
PFG26	29,594	1x3	-	2,638	2,487	13,813

Notes:

- For selection or sizing assistance, use Heatcraft software tool, THE HUB or contact your local your Sales Representative or Account Engineer.
- Copper Fin Coils are available. Contact your Sales Representative or Account Engineer for more information.
- Must specify which coating at time of order entry.



SHIPPED-LOOSE ACCESSORIES

Can't Find An Option or Accessory?

Other options and accessories might be available on a custom order basis. Please contact your local Sales Representative or Account Engineer for assistance.

Part Number	Description	Models Used On	List Price (\$US)	Notes
8990065	Expansion tank and mounting kit	ALL	1,070	12x24 horizontal tank, 12 gallon, 30 PSIG, non-ASME
R038253919	Control Circuit Transformer	ALL	977	-



REFRIGERATION CONTROLS AND TECHNOLOGY

intelliGen™ Refrigeration Controller



SYSTEM OVERVIEW

intelliGen Refrigeration Controller (iRC):

The iRC is a factory mounted electronic control solution for evaporators that provides automatic superheat, room temperature and intelligent defrost control capability for walk-in coolers and freezers. The iRC provides superior system performance and energy savings over traditional electro-mechanical controls commonly used on refrigeration equipment today.

intelliGen Webserver Card (iWC):

The iWC is an Optional Component to the iRC and it enables local and remote control and monitoring of your refrigeration system on any smart device (Phone, Tablet, PC). You need only ONE iWC per system (Up to 8 Connected Evaporators, 1 Condensing Unit)

intelliGen Integration Card (iIC):

The iIC is an Optional Component to the iRC and it enables connectivity to the Building Management system via BACnet or Modbus. You need ONE iIC per system (Up to 8 Connected Evaporators, 1 Condensing Unit)

Eliminated Components:

- Liquid-line solenoid valve
- Room thermostat
- Thermal expansion valve
- Defrost time clock
- Defrost termination/fan delay switch
- Defrost and fan contactors

Pricing (one Card Required PER SYSTEM):

Part Name	Part Number List	Price (\$US)
intelliGen Webserver Card (iWC)	28918301S	1,141
intelliGen Integration Card (iIC)	28918401S	660



REFRIGERATION CONTROLS AND TECHNOLOGY

intelliGen™ Refrigeration Controller Universal Field-Mount Refrigeration Controller

iFM Universal Field-Mount Refrigeration Controller with temperature sensors and pressure transducer kit

The intelliGen™ Field Mount (iFM) Kit is designed to install in the field for new unit coolers without factory mounted controls or retrofit of existing unit coolers with mechanical control to utilize the latest electronic control technology for refrigeration.



Pre-assembled hardware in durable water resistant case

40ft

Remote mount up to 40ft from equipment



IP65 rated for indoor and outdoor applications



intelliGen Features & Benefits

Intuitive design

- Light Bar with Alerts immediately shows system status
- Guided text with instruction, No coded display to decipher.
- Quick menu buttons to change settings and changes.

Simple setup

- Guided quick setup.
- “No wiring between condensing unit and unit cooler, when controlling unit cooler only.”
- Set Up In Minutes, Not Hours

Smart servicing

- Remote monitoring capability with webserver card added.
- Receive alerts via web, text, BMS & E-mail.
- 60 days of onboard storage with USB port for data download.
- Easy maintenance (Wires are labeled, removable color coded terminals)

Part Number	Description	List Price (US\$)
59755002	intelliGen Field Mount (iFM) Kit with 25ft sensor lead wires	\$2,600



REFRIGERATION CONTROLS AND TECHNOLOGY

intelliGen™ Refrigeration Controller Multi-system Control with Lead Lag (MSC)

Organize and control multiple systems through a single remote interface with this simple-to-install MSC Card. Create lead-lag zones to set up system redundancy to prevent potential product loss. Balance systems' run time to extend equipment life.

32

Multiple systems control up to 32 systems

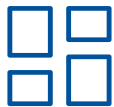

Organize systems into sections and zones for better management



Lead-lag control up to 4 systems in a single zone



Wi-Fi Direct with antenna included



Single dashboard provides a summary view of all systems



Add-in option, install in place of webserver card for remote monitoring



Smart Servicing with MSC Card

- Enable redundant systems setup to reduce urgent service calls.
- “Out-of-the-box” Wi-Fi Direct support with antenna included.
- Easy access to system without the need of climbing ladder with Wi-Fi Direct.
- Intuitive, graphic rich webserver pages for easy configuration and management.
- Remote monitoring to diagnose systems prior to site visit.



Part Number	Description	List Price (US\$)
28918302S	Multi-system Control (MSC) with Lead-lag Card Field Mount Kit	\$1,575



REFRIGERATION CONTROLS AND TECHNOLOGY

intelliGen™ Refrigeration Controller Retrofit Kits for Beacon II and QRC Controls

intelliGen™ retrofit kits unite your existing Heatcraft Beacon II™ Refrigeration Controller or Quick Response Controller™ (QRC) systems into ONE smart, intuitive control platform.



"Plug-n-Play", retrofit in less than 30 minutes.



Simple setup with intelliGen™ Quick Start

ONE

The Power of ONE platform, easy to maintain and operate



Model Family	Defrost Type	Voltage/Phase	Model Size	Color Finish	Retrofit Kit Part #	List Price	
Low Profile (LOP)	Air & Electric	115/1 208-230/1	All	Stucco	89730101	\$2,200	
				White	89730102	\$2,200	
Center Mount (CM) Low Velocity Center Mount (LVCM)	Air & Electric	115/1 208-230/1	CM: All ¹ LVCM: 050/075 ²	Stucco	89730201	\$2,200	
				White	89730202	\$2,200	
			LVCM: 100 ²	Stucco	89730205	\$2,200	
				White	89730206	\$2,200	
				Stucco	89730209	\$2,200	
				White	89730210	\$2,200	
Medium Profile (MP)	Air	115-230/1	All	Stucco	89730301	\$2,300	
				White	89730302	\$2,300	
		460/1		Stucco	89730303	\$2,300	
				White	89730304	\$2,300	
	Electric	208-230/3	All	Stucco	89730305	\$2,300	
				White	89730306	\$2,300	
		208-230/3 with >30A Heater ³		Stucco	89730307	\$2,300	
				White	89730308	\$2,300	
		460/3		Stucco	89730309	\$2,300	
				White	89730310	\$2,300	
Large Unit Cooler (LUC)	Air	230-460/1	Plain Aluminum		89730401	\$2,500	
					89730402	\$2,500	
		230-575/3			89730403	\$2,500	
					89730404	\$2,500	
		Electric		230-460/1		89730405 ⁴	\$5,000
						89730406	\$2,500
	208-230/3				89730407	\$2,500	
					89730408	\$2,500	
	460/3				89730409	\$2,500	
					89730410	\$2,500	
	575/3				89730411	\$2,500	
					89730412	\$2,500	
		89730413		\$2,500			
		89730414 ⁴		\$5,000			

- Notes:**
- Center Mount unit cooler models use 89730201 or 89730202 kit part numbers only.
 - Low Velocity Center Mount unit cooler models are based on the capacity digits in the model number for the kit size and part number.
 - Medium Profile unit coolers have greater than 30 Amp draw with large defrost heaters use kit part number 89730307 and 89730308.
 - Part number 89730405 and 89730414 have two intelliGen controls for dual circuited LUCs.

Unit mounted intelliGen is not available for Low Profile models with 208-230/3/60 and 460/1/60, and not available for Low Velocity Center Mount models with 460/1/60. intelliGen Field Mount (IFM) kit could be used for these models. Ask Heatcraft sales representatives for details.



REFRIGERATION CONTROLS AND TECHNOLOGY

intelliGen™ Refrigeration Controller Shipped Loose or Service Parts

Type	Description	Part#	List Price
Field Mount Kit	intelliGen Field Mount (IFM) Kit with 25ft sensor lead wires	59755002	\$2,600
Power Harness	15ft harness for power, fan, defrost heater, solenoid valve	22699903	\$500
	25ft harness for power, fan, defrost heater, solenoid valve	22699902	\$830
	40ft harness for power, fan, defrost heater, solenoid valve	22699901	\$1,230
Temperature Sensors	Temperature Sensor Kit - White Leads, 3ft	89904903	\$77
	15ft sensor kit (3 temperature sensors, 1 pressure transducer harness)	59755302	\$270
	40ft sensor kit (3 temperature sensors, 1 pressure transducer harness)	59755301	\$390
Pressure Transducer & Harnesses	Pressure Transducer 0 - 300 PSIA	28911202	\$356
	Pressure Transducer Harness, 15ft	22515107	\$110
	Pressure Transducer Harness, 40ft	22515105	\$190
Transformers	Transformer 120/24 volt - 40 VA	22529601	\$113
	Transformer 240/24 volt - 40 VA	22529602	\$114
	Transformer 460/24 - 40 VA	22529603	\$139
	Transformer 575/24 - 40 VA	22529701	\$191
Electronic Expansion Valve (EXV) & Cables	Carel EXV E2V11FWAE0 - 3/8" x 3/8" Conn	29326101	\$1,226
	Carel EXV E2V24FWAE0 - 3/8" x 3/8" Conn	29326201	\$1,226
	Carel EXV E2V24FSME0 - 5/8" X 5/8" Conn	29326401	\$1,226
	Carel EXV E3V45ASTE0 - 7/8" X 1 3/8" Conn	29326501	\$2,409
	Carel EXV E3V55ASTE0 - 7/8" X 1 3/8" Conn	29326601	\$2,409
	Cable for Carel EXV, 10ft	22592201	\$146
	Cable for Carel EXV, 25ft	22592103	\$260
	Cable for Carel EXV, 40ft	22592102	\$320
Control Boards	iRC Main Control Board Replacement Kit	28918001S	\$1,250
	iRCUI User Interface Replacement Kit	28918201S	\$846
	iWC Webserver Card Replacement Kit	28918301S	\$1,108
	Multi-system Control (MSC) with Lead-lag Card Field Mount Kit	28918302S	\$1,575
	iIC Integration Card Replacement Kit	28918401S	\$641
UI to iRC Ribbon Cables	For Center Mount/Low Velocity Center Mount Unit Cooler, 8" Replacement Kit	22602101	\$157
	For Low Profile Unit Cooler, 14" Replacement Kit	22602102	\$309
	For Medium Profile and Large Unit Cooler, 24" Replacement Kit	22602104	\$467
	For Large Unit Cooler 35" Replacement Kit	22602103	\$621
EV-COM Cable	EV-COM Cable 28" for Large Unit Cooler DUAL iRC Board Replacement Kit	22596801	\$777
Door Switch	Door Switch Kit (includes door switch and 2 ft cable)	22543102	\$287



REFRIGERATION CONTROLS AND TECHNOLOGY

HyperCore™ Microchannel Coils

HyperCore™ microchannel condenser coils, a standard feature on the ½ - 6 HP air-cooled condensing units, are all-aluminum coils with multiple flat tubes containing small channels (microchannels) through which refrigerant flows. Heat transfer is maximized by the insertion of angled and louvered fins inbetween the flat tubes. These components are joined with two refrigerant manifolds using an aluminum-zinc alloy brazing material in a nitrogen-charged braze furnace to make the completed microchannel coil.

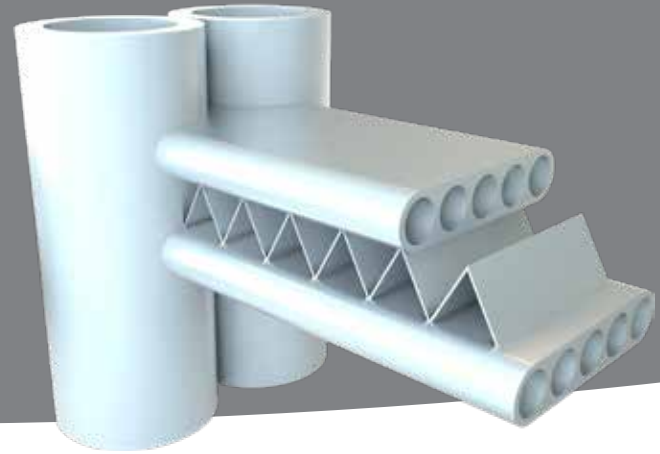

GENERAL INFORMATION

FEATURES AND BENEFITS

Improved Heat Transfer Performance

- 20-30% higher than traditional copper-aluminum round-tube plate fin (RTPF) coils with epoxy coating of the same size, enabling comparable capacity achievement with a smaller coil

Improved Corrosion Protection

- Monometal (aluminum) construction gives no opportunity for galvanic corrosion – HyperCore™ microchannel coils have been proven to last up to two times (2X) longer than standard RTPF coils in extended tests

Reduced Refrigerant Charge & Reduced Costs

- Condenser coil refrigerant charge may be reduced by up to 75%, leading to as much as a 40% reduction in system charge and reducing costs for end users

Improved Durability & Reduced Potential for Leaks

- Require only one manual braze operation versus 50-100 manually brazed joints for RTPF, significantly reducing the likelihood for leaks
- Flat tubes serve as a fin guard to help protect the fins from damage

Environmentally Friendly

- 100% recyclable
- Reduced refrigerant helps decrease the potential for ozone depletion and global warming



REFRIGERATION CONTROLS AND TECHNOLOGY

Remote Refrigeration Control

The Remote Refrigeration Control, perfect for both foodservice and cold storage applications, is a web based remote monitoring and control service offering that provides instant access 24/7 to real time refrigeration system status and information. Heatcraft is proud to offer the most advanced commercial refrigeration system monitoring package available in the industry. The Remote Refrigeration Control is compatible with both the Beacon II™ Refrigeration System and the Mohave™ Advanced Hot Gas Defrost System.

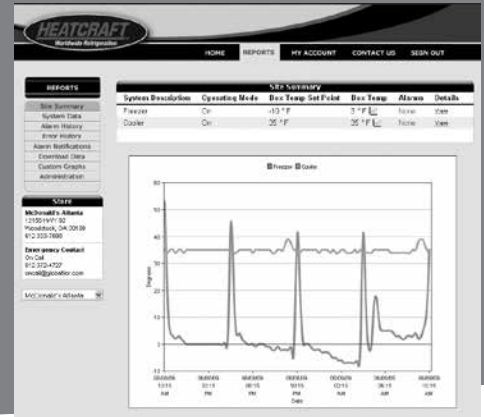

GENERAL INFORMATION

FEATURES AND BENEFITS

Securely Manage Your Beacon II Refrigeration Systems From Any Web Enabled Device 24/7

- Monitor and control the Beacon II refrigeration system(s) at one or more sites through a single website
- Secure login with multiple user level profiles and access rights

Improve System Efficiency & Reliability

- Real-time system information and advanced reporting/graphing capabilities provide you the tools necessary to keep your system running at peak performance

Increase Product Integrity & Service Call Effectiveness

- System Alarm Alerts sent 24/7 via e-mail or SMS text message notify you promptly of refrigeration system alarm conditions
- Remote troubleshooting capability improves first call resolution by providing refrigeration system data to the user

Strengthen Food Safety Compliance Programs

- Data-logging, advanced reporting capabilities, and alarm notification capabilities help comply with FDA and USDA HACCP food safety requirements

A Service Package That Meets Your Needs

- Collect and display 40+ datapoints from your Beacon II refrigeration system in real-time

RRC normally connects to all DHCP IP internet connections. If your site is Static IP, Mohave, or is highly secure, IT personnel may be required to be on site.

For more information, please contact your local Sales Representative or Account Engineer.



REFRIGERATION CONTROLS AND TECHNOLOGY

Lead Lag Temperature Controller

The Lead Lag Temperature Controller provides an integrated thermostat and staging control for cold rooms with multiple refrigeration systems. Lead Lag Temperature Controller are available for 2 to 4 systems and utilize predictive control algorithms to increase systems reliability and energy efficiency. The Lead Lag Temperature Controller is compatible with both conventional refrigeration systems and Mohave Advanced Hot Gas Defrost Systems.

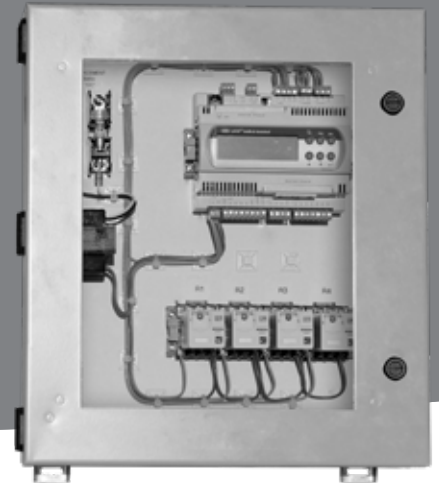

GENERAL INFORMATION

FEATURES AND BENEFITS

- Controls from 2 to 4 systems
- Integrated thermostat with multiple temperature sensor capability
- Controls both conventional and Mohave refrigeration systems
- Suitable for either 100% redundant or split load applications
- Alarm capability for High and Low Temperature, Controller Power Loss and Temperature Sensor Failure
- Predictive control algorithm utilizing Output Time or FIFO control strategies to equalize system run times
- Compressor run and staging timers
- User friendly interface
- Increased system reliability
- Energy efficient

Cat #	Number of Controlled System	List Price (\$US)
LLT42	2	8,812
LLT43	3	9,381
LLT44	4	10,431

Temperature Sensors

Cat #	List Price (\$US)
28988042	129

Note: LLT units include one temperature sensor. Any additional sensors must be ordered as a separate item.



OTHER PRODUCTS & SERVICES

Air-Cooled Package Chiller

The ACC air-cooled process chiller product family is an important addition to the Heatcraft line of process cooling equipment. ACC chillers are designed to provide an efficient and reliable solution for a variety of process cooling applications. Units feature compact, high efficiency braze plate evaporators for improved heat transfer, advanced microprocessor controllers for optimized operation, and floating tube condenser coils for enhanced refrigerant leak protection. ACC air-cooled process chillers provide owners with dependable cooling for critical applications.



NOMENCLATURE

ACC	Z	000	C	6	S	—
Model	Compressor Type	Nominal Capacity	Voltage	Refrigerant	# of Compressors	Pump/Tank Options
Air-Cooled Chiller	Z = Scroll R = Reciprocating	005 - 080 = XXX tons	C = 208-230/3/60 D = 460/3/60 E = 575/3/60	6 = R-404A 7 = R-407C	S = Single D = Dual	Blank = Chiller Only P = Pump Only T = Pump/Integral Tank

OVERVIEW

STANDARD FEATURES

- Heated and insulated stainless steel braze plate evaporator.
- Floating Tube condenser coil design. Refrigerant carrying copper tubes do not contact any metal support sheets. Expanded anchor tubes support the coil and do not carry refrigerant. This coil design eliminates one of the major causes of leaks in chiller systems. Coil includes a 5 year leak warranty at tube sheets and center supports.
- Thermally protected condenser fan motors with permanently lubricated ball bearings
- Adjustable two valve head pressure control system with drain line check valve per circuit
- Liquid receiver with inlet and outlet service valves and pressure relief valve per circuit
- Suction accumulator per circuit
- Liquid line filter drier, moisture indicator/sight glass, solenoid valve and thermal expansion valve per circuit.
- Hot gas bypass capacity control system per circuit
- ETL listed control panel with microprocessor controller, 24V control transformer, compressor and condenser fan contactors and phase loss monitor

Models with Scroll Compressors (ACCZ Models)

- Scroll compressor with suction and discharge valves, and crankcase heater per circuit.

Models with Reciprocating Compressors (ACCR Models)

- Spring mounted semi-hermetic reciprocating compressor with suction and discharge service valves, suction and discharge vibration eliminators, and crankcase heater per circuit

Typical Applications Include:

- Machining (Cutting, Welding)
- Printing
- Plastic Molding
- Brewing
- Concrete Mixing
- Additional Industrial Processes

For more information, please contact your local Sales Representative or Account Engineer.



OTHER PRODUCTS & SERVICES

Screw Compressor Condensing Units

The screw compressor condensing unit is an important addition to the Heatcraft air-cooled condensing unit product family, featuring innovative compact screw compressors and advanced microprocessor controls. The unit is designed to provide increased system reliability, reduced installation and operation costs, as well as, improved product integrity in commercial and industrial refrigeration applications.



NOMENCLATURE

S	S	V	000B	M	6	D
Number of Circuits	Compressor	Airflow	Equiv. HP	Temp. Range	Refrigerant	Voltage
S = Single D = Dual	S = Screw	V = Vertical	050B = 50 060B = 60 070B = 70 080B = 80 090B = 90 100B = 100 110B = 110 125B = 125 140B = 140	M = Medium H = High	6 = R404A/507 7 = R-407	D = 460/3/60 E = 575/3/60

OVERVIEW

STANDARD FEATURES

Increased Reliability

- Fewer moving parts result in improved durability
- Semi-hermetic motor design eliminates shaft seal and coupling concerns
- Integral oil system provides improved lubrication performance
- Factory-equipped microprocessor control system guarantees safe, reliable system performance
- Floating tube condenser coil design minimizes potential for refrigerant leaks

Reduced Costs of Ownership

- More capacity per compressor reduces number of compressors on large projects
- Reduced installation time and cost savings
- Built-in features include soft starting, slide valve unloading and digital controls for minimized operating costs

Improved Product Integrity

- Advanced digital controls and variable capacity capability maintain more precise temperature control
- Minimal temperature fluctuations result in maximum product integrity
- Advanced diagnostic, monitoring and data logging options allow for quick system recovery

For more information, please contact your local Sales Representative or Account Engineer.



OTHER PRODUCTS & SERVICES

Commercial Financing



Commercial Financing

OVERVIEW

FINANCIAL SOLUTIONS MADE EASY

What if you could bundle everything you need, including new energy efficient commercial refrigeration equipment, control systems, installation services, maintenance programs and extended warranties, into a convenient and affordable monthly payment in less than 24 hours? Heatcraft Commercial Financing provides greater financial convenience with custom-fit financing solutions to perfectly meet your company's purchasing needs.

When you finance through Heatcraft Commercial Financing, you also get these additional benefits:

- Easy, streamlined application process
- Fast approval process, with most decisions made within 2-6 business hours
- Financing for your entire commercial refrigeration purchase, from equipment and installation to monitoring and maintenance programs
- Deferred and structured payments to assist with financial planning and budgeting
- Tax incentives and rebates that you may qualify for when you finance/lease your purchase

Contact Heatcraft Commercial Financing today to learn more about financing options that work best for your short-term needs and long-term plans.



OTHER PRODUCTS & SERVICES

Mohave™ Advanced Hot Gas Defrost System

Mohave™ Advanced Hot Gas Defrost System is a heat pump based design consisting of a vertical discharge condensing unit matched to one or two evaporators, medium profile or large unit coolers. Featuring a state-of-the-art electronic defrost controller, the system operates in all outdoor ambient temperatures (tested to -20°F) and uses a proprietary control scheme to automatically adjust to changing conditions so that the system continues to operate at its most optimal level. The Mohave™ Advanced Hot Defrost System is designed for simplicity and optimal performance for use in agricultural, process cooling, cold storage and warehouse applications.



6 - 40 HP SPLIT SYSTEMS

FEATURES & BENEFITS

Most Advanced

- The most sophisticated controller used for hot gas defrost applications
- Optimizes performance with changing conditions. There is no need to seasonally adjust settings!
- Sensors gather information and assess the condition of the system to defrost more efficiently

Most Versatile

- Performs exceptionally in all ambient conditions because the controller automatically adjusts to operate efficiently and effectively. Traditional systems often have to be adjusted by hand twice a year.
- Service switch, which allows the system to “sleep” until needed next, is perfect for seasonal agricultural applications.

Simplest to Use

- Control board is preset with factory settings optimized for model size and refrigerant type. No programming is required!
- Basic and expert menu modes allow for flexibility for various degrees of expertise

Lowest Maintenance

- No valves or times to adjust for seasonal conditions
- No water tank to maintain or check for leaks
- Advanced troubleshooting keeps you in the know all the time, with a minimal amount of effort.
- Special Evacuation Mode opens all necessary valves

Best Investment Protection

- Controller is customized to operate within the specified operation envelope, ensuring the safest and most efficient performance

- No guesswork is involved in the system settings, so you do not have to compromise the integrity of your product
- Detailed error and alarm codes greatly reduce troubleshooting time

Compatible With Heatcraft Remote Refrigeration Control

- Web based remote monitoring and control service offering that provides instant access 24/7 to real time refrigeration system status and information

SYSTEM COMPONENTS

Electronic Control Board

- Controller completely manages timing and sequence of defrost
- Automatically compensates for changes in outdoor temperatures
- Monitors all pressures, temperatures, and set points in real time
- Easily programmable through a menu driven interface
- Conformal coated to handle the toughest conditions
- LED indication on the board clearly shows system status
- Remote alarm notification

Vertical Discharge Condensing Unit

- Available Models: 6-30 HP low temperature and 7-40 HP medium temperature
- Featuring Discuss semi-hermetic compressors

Evaporators

- One or two medium profile evaporators or large unit coolers per system

For more information, please contact your local Sales Representative or Account Engineer.



OTHER PRODUCTS & SERVICES

Two-Stage Condensing Units & Systems

Two stage condensing, units with Bitzer compressors, matched with 1 or 2 Medium Profile evaporators are designed for applications requiring a suction temperature below -40° F SST. The two stage system can operate down to -65° F SST which allows for room temperatures down to -50° F. These systems are ideal for blood, plasma, pharmaceutical, food and various other storage needs.

Certifications

ETL-508a listed control panel



■ 5 - 30 HP

STANDARD FEATURES

Condensing Unit

- Bitzer two stage compressor
- Discharge and suction vibration eliminators
- Discharge muffler
- Encapsulated high pressure switch
- Adjustable low pressure switch with superhose
- Crankcase heater and crankcase pressure regulator
- Compressor contactor w/circuit breaker
- Floating Tube™ coil design
- Flooded head pressure controls
- Pressure fan cycling (multiple fan units)
- Oil separator - return line solenoid valve and time delay
- Mechanical subcooler
- Replaceable core liquid line filter drier
- Suction accumulator and replaceable core suction filter
- Defrost timer
- Defrost heater and evaporator fan contactors with fusing
- Phase monitor, anti short cycle timer, and pumpdown switch

Evaporator

- Thermo-Flex™ coil design
- Thermostatic expansion valve factory installed
- Liquid line solenoid valve factory installed
- Low temperature motors
- Double wall insulated drain pan
- Adjustable defrost termination and fan delay

For more information, please contact your local Sales Representative or Account Engineer.



OTHER PRODUCTS & SERVICES

FlexPack™

FlexPack™ multiple compressor condensing units offer the flexibility for a wide range of applications. The modular design accommodates up to three compressors (1/2 to 6 HP Hermetic or Scroll), is available in 230/1/60 or 230/3/60, and with R-407A/C/F, R-448A/R-449A and R-404A models for medium or low temperature applications. Perfect for restaurants and convenience stores where remote condenser circuits are needed for ice machines, drink dispensers, display cases and more, this product significantly reduces air conditioning energy costs by reducing the heat load in the space. Features of this line provide outstanding results for the refrigeration system and bottom line.



5 - 18 HP

FEATURES AND BENEFITS

Flexible Design

- Modular design accommodates up to 3 compressors (1/2 to 6 HP Hermetic or Scroll)
- System capacity range from 5 to 18 HP (dependent upon cabinet size)
- Small footprint
- Rooftop AC style appearance to blend with existing equipment

Reduced Installation Costs and Easy Serviceability

- Hinged access panels to refrigeration and electrical components
- Single roof penetration
- Single-point main power
- Clean and intuitive electrical and piping layout

Durable & Reliable

- 14-gauge galvanized steel frame
- Industrial grade, painted galvanized steel
- 1-year parts warranty
- 4-year optional compressor warranty

Increased Energy Efficiency & Reduced Sound

- Remote condenser circuits reduce heat load into space resulting in lower air conditioning energy costs
- Recessed, vertical-discharge, flush-mounted 18" fans with 1100 RPM motors reduce noise levels

COMPONENTS

- Fixed high pressure switch
- Fixed low pressure switch on medium and high temperature compressor modules
- Adjustable low pressure switch on low temperatures modules
- Suction service ports on all modules
- Suction accumulator (CS & CF extended temperature compressors)
- Vertical receiver in 6" x 12" or 6" x 27" sizes
- Sealed type liquid line drier and suction filter
- Head pressure control valve
- Aluminum fin coils
- Crank case heater
- Sight glass

OPTIONS

- Beacon II Refrigeration System available
- Defrost timer (air or electric)
- Individual compressor circuit breakers or fuses
- Unit fused disconnect
- Copper finned coils
- Polyester coated fins
- Liquid line solenoid valve
- Adjustable low pressure switch on high and medium temperature compressors

For more information, please contact your local Sales Representative or Account Engineer.



OTHER PRODUCTS & SERVICES

Air Handlers

Air Handler units are available in sizes 03 through 75 tons in multiple cabinet styles. This equipment is engineered and built to fit your unique project requirements. Whether it is cooling, heating, or ventilation, multiple coil types and accessories are available to meet specific application needs.



■ 3 - 75 TONS

STANDARD FEATURES

Basic Cabinet

- Fan section and a coil section with double wall drain pan.
- Galvanized steel with 1" - 3/4 pound density mat faced fiberglass insulation.
- All fan sections have hinged and latched access doors.

Fan Section

- Motors mount inside of cabinet.
- All units have a single fan design (either forward curved or airfoil)
- Single, double width, double inlet fan wheels for quiet performance and low energy consumption
- Fans are statically and dynamically balanced in fan section before the unit leaves the factory
- Fan bearings are ball bearing type selected for 200,000 hour average life.

Coil Section

- A wide variety of coil types to meet the load requirements of conditioned spaces including water, direct expansion, heat reclaim and steam coils.

Accessories

- Electric Heaters and remote control panels
- A wide variety of filter sections: flat, high capacity, and high efficiency
- Economizer sections
- Internal or external face and bypass damper section

For more information, please contact your local Sales Representative or Account Engineer.



OTHER PRODUCTS & SERVICES

Refrigeration Racks

Providing a high level of design flexibility, racks are offered for indoor and outdoor applications with up to 8 parallel-piped compressors. This equipment is commonly used in cold storage applications. It is engineered and built to fit your unique project requirements and can be used with air-cooled, water-cooled or evaporative-cooled condensers.

Certifications

ETL-508a listed control panel



■ UP TO 320 HP

STANDARD FEATURES

Cabinet

- Larger capacity in a compact footprint
- 3-8 compressors on one frame

Compressor

- Optimum compressor sizing to meet project requirements
- Compressor combination up to 320 HP

Performance & Service

- Single point wiring and piping
- Designed for optimum energy savings, faster installation and reduced maintenance costs
- Controls up to 3 suction groups
- Total project capacity requirements in one unit
- Microprocessor control
- Defrost function flexibility

APPLICATIONS

- Food processing plants
- Blast cooling and freezing applications
- Food and beverage distribution facilities
- Hydrocoolers for produce cooling

For more information, please contact your local Sales Representative or Account Engineer.



OTHER PRODUCTS & SERVICES

Compressor Protection Plan

EXTENDED WARRANTY

CONDENSING UNIT COMPRESSORS

Warranty Item ID	Compressor Horsepower	List Price (\$US)
Hermetic Compressors		
ACH0	0.5-1.0	908
ACH1	1.1-1.9	1,006
ACH2	2.0-2.9	1,107
ACH3	3.0-5.0	1,225
Semi-Hermetic Compressors (Discuss & Reed)		
ACA0	0.5-1.0	1,593
ACA1	1.1-1.9	1,630
ACA2	2.0-2.8	2,429
ACA3	2.9-3.9	2,768
ACA4	4.0-5.9	4,135
ACD5	6.0-6.9	4,959
ACD7	7.0-8.9	5,048
ACD11	9.0-11.9	6,538
ACD13	12.0-14.9	7,887
ACD15	15.0-15.9	10,063
ACD21	20.0-22.0	12,505
ACD25	25.0-27.0	15,370
ACD30	30.0-30.9	16,467
ACD35	35.0-35.9	17,165
ACD40	40.0-40.9	17,977
ACD50	50.0-50.9	21,020
Scroll Compressors		
AZL1	1.0-1.9	1,691
AZL2	2.0-2.9	1,717
AZL3	3.0-3.9	2,220

Warranty Item ID	Compressor Horsepower	List Price (\$US)
AZL5	4.0-5.9	2,318
AZL6	6.0-6.9	2,390
AZL7	7.0-8.9	3,969
AZL11	9.0-11.9	4,250
AZL13	12.0-14.9	5,060
AZL15	15	5,174
Scroll Compressors LG Model		
AZG1	1.0-1.9	1,691
AZG2	2.0-2.9	1,717
AZG3	3.0-3.9	2,220
AZG5	4.0-5.9	2,318
AZG6	6.0-6.9	2,390
Bitzer Compressors		
BCSL4	3-4	2,450
BCSM5	5	2,687
BCSM9	6-10	2,796
BCSM12	12	3,780
BCSL13	13	4,607
BCSM15	15	4,495
BCSM20	20	5,149
BCSM22	22	5,383
BCSM25	25	6,548
BCSM30	30-33	6,848
BCSM35	35	7,630
BCSM40	40	8,715
BCSM50	50	9,407

Warranty Item ID	Compressor Horsepower	List Price (\$US)
Bitzer MT Screw Compressors		
BCS50	50	17,256
BCS60	60	18,399
BCS70	70	19,687
BCS80	80	21,494
BCS90	90	23,423
BCS100	100	25,917
BCS110	110	35,143
BCS125	125	36,653
BCS140	140	39,523
Bitzer LT Screw Compressors		
BSCL40	40	51,601
BSCL50	50	55,799
BSCL60	60	58,355
BSCL70	70	61,518

PRO³ COMPRESSORS

Warranty Item ID	Model	List Price (\$US)
WARC0-3	PT0024M* - PT0078M* PT0027L* - PT0036L*	664
WARC1-3	PT0097M* PT0042L* - PT0062L*	676
WARC2-3	PT0115M* PT0069L*	793

Term of Extended Compressor Warranty:

Heatcraft Refrigeration Products LLC (herein after referred to as "Heatcraft") hereby warrants the covered parts and equipment for a period of five (5) years from the date the standard Heatcraft Product Warranty became effective, all as defined below. This warranty shall become effective upon the expiration of the standard Heatcraft Product Warranty applicable to the parts or equipment. As a PRO3 systems and systems with InterLink compressors, the warranty shall be effective for a period of three (3) years following expiration of the standard warranty. As to all other Heatcraft traditional products, this warranty shall be effective for a period of four (4) years following expiration of the stand warranty.

Covered Parts and Equipment:

Covered parts and equipment shall include only the motor-compressor assembly (the "Assembly") consisting of the rotor, eccentric rod, piston, wrist pin, suction valve, discharge valve and the housing in which these parts are enclosed. The warranty does not apply to any other parts or equipment, and, without limitation, specifically excludes any equipment to which the Assembly is connected (such as cooling coils, temperature controls, refrigerant, metering devices, etc.), and any other parts, such as the condenser, receiver, connecting tubing, and electric controls such as relays, capacitors, pressure control or fan and motor assemblies.

Statement of Warranty:

If, during the term of this Warranty, any Assembly is found to be defective in material or factory workmanship under normal use and regular service, Heatcraft will reimburse to the original Purchaser-user, named above, the cost of a replacement Assembly or replacement parts, as applicable, less the fair exchange value of the part found to be defective. A determination of defectiveness shall be made by the nearest compressor wholesaler to which the part shall be delivered for inspection by the Purchaser-user. The

amount of such reimbursement shall not include any charges for freight or for labor of any kind (including, but not limited to, the labor associated with the disassembly, reassembly, repair or other work performed on the equipment), nor for any other expense in connection with such exchange, repair or replacement. Purchaser-user shall establish the amount of reimbursement due by submitting to Heatcraft a true and correct copy of the wholesaler's net invoice and credits for the replacement Assembly or parts. Notwithstanding anything to the contrary herein, in no event shall Purchaser-user be entitled to total reimbursement hereunder exceeding the "limit of Liability" amount reflected below.

Warranty Limitations:

This warranty applies only to the original Purchaser-user, within the boundaries of the United States of America, its Territories and Possessions, and Canada, and is not assignable. The Purchaser-user is that person, persons, association or corporation for whom the assembly is originally purchased and installed. This Warranty does not apply to damage to the Assembly occurring during transit, caused by alterations to the parts or equipment, or caused by fire, accidents, fluctuating electrical currents (such as those resulting from running the equipment on a generator), Acts of God, misuse, abuse, failure to properly service and maintain the equipment pursuant to the manufacturer's instructions, or use of non-approved refrigerants in the equipment. This Warranty is void if the covered equipment is moved from its original installation site, or if the serial number on the Assembly is altered, defaced, or removed.

Heatcraft makes no express warranties other than the warranty specified in its standard Warranty and, to the extent applicable, the Warranty as contained in the extended warranty. All implied warranties, including the implied warranties of merchantability and fitness for a particular purpose are excluded to the extent legally permissible. Heatcraft shall have no liability for incidental or consequential damages (including, without limitation, claims for loss of income or profits).



OTHER PRODUCTS & SERVICES

Extended Service Agreement

Today's commercial refrigeration equipment is high-tech. An equipment failure can result in tremendous expense, if it includes repairs, replacement parts, and labor expenses. Equipment owners can potentially save hundreds and even thousands of dollars with a Heatcraft Extended Service Agreement.*

*Limitations Apply. Subject to Service Net terms and conditions. Risk management is provided by Service Net.

GENERAL INFORMATION

FEATURES AND BENEFITS

Complete Peace of Mind

- Covered repair bills will be paid throughout the term of the agreement*
- Choose the type of coverage required with no deductible to worry about

Buy Tomorrow's Repair Costs at Today's Prices

- Due to outside influences, such as price increases and inflation, repair costs may not remain the same in the future. With an Extended Service Agreement from Heatcraft, equipment owners will have one less worry

Extend Our Manufacturer's Warranty

- Standard coverage is one-year parts. With Heatcraft's Extended Service Agreement, you can extend our manufacturer's warranty for up to five years on parts and labor

What's Covered?

- All Heatcraft evaporators, condensing units, and PRO3 Packaged Systems
- New equipment for up to 5 years. Heatcraft's Extended Service Agreements can be transferred to a new equipment owner for a nominal fee

For more information, please contact your local Sales Representative or Account Engineer.



TERMS & CONDITIONS OF SALE

TERMS OF SALE

ORDER ACCEPTANCE:

All orders must be in writing and are subject to acceptance by SELLER at its principal office.

PAYMENT:

Payment is due net thirty (30) days from date of invoice.

PRICES:

Prices are based on products made to SELLER'S standard manufacturing tolerances. Prices of products are subject to change prior to shipment. SELLER reserves the right to change prices on Buyer's orders to those prices in effect at time of shipment.

FREIGHT ALLOWANCE:

Prices are Ex-Works SELLER's dock, freight allowed on any single purchase order of \$12,000 or more (if the order is solely for parts or if the order is solely for products consisting of equipment and accessories), via lowest common carrier to nearest freight station within continental U.S.A. In addition, Prices are Ex-Works SELLER's dock, freight allowed for multiple orders of less than \$12,000 (if the orders are solely for parts or if the orders are solely for products consisting of equipment and accessories) for which the Buyer schedules consolidation into one shipment equal to or greater than \$12,000 on the same day to one freight station within continental U.S.A. If special routing is requested for such a purchase order of \$12,000 or greater (contract haul, requested flatbed delivery, appointment to meet a crane, etc.), Buyer will be assessed a charge for the difference between such routing and normal minimum freight charge to such point. A purchase order less than \$12,000 or which doesn't meet the \$12,000 criteria or a purchase order that meets the \$12,000 criteria but with shipments to multiple ship-to locations will be shipped Ex-Works SELLER's dock, no freight allowed. Buyer will pay ALL costs associated with the shipment of parts and any orders that are shipped via air freight or expedited delivery. Shipments to destinations outside of the continental U.S.A. will incur charges for the additional cost of transport beyond the U.S.A. border.

DELIVERY:

Any delivery dates which may be indicated herein are estimates only and are not guaranteed.

Unless otherwise agreed, delivery shall be Ex-Works SELLER's dock. As to those products for which SELLER maintains manufacturing facilities in different locations, the point of manufacture will be at SELLER's discretion. SELLER shall be excused for any delay in deliveries or other performance failures due to acts beyond its control, including, but not restricted to, Acts of God or of the public enemy, acts of the Government of the United States or another country, including any preference priority or allocation order, or of any state, territory or possession thereof of any political subdivision or authority or representative of any of them, strikes, lockouts or labor troubles, embargoes, fires, floods, epidemics, quarantine restrictions, explosions, sabotage or other catastrophes or serious accidents, freight embargoes, unusually severe weather, and delays of a subcontractor or supplier due to any such causes.

CREDIT APPROVAL:

If, during the performance hereof, the financial responsibility of Buyer is determined at the sole discretion of SELLER's Credit Department to be unacceptable or if Buyer fails to make any payments in accordance with the terms hereof, then in any such event, SELLER may defer or decline to make any shipments hereunder except upon receipt of satisfactory security or cash payments in advance or SELLER may terminate this order without further obligations of SELLER to Buyer.

TAXES:

Any direct or excise tax which may now or hereafter be imposed by any governmental unit upon the manufacture, sale, or delivery of the goods covered by these terms and conditions may be added by SELLER to the purchase price of such goods, and if so added, shall be paid by the Buyer.

PATENTS:

If any product shall be manufactured and/or sold by SELLER to meet Buyer's particular specifications or requirements, and is not part of SELLER's standard line offered by SELLER to the trade generally, Buyer agrees to indemnify SELLER and hold it harmless from liability, as well as from all costs and expenses, in the event of any claim of patent infringement, whether direct or contributory, arising out of the manufacture of sale of such product, so long as the infringement or claimed infringement does not arise from the combination of the product with anything not provided by SELLER and Buyer promptly notifies SELLER of any such claim and fully cooperates with SELLER.



TERMS & CONDITIONS OF SALE

TERMS OF SALE

CANCELLATION OF ORDER:

Partial or total cancellations of this order by Buyer may be made only upon SELLER's written consent and on condition that SELLER shall be promptly paid an amount determined by SELLER to reimburse it for the costs, losses and expenses resulting from such cancellation. In addition, if Buyer does not release products for shipment within a reasonable time after the date of their manufacture or assembly, SELLER may cancel the order and Buyer agrees to promptly pay SELLER an amount determined by SELLER as liquidated damages and not a penalty, up to twenty percent of the price of the products, to reimburse SELLER for its costs and losses.

RETURN GOODS:

No products shall be returned without SELLER's written permission. Products authorized in writing for return shall be subject to handling and restocking charges determined by SELLER and transportation costs, which Buyer agrees to promptly pay.

PRODUCT CHANGES:

SELLER reserves the right to change specifications, design and material in the interest of product improvement, without incurring obligation to the Buyer. The terms and conditions of an order, which shall include these terms of sale, shall constitute the sole and exclusive agreement between SELLER and Buyer. No waiver of any provision hereof shall constitute a waiver of any other breach or of such provision. Buyer shall comply with all applicable laws, including all export-related laws. The internal laws of the State of Georgia, USA, shall apply.

CLAIMS:

Risk of loss or damage shall in every case pass to Buyer at SELLER's dock. SELLER shall have no responsibility for any claimed shortages or damages. Buyer must (I) notify SELLER of shortages or damages within ten (10) days after receipt of the product; (II) notify agent or carrier within such time of shortage or damage; and (III) file claim with the carrier for the damage or shortage claimed.

WARRANTIES:

SELLER's standard published catalog products warranty ("Warranty"), which is subject to the exclusions and limitations stated in the Warranty, applies to the products and is incorporated into these terms of sale and SELLER's performance of the Warranty is the exclusive remedy of BUYER. SELLER MAKES NO OTHER WARRANTY, EXPRESS OR IMPLIED, ORAL OR WRITTEN, RELATED TO THE GOODS, INCLUDING ANY WARRANTY OF MERCHANTABILITY OR FITNESS FOR A PARTICULAR PURPOSE. SELLER

SHALL HAVE NO LIABILITY FOR ANY INDIRECT, SPECIAL, CONSEQUENTIAL, OR PUNITIVE DAMAGES, INCLUDING ANY LOSS OF PROFIT, AND SELLER'S LIABILITY FOR DIRECT DAMAGES IS LIMITED TO THE AMOUNT PAID BY THE BUYER FOR THE PARTICULAR ITEM OR PART INVOLVED. SELLER OFFERS A NON-TRANSFERABLE OPTIONAL EXTENDED 3- OR 4-YEAR EXTENDED COMPRESSOR WARRANTY IN THE US AND CANADA FOR AN ADDITIONAL COST.

TERMS AND CONDITIONS

1. All orders must be in writing. Manufactured-to-order production will not commence unless a written order is provided.
2. Tax Exemption Certificates must be provided for ship-to designated states, or applicable taxes will be added to invoice.
3. Three or Four-Year Extended Compressor Warranty (Optional and subject to terms):
 - Available within the boundaries of the United States of America, its Territories and Possessions, and Canada, and is not assignable.
 - Replacements through authorized compressor distributors only.
 - within the period of the Warranty - warranty by distributor.
 - three or four years after end of period of the Warranty - supply proof-of-purchase of new compressor to Heatcraft Refrigeration Products Warranty Claims for reimbursement.



TERMS & CONDITIONS OF SALE

ORDERS IN-WARRANTY REPLACEMENT

In those instances where it is necessary for our customers to place in-warranty orders, some standard information must be provided when the order is placed with the Customer Service Specialist, or with Warranty Claims personnel.

- Complete model and serial number of unit involved.
- Original purchaser of equipment, original invoice number or acknowledgment number. If information is not available, further research will be necessary to validate warranty.
- Start-up date of the equipment involved.
- Failure date of the part which is being replaced.

In those instances where the defective item was a stock replacement, the model and serial number of the original unit are not required. Service parts for products out-of-original warranty are warranted for a period of one (1) year from date of original installation or eighteen (18) months from date of shipment by SELLER.

At the time the order is placed with the Customer Service Specialist, a determination will be made if the defective material should be returned.

An invoice will be issued to the customer for the replacement material with a notation concerning if the material can be "field scrapped" or if return to the plant of manufacture is required.

Warranty Claims will process a credit memo offsetting the amount of the invoice, plus any surface freight charges. The warranty in effect for equipment and/or parts does not cover the cost of special freight terms.

SERVICE POLICY AND IN-WARRANTY FIELD REPAIR

Service Policy

The following outline of the Service Policy of SELLER is a complete explanation as to the purpose and administration of the policy.

Field Service Engineers are available for troubleshooting problems related to SELLER's manufactured products only. All requests for on-site assistance in diagnosing service problems will be scheduled at the discretion of the Service Department and only after previous attempts to diagnose equipment problems through direct communications with the installing or servicing agencies have failed.

Advance notice will usually be required to arrange an on-site inspection of the equipment installation by a Field Service Engineer, if SELLER determines that is needed, and the scheduling of the on-site inspection will be subject to the Field Service Engineer's availability. A purchase order from the original customer will be requested and must be on file with the SELLER's Service Department prior to scheduling of the Field Service Engineer. If the Field Service Engineer's inspection indicates the problem is due to installation, service, misapplication, or any situation that is beyond Heatcraft Refrigeration Products' control, the SELLER will invoice the customer against this purchase order at the rate established annually by SELLER (currently, \$740.00 per day) with a two (2) day minimum charge plus all related travel, lodging, sustenance, and incidental expenses.

However, should the inspection reveal that the problem is due to deficiencies in material or workmanship by SELLER, no charges will be owed.

In the event that a Field Service Engineer is dispatched to a job site, it is mandatory that a representative of the customer and/or contractor be present at all times while the Service Engineer is on-site. Additionally, all actual service work must be performed by a qualified licensed refrigeration service technician equipped with the appropriate tools and test instruments. Advance arrangements should be made between the customer and SELLER and communicated to all of the appropriate parties. If this condition is not met, it is at SELLER's discretion as to whether the Field Service Engineer will continue with the job site inspection.



TERMS & CONDITIONS OF SALE

IN-WARRANTY FIELD REPAIR

In some cases where the SELLER believes the customer may be better served, on-the-job repair may be authorized in writing at actual cost for appropriate repair. Specific information must be provided to the Service Department including the complete model and serial number of the equipment involved along with the actual start-up date of the equipment and the name of the original customer and a breakdown of estimated costs to repair. When authorization is given by SELLER personnel, a Field Repair Authorization Number will be issued for an approved, qualified licensed technician to conduct the repairs. This number will reference the estimated costs of repairs plus all pertinent information concerning the equipment. After completion of the repairs, the original service invoice should be sent to SELLER's Field Sales Representative, along with copies of any additional documentation required. The invoice must be complete, showing SELLER as the customer, with a brief description of

all work performed, an itemized breakdown of labor and material, along with the model and serial number of the equipment. The Field Repair Authorization Number should also be noted.

When warranty coverage for repairs is expected from SELLER, the repairs should never be performed without prior written authorization from the Service Department (except during periods of extenuating circumstances which may preclude prior contact). In those instances when field labor is performed without the Service Department's prior written approval, reimbursement may, or may not be allowed. Our normal policy for reimbursement is by credit memo to the original purchaser. Repair or replacement of the product in these instances shall be the sole responsibility of the customer in each case. Repairs to products determined to be beyond the Standard Warranty period will be at the discretion of the customer or end user.

RECAP OF RETURNED GOODS POLICY FOR FIELD DISTRIBUTION

Returned Goods Policy

- **Contact your Sales Representative or the Warranty Claims Department for prior authorization. No product will be accepted for credit without a properly completed authorization tag. The Return Material Authorization (RMA) Number must be marked clearly on the outside of the carton and a copy of the RMA should accompany the returned material.**
- **MANUFACTURED-TO-ORDER (NON-STOCK) UNITS ARE NOT ELIGIBLE FOR RETURN.**
- Goods requested to be returned for restock to Heatcraft Refrigeration Products' inventory must be in a new, unused, and salable condition, in the original cartons, and less than one year from the original invoice date.
- If an item has been field scrapped, no RMA is needed.
- Warranted units and/or parts found to be defective upon Seller's examination will be repaired or replaced. Heatcraft Refrigeration Products will require the following:
 - Complete model and serial number of the unit.
 - Start-up date of unit and failure date of unit.
 - Original invoice or acknowledgment number along with the original equipment purchaser's name.
- If an advance replacement is needed, contact your Customer Service Specialist.
- Goods must be returned prepaid (unless authorized otherwise) within 60 days of date on RMA. Failure to return goods within sixty (60) days may result in:
 1. Refusal of materials.
 2. Loss of credit.



CATALOG PRODUCTS WARRANTY

STANDARD WARRANTY

Seller warrants to its direct purchasers that Products, including Service Parts, shall be of a merchantable quality, free of defects in material or workmanship, under normal use and service for a period of one (1) year from date of original equipment start-up, or eighteen (18) months from date of shipment by Seller, whichever first occurs. This warranty runs to only the original purchaser of equipment or part. Any Products covered by this warranty found to Seller's satisfaction to be defective upon examination at Seller's factory will at Seller's option, be repaired or replaced and returned to Buyer via lowest common carrier Ex-Works Seller's dock. This is buyer's sole and exclusive remedy and, except as provided in the next sentence, seller's sole and exclusive liability in connection with the warranty. Or Seller may, at its sole option, grant Buyer a credit for the purchase price of the defective Product. Buyer must prepay all costs for transportation of Products to Seller's factory.

Seller shall have no liability for expenses incurred for repairs made by Buyer except by prior, written authorization. Any claim under this warranty shall be made to Seller in writing within the warranty period specified above – otherwise such claim shall be deemed waived. Seller shall have no warranty obligation whatsoever if its products have been subjected to alteration, misuse, negligence, free chemicals in system, corrosive atmosphere, accident, or if operation is contrary to Seller's or manufacturer's recommendations, or if the serial number has been altered, defaced, or removed.

THIS WARRANTY IS IN LIEU OF ALL OTHER WARRANTIES, EXPRESSED, IMPLIED OR STATUTORY, INCLUDING, BUT NOT LIMITED TO ANY WARRANTY OF MERCHANTABILITY OR FITNESS, AND ALL OTHER OBLIGATIONS OR LIABILITIES OF SELLER ARE HEREBY DISCLAIMED.

ADDITIONAL WARRANTIES:

The Standard Warranty specified above applies to all Products and Service Parts unless modified by the following:

THERMO-FLEX™ OR FLOATING TUBE™ DESIGN COIL

Seller warrants the Thermo-Flex/Floating Tube Design Coil of the "BM", "BH", "CM", "CH", "HM", "HH", "MM", "ML" or "LH" series of Unit Coolers; coil section of the "BLV", "BDVS", "BBV", "JLD", "JDDS", "JBD", "BDT", "BDN", "BDS", "BDB", "BZT", "BZN", "BZS", "BZB", "CDD", "CDDS", "CDT", "CDN", "CDS", "CZT", "CZN", "CZS", "HDD", "HDDS", "HDT", "HDN", "HDS", "HZT", "HZN", "HZS", "LDV", "LDVS", "LDD", "LDDS", "LDT", "LDN", "LDS", "LZT", "LZN", "LZS" condensing units; and coil section of the "BN", "CN", "HN" or "LN" models of Air-cooled Condensers for a period of five (5) years from shipping date, in the event of any documented and verified (by Seller's representative) leaks in the coil tubes containing refrigerant at the point of and caused by tube contact with the end or center coil support sheets.

Seller will also reimburse the replacement cost of lost refrigerant for a period of five years from the date of shipment from leaks specifically caused by the reasons stated above. The replacement cost will be limited to one full system charge. The warranty specifically excludes leaks at header and weld joints, split tubes or leaks caused by failure to operate the product in accordance with published guidelines for operation and installation of equipment. The cost of replacement refrigerant will be limited to Seller's indexed nationwide average of refrigerant cost per pound. The warranty excludes any fines/fees related to refrigerant leaks.

Air-cooled CONDENSERS "BN", "CN", "HN", "LN" or "NRG" Models

Seller warrants Air-cooled Condensers "BN", "CN", "HN", "LN" or "NRG" Models for a period of two (2) years from date of original installation, or 30 months from the date of shipment by Seller, whichever first occurs.

Optional EC Condenser Fan Motors EC Motors

Five (5) Blade motor assemblies - for a period of three (3) years from date of original installation, or forty-two (42) months from date of shipment by Seller, whichever first occurs.

Unit Cooler EC Fan Motors

Seller warrants EC Motors for a period of two (2) years from date of original installation, or thirty (30) months from date of shipment by Seller, whichever first occurs.

Beacon II™ CONTROL SYSTEMS, Quick Response Controller (QRC) & IntelliGen™ Controller

Seller warrants the Beacon II™ Control System, Quick Response Controller and IntelliGen™ Controller parts for a period of three (3) years from the date of original installation, or forty-two (42) months from the date of shipment by Seller, whichever first occurs.



CATALOG PRODUCTS WARRANTY

ADDITIONAL WARRANTIES:

PRO³ PACKAGED REFRIGERATION SYSTEM:

Seller warrants the PRO³ Packaged Refrigeration System for a period of two (2) years from date of original installation, or thirty (30) months from date of shipment by Seller, whichever first occurs.

HYPERCORE™ Microchannel Coil

Seller warrants the Hypercore™ Microchannel Condenser Coil for a period of two (2) years from date of original installation, or thirty (30) months from date of shipment by Seller, whichever first occurs.

SMART DEFROST KIT™

Seller warrants the Smart Defrost Kit™ for a period of two (2) years from date of original installation, or thirty (30) months from date of shipment by Seller, whichever first occurs.

LG Scroll Compressors Seller warrants the LG Scroll Compressors for a period of two (2) years from date of original installation, or thirty (30) months from date of shipment by Seller, whichever first occurs.

MOTOR COMPRESSORS:

Motor compressor replacements or exchanges shall be made through the nearest authorized wholesaler of the motor compressor manufacturer (not at Seller's factory) and no freight shall be allowed for transportation of the motor compressor to and from the wholesaler. The replacement motor compressor shall be identical to the model of the motor compressor being replaced. Additional charges which may be incurred throughout the substitution of other than identical replacements are not covered by this warranty. An optional, non-assignable, three (3) or four (4) year extended compressor warranty may be purchased for extra cost within the boundaries of the United States of America, its territories and possessions, and Canada. With this extended compressor warranty, replacements are administered by an authorized compressor distributor

only. Replacements within the time period of the standard Warranty (as modified in some instances as stated above) are available through the distributor; for the remaining years, the purchaser must submit a proof-of-purchase of a compressor and supply it to Heatcraft Warranty Claims for reimbursement.

THIS WARRANTY SHALL NOT APPLY:

1. When this equipment or any part thereof is damaged by accident, fire, flood, act of God, alteration, abuse, misuse, tampering, when the original model and serial number plate has been altered, defaced, or removed or used other than the recommended application by Seller.
2. When this equipment or any part thereof is subject to operation on low, high or improper voltages. Low and high voltage is defined as more than a 5% drop below or 10% higher than name plate voltage ratings for single phase equipment or more than 10% drop below or 10% higher than name plate voltage for three phase equipment. NOTE: Proper field supply voltage to the equipment is the responsibility of the owner (end user).
3. To equipment with final destinations unknown to seller as indicated on the original sales order.
4. To labor cost for repair or replacement of parts.
5. To special or expedited freight or shipping charges or to customs duties to any country.
6. If the Warranty holder fails to comply with all the provisions, terms and conditions of this Warranty.

Parts replaced under this Warranty are warranted only through the remainder of the original Warranty.

Extended Service Agreements are provided by a third party not affiliated with Seller. The services provided by the third party are subject to the terms and conditions of the Extended Service Agreements and Seller is not responsible for those services or the third party's performance of its obligations.

IT IS EXPRESSLY UNDERSTOOD AND AGREED THAT SELLER SHALL NOT BE LIABLE TO BUYER, OR ANY CUSTOMER OF BUYER, FOR INDIRECT, SPECIAL, INCIDENTAL, CONSEQUENTIAL OR PUNITIVE DAMAGES, INCLUDING LOSS OF PROFITS, ADDITIONAL LABOR COSTS, LOSS OF REFRIGERANTS OR FOOD PRODUCT, OR ANY INJURY TO PERSON OR PROPERTY CAUSED BY DEFECTIVE MATERIAL OR PARTS OR FOR ANY DELAY OR MISPERFORMANCE IN THE PERFORMANCE DUE TO CAUSES BEYOND ITS CONTROL OR FOR ANY EXPENSES INCURRED BY REASON OF THE USE OR MISUSE BY BUYER OR THIRD PARTIES OF THE PRODUCTS. SELLER'S MAXIMUM LIABILITY FOR DIRECT DAMAGES IS LIMITED TO THE AMOUNT PAID BY THE BUYER FOR THE PARTICULAR ITEM OF EQUIPMENT OR PART INVOLVED.

NOTE: IN THE CONSTANT EFFORT TO IMPROVE OUR PRODUCTS, WE RESERVE THE RIGHT TO CHANGE AT ANY TIME SPECIFICATIONS, DESIGN, OR PRICES WITHOUT INCURRING OBLIGATION.



WARRANTY FAQ

Q: What is Heatcraft Refrigeration's standard warranty?

A: All units sold by Heatcraft Refrigeration Products are covered under the standard catalog warranty. The basic terms of the standard catalog warranty is as follows: Products warranted for one year from date of original installation, or eighteen (18) months from date of original shipment, from Heatcraft Refrigeration Products, whichever occurs first.

Replacement parts used on equipment past warranty terms are warranted for 1 year from date of installation. View Catalog Products Warranty section for more detailed information.

Q: How do I know if my Heatcraft Refrigeration unit is in warranty?

A: Contact Heatcraft Refrigeration Product's warranty department at (800) 537-7775 with the model and serial number of the equipment that was serviced along with the equipment's original installation date.

Q: How do I submit a warranty claim?

A: Warranty claims should be submitted to the original purchaser of your Heatcraft Refrigeration Products equipment. If assistance is needed to identify the equipment's original purchaser you can contact Heatcraft Refrigeration Product's warranty department at (800) 537-7775 with the model and serial number of the equipment that was serviced.

Q: How do I get a warranty claim form?

A: Heatcraft Refrigeration Product currently does not have a warranty claim form. Instead, all warranty claims for Heatcraft equipment are processed through the original purchaser of the equipment serviced.

Q: How do I return material (defective/new and unused)?

A: The original purchaser must receive written permission from Heatcraft Refrigeration Products to return the product. Contact the Heatcraft Field Sales Representative or a Heatcraft Refrigeration Product's warranty representative at (800) 537-7775.

Q: Who do I contact to service my Heatcraft Refrigeration equipment?

A: Heatcraft Refrigeration Products does not have authorized service contractors. A qualified refrigeration service contractor of your choice is permitted to service Heatcraft equipment as needed. All service contractors should contact Heatcraft Refrigeration Products warranty department to confirm warranty status prior to beginning any service related work.

Q: How do I get an "in-warranty" replacement part?

A: You can contact Interlink Parts for in-warranty replacements using one of the following:

By phone at (800) 686-7278 between the hours of 7:30 AM to 4:30 PM Central Time or by email at interlinkparts@heatcrafrpd.com

Q: How do I locate an authorized Heatcraft Refrigeration wholesaler?

A: You can locate authorized Heatcraft Refrigeration Products parts wholesalers in your area by using one of the following:

By contacting a Heatcraft Refrigeration Products Customer Service Representative at (800) 537-7775 between the hours of 8:00 AM to 5:30 PM Eastern Time or by clicking one of the various wholesaler links found on Heatcraft Refrigeration Products Warranty Webpage.

Q: How can I check the status of a warranty claim once submitted?

A: You can contact Heatcraft Refrigeration Product's warranty department at (800) 537-7775. Make sure to have your Heatcraft equipment serial number handy for reference purposes.